

Cellular Injury, Necrosis, Apoptosis

and a few other things..

Causes of cellular injury

- Hypoxia or anoxia
- Physical agents (temperature, pressure, electricity, radiation)
- Chemicals (drugs, poisons, venoms)
- Microbes (viruses, bacteria, fungi, worms)
- Immune reactions, over-reactions
- Genetic defects
- Nutrition (deficiency, imbalance)
- Aging

Mechanisms of cellular injury

- Energy depletion (ATP)
- Mitochondrial permeability transitions
- Rise in cytosolic calcium concentration
- Free radicals, reactive (activated) oxygen species (ROS) oxidize membrane lipids
- Plasma membrane damage and permeability changes
- DNA and protein structural damage

Adaptive responses

- Hypertrophy
 - Increase in size of organs and cells due to protein accretion
 - Response to increased work load (cardiac, skeletal muscle) or hormonal stimulation (uterine muscle)
 - Permanently differentiated cells cannot resume cell cycle to increase their number
- Hyperplasia
 - Increase in cell number and organ size
 - Response to hormonal stimulation or compensatory to damage
 - Cells that normally turn over or issue-specific stem cells resume cell cycle to increase in number—liver, endocrine glands, glandular epithelium, lymph nodes
- Dysplasia
 - Change in cellular organization, size and organ architecture –almost always used to describe changes in epithelium
 - Response to irritation and damage (classic example is Pap smear)
- Metaplasia
 - Substitution of one cell type for another within an organ
 - Response to different concentration or assortment of growth factors or extracellular matrix components, which is a response to irritation or injury
 - Tissue-specific pluripotent or stem cells develop along a different pathway—epithelial or mesenchymal tissues
- Atrophy and/or Hypoplasia
 - Decrease in cell size and number
 - Response to decreased work load (use), hormonal or neuronal stimulation, blood supply, nutrition, or aging; in adults (atrophy) or during development (hypoplasia)
- Aplasia, Agenesis
 - Developmental defects; result of genetic defect or *in utero* deficiency (i.e. folate)

Reversible or Irreversible

- Adaptations may be normal physiological responses to stimuli, or pathological conditions
- Functional or morphological changes in response to stimulus may reverse when stimulus is removed, even if cellular injury has begun:
 - Moderately reduced oxidative phosphorylation of ATP slows active transport
 - Aqueous vacuoles may bud from ER—hydropic change
 - Fatty vacuoles may appear in cytoplasm—fatty change

Reversible damage – cellular swelling

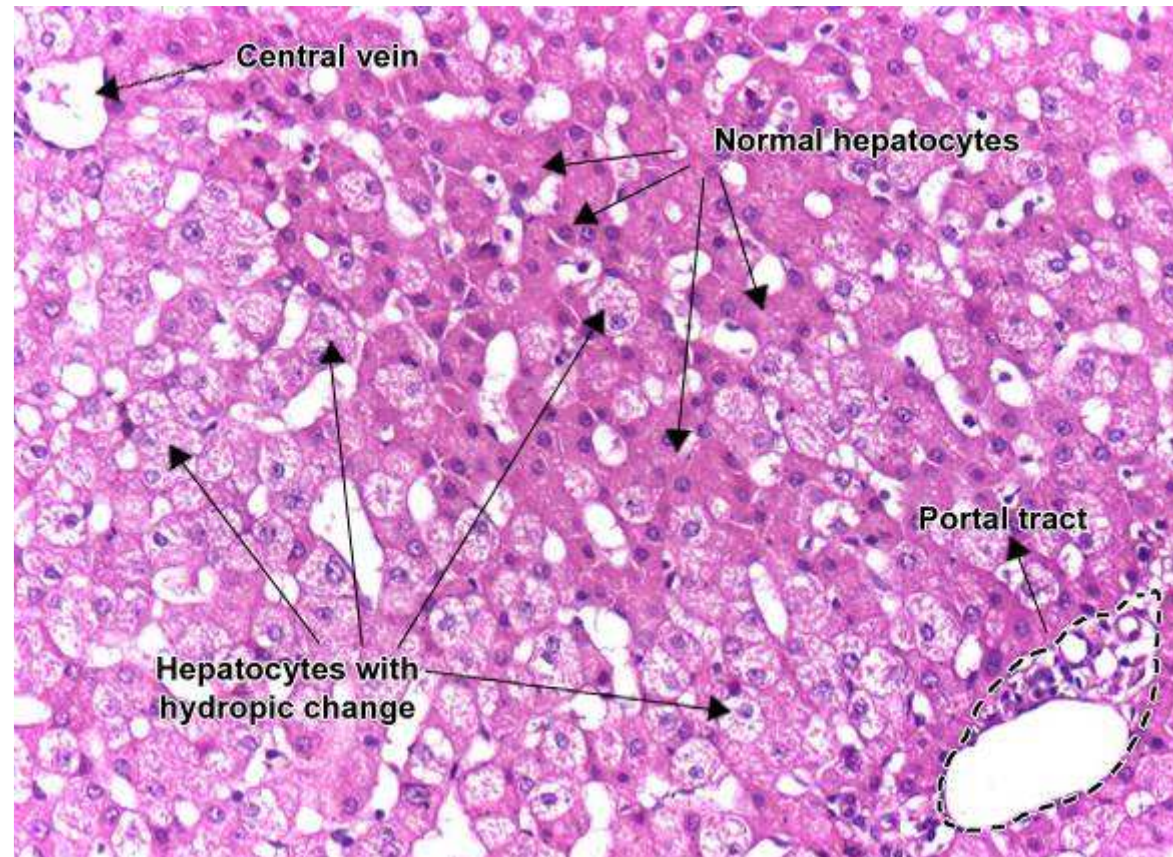

Cellular swelling (synonyms: hydropic change, vacuolar degeneration, cellular edema) is an acute reversible change resulting as a response to nonlethal injuries. It is an intracytoplasmic accumulation of water due to incapacity of the cells to maintain the ionic and fluid homeostasis. It is easy to be observed in parenchymal organs : liver (hepatitis, hypoxia), kidney (shock), myocardium (hypoxia, phosphate intoxication). It may be local or diffuse, affecting the whole organ.

Reversible damage – fatty change

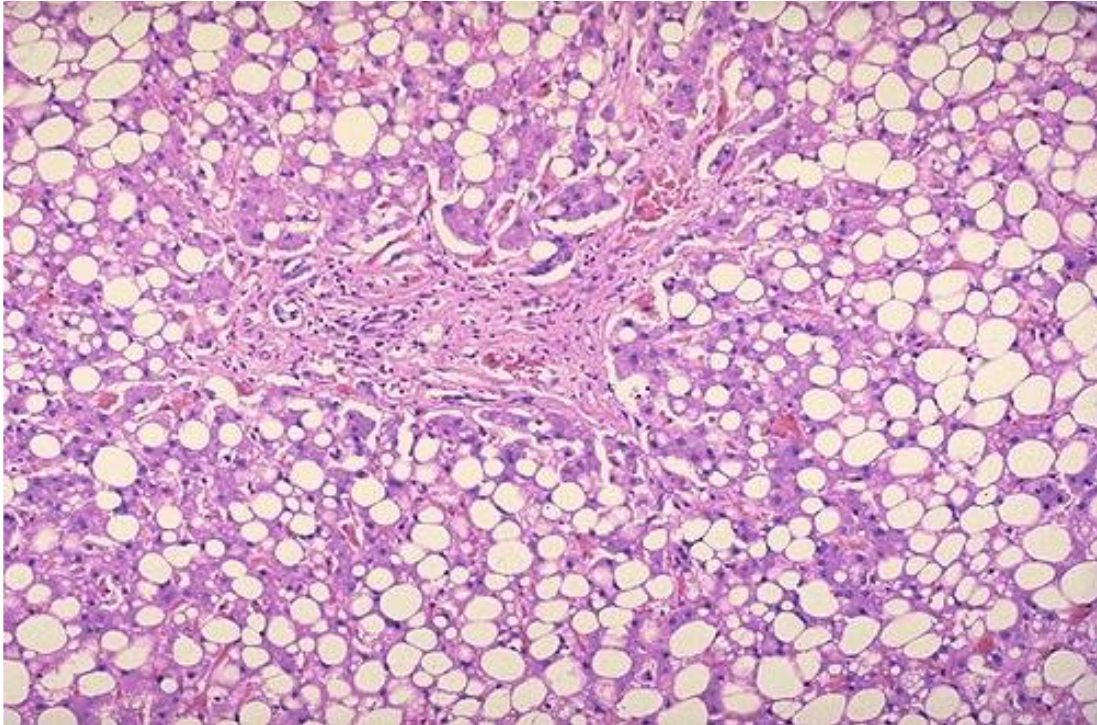

Intracellular accumulations of a variety of materials can occur in response to cellular injury. Here is fatty metamorphosis (fatty change) of the liver in which deranged lipoprotein transport from injury (most often alcoholism) leads to accumulation of lipid in the cytoplasm of hepatocytes.

Reversible or Irreversible?

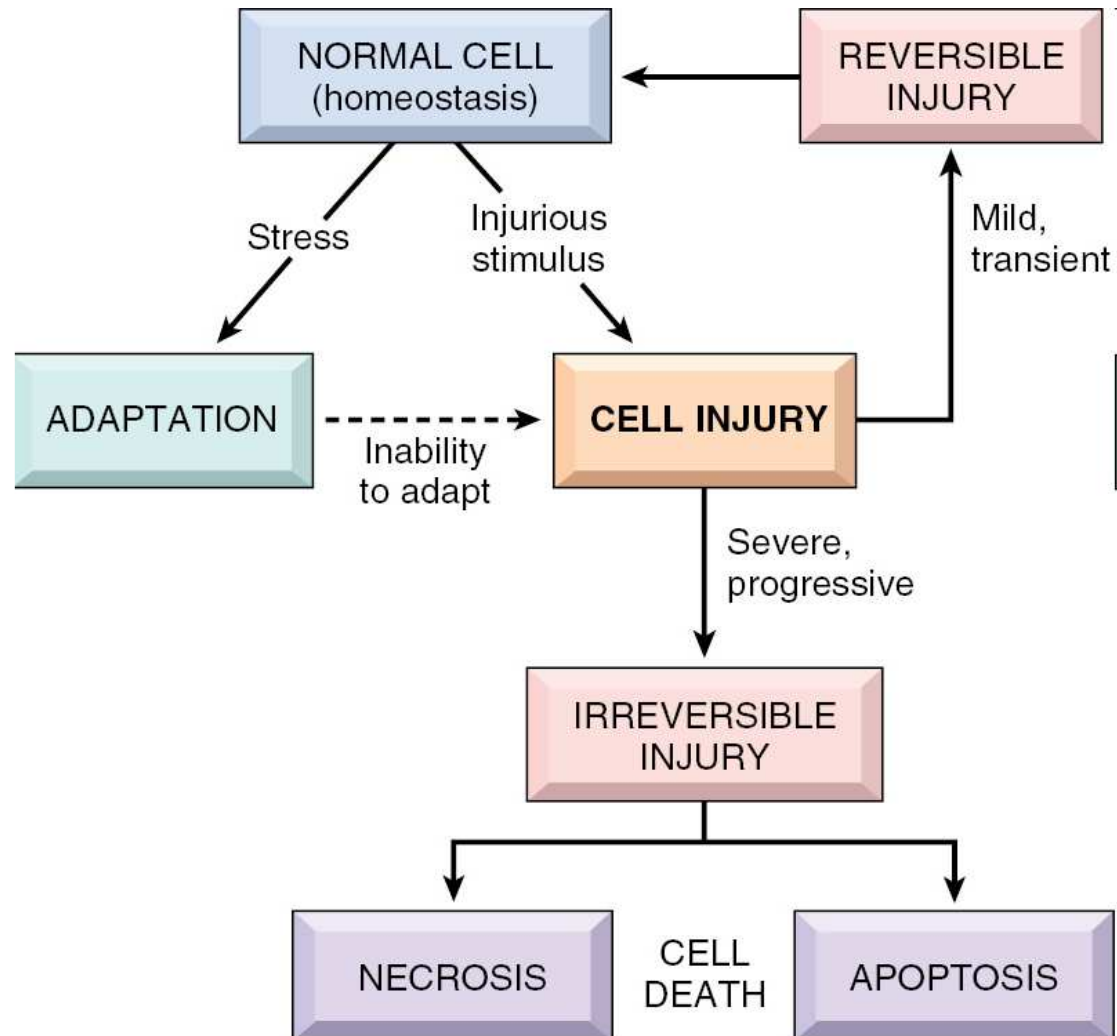

Copyright © 2010 by Saunders, an imprint of Elsevier Inc.

Severe disruption **triggers either necrosis or apoptosis—cells die**

Necrosis

Mechanisms leading to necrotic cells

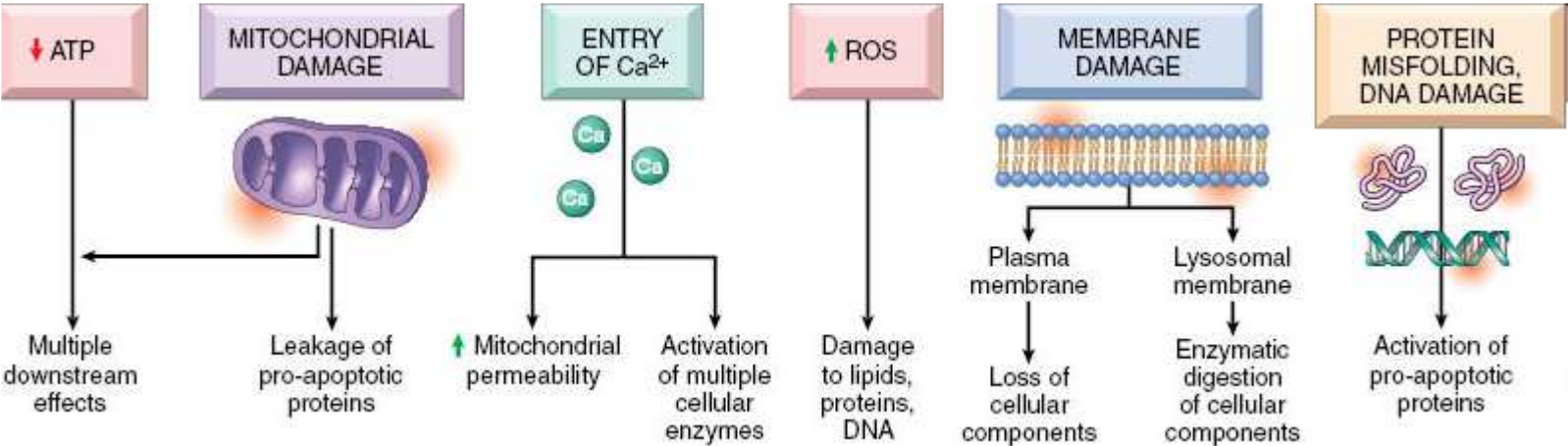

Copyright © 2010 by Saunders, an imprint of Elsevier Inc.

Energy depletion and necrosis

- Inhibition of oxidative phosphorylation
 - Ischemia, mitochondrial damage, toxins
- [ATP] decreases
- Small changes, 5 - 10%, are sufficient to limit the Na/K-ATPase and Ca/Mg ATPase (ionic pumps)
- Glycolytic capacity (glycogen stores) protects from ATP depletion but leads to acidification
 - Plasma and ER membranes swell
 - Enzyme kinetics change; proteins begin to denature
 - Chromatin clumps
- Denatured proteins either coagulate resulting in necrosis or bind HSPs triggering apoptosis

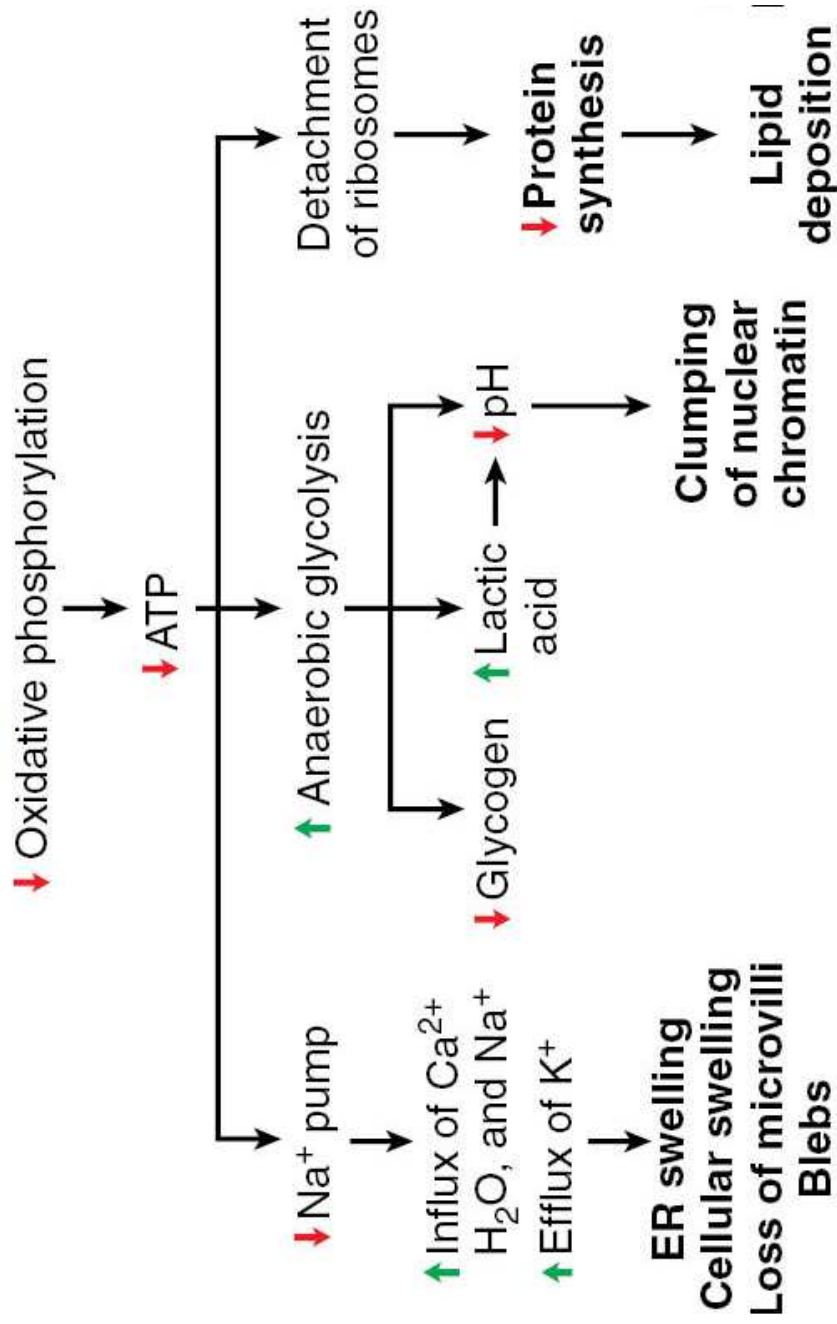
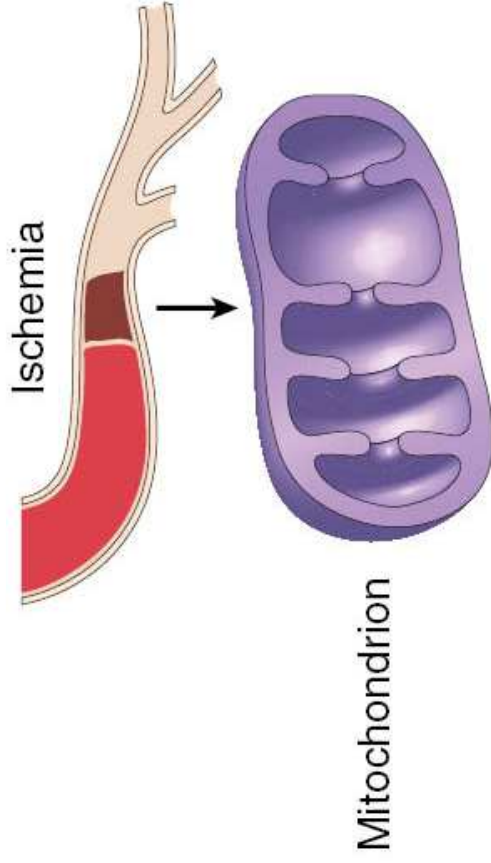

Calcium influx

- Loss of ATP-dependent Ca^{++} transport allows influx from mitochondria, ER, extracellular fluid (Cytoplasmic $[\text{Ca}^{++}]$ is normally 1000 – 10000 times less than extracellular or organellar concentrations)
- Swollen cells have altered cytosolic pH: Proteins are denatured by increased acidity and ionic environment
- Mitochondrial damage and ER swelling further releases Ca^{++} to cytosol
- Ca^{++} activates hydrolytical enzymes: Phospholipase A, ribonucleases, proteases, which degrade membranes, ribosomes, structural proteins

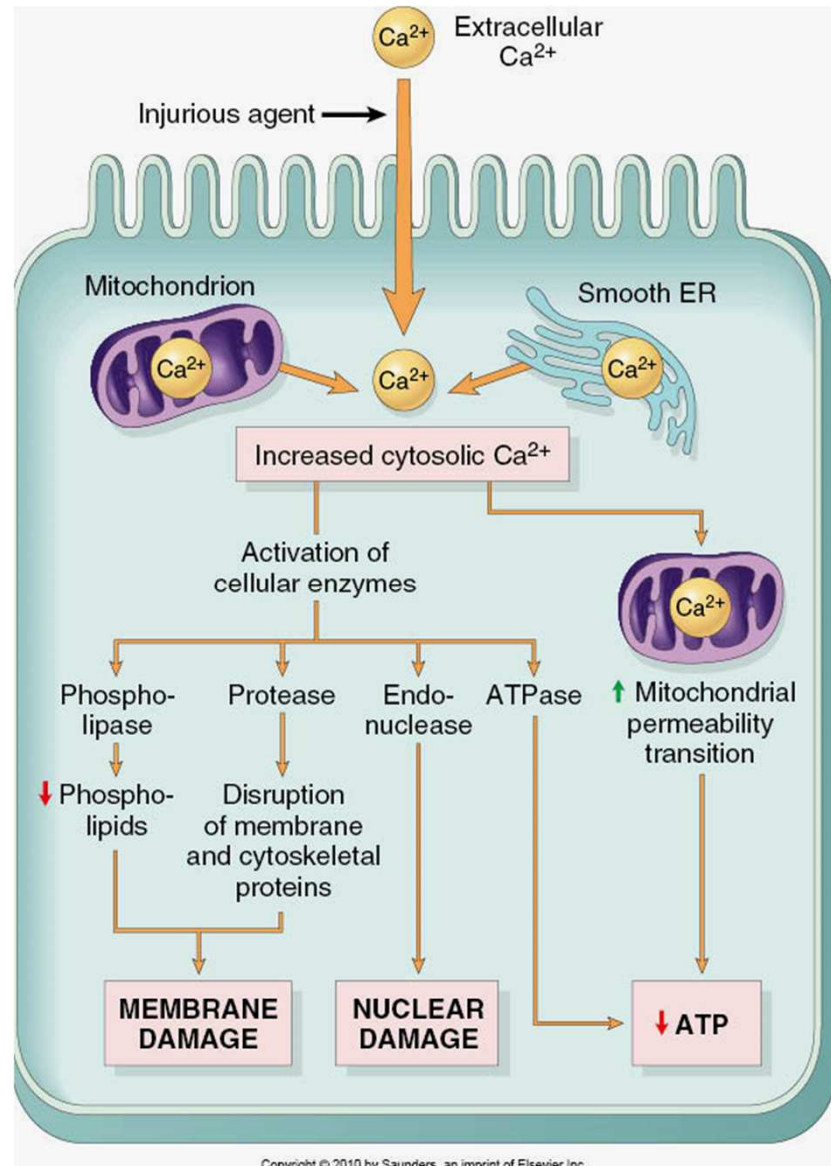

ROS and free radicals

- Superoxide radicals, hydrogen peroxide, lipid peroxides are normally present in small amounts
 - Neutralized by catalase or glutathione peroxidase
- Hydroxyl radicals and hydrogen may be split from water by ionizing radiation
- ROS created and released by neutrophils in response to microbial infection
- Toxic chemicals natively, or after activation by P450 redox in liver or kidney, may result in free radicals
- ROS initiate chain reaction of lipid peroxidation in membranes

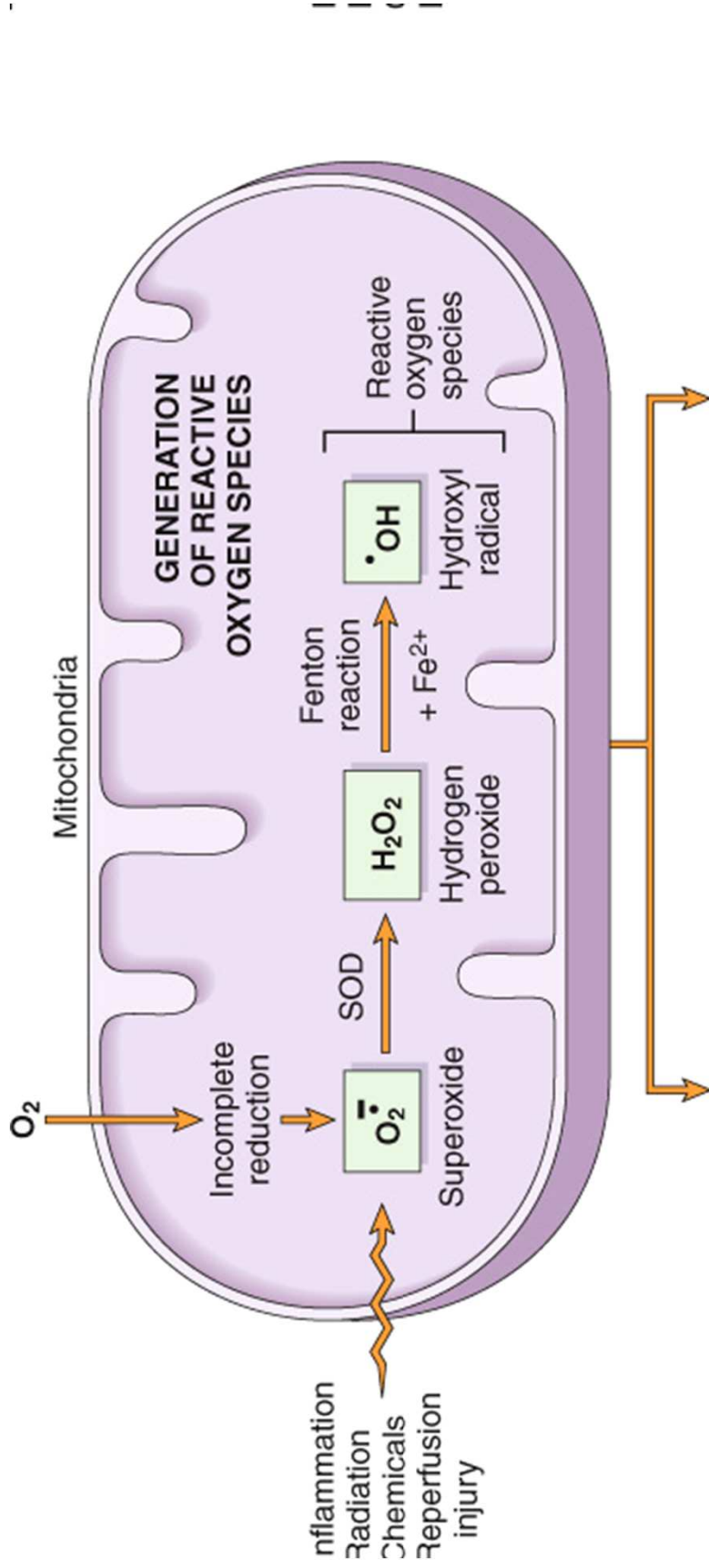

PATHOLOGIC EFFECTS OF ROS: CELL INJURY AND DEATH

ROS react with:

- Fatty acids \rightarrow oxidation \rightarrow generation of lipid peroxidases \rightarrow disruption of plasma membrane, organelles
- Proteins \rightarrow oxidation \rightarrow loss of enzymatic activity, abnormal folding
- DNA \rightarrow oxidation \rightarrow mutations, breaks

REMOVAL OF FREE RADICALS

Antioxidant mechanisms:

- SOD (in mitochondria) converts $O_2^- \rightarrow H_2O_2$
- Glutathione peroxidase (in mitochondria) converts $\cdot OH \rightarrow H_2O_2 \rightarrow H_2O + O_2$
- Catalase (in peroxisomes) converts $H_2O_2 \rightarrow H_2O + O_2$

Necrosis by hypoxia or anoxia

- **caused by:**
- **Oligemia**
 - olig = few; haima = blood
- **Ischemia**
 - ischein = hold back
- **Atherosclerosis**
 - athere = gruel, skleros = hard: hardened lumpy plaque of lipid, lymphocytes and foam cells
- **Thrombosis**
 - thrombus = lump: clot of coagulated blood that forms within a blood vessel or heart chamber and remains at the site of its formation, impeding blood flow
- **Embolism**
 - embolos = stopper: clot or gas bubble that travels from site of formation to block a small vessel

Ischemic injury

- Reduced oxygen tension inhibits ATP production and increases glycolysis, anaerobic respiration
- Increased glycolysis decreases pH, denatures proteins, activates acid proteases and phosphatases
- ATP depletion inhibits active transport of ions across membranes
- Decreased ion transport flattens ion gradients and disrupts osmotic gradients
- Disrupted osmosis results in swelling
- Swelling smooths endoplasmic reticular membranes, decreases protein synthesis, disperses cytoskeletal ultra structure
- **Reversible ischemic injury:** Nuclei remain intact and cells may restore integrity
- Depends on time elapsed and tissue type

Irreversible ischemic injury—infarction

- Necrosis—cell death
- Infarction (*infarcire*, to stuff), localized area of necrosis in a tissue results from anoxia, secondary to ischemia
- Swollen cells have altered cytosolic pH, [Ca⁺⁺], [Na⁺]
- Proteins denatured by increased acidity and ionic environment
- Loss of ATP-dependent Ca⁺⁺ transport allows influx from mitochondria, ER, extracellular fluid (Cytosolic [Ca⁺⁺] is normally 1000 – 10000 times less than extracellular or organellar concentrations)
- Ca⁺⁺ activates degradative enzymes: Phospholipase A, ribonucleases, proteases, which degrade membranes, ribosomes, structural proteins

Necrosis

Trauma (toxic chemicals, mechanical injury, heat, hypoxia)

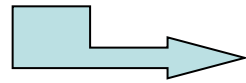

Loss of ability to regulate internal environment

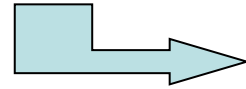

Ca²⁺ influx accompanied by swelling

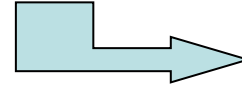

Alteration of protein activity

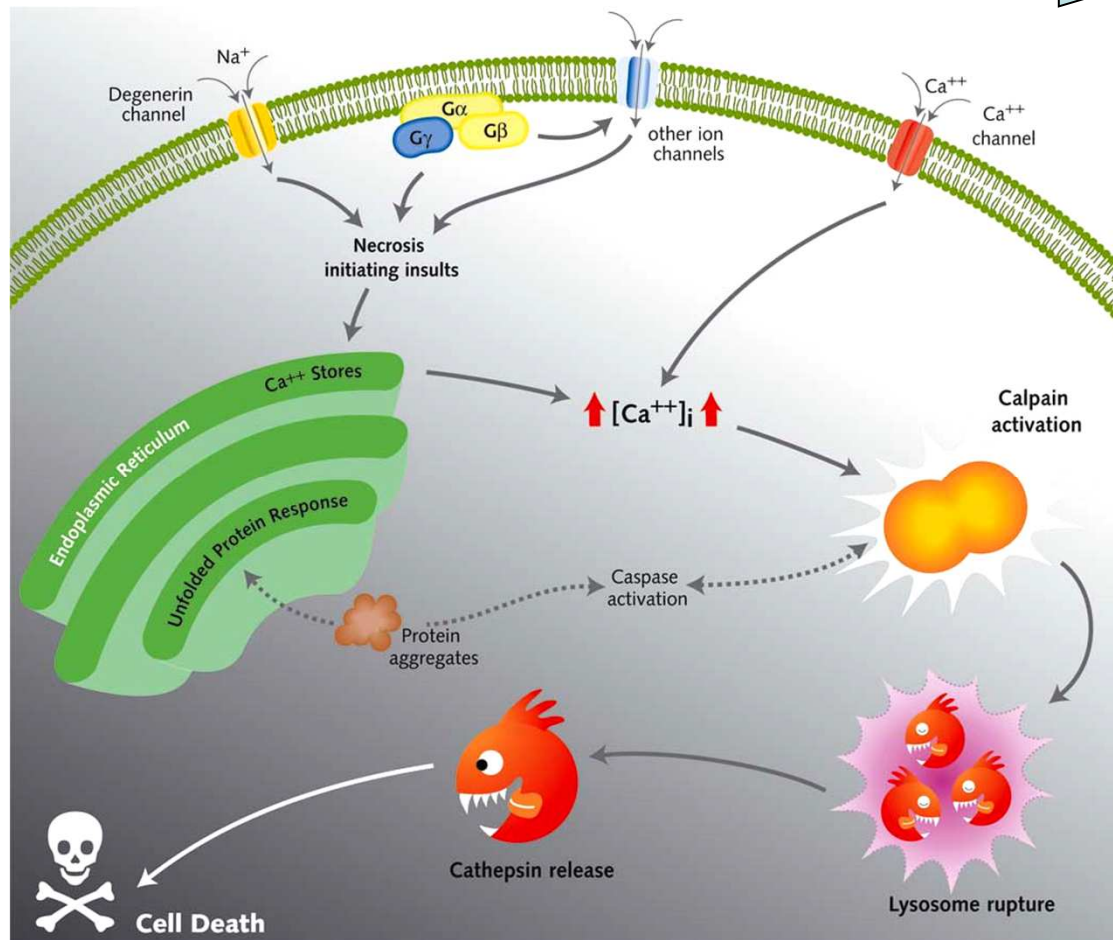

calpain

cathepsin

caspase

Production of toxic compounds

(activation of cyclooxygenases)

arachadonic acid

prostaglandins

eicosanoids

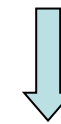

Inflammation

Normal kidney tubules

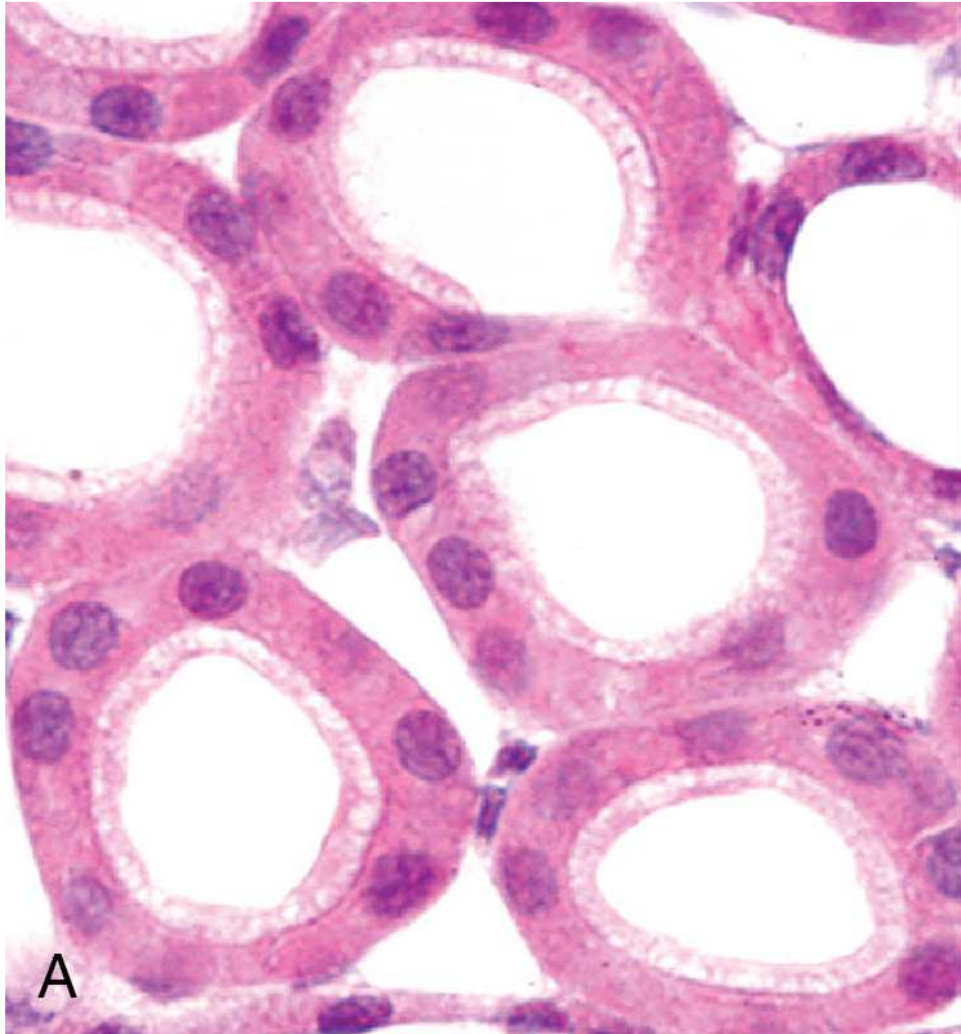

(Courtesy of Drs. Neal Pinckard and M.A. Venkatachalam, University of Texas Health Sciences Center, San Antonio, TX.)

- Epithelial cells stain evenly pink (eosinophilic) in cytoplasm, with purple, basophilic, nucleic acids confined to the nuclei
- Apical surfaces are ciliated
- Interstitia not infiltrated with immune cells nor congested with proteins

Swollen kidney tubules

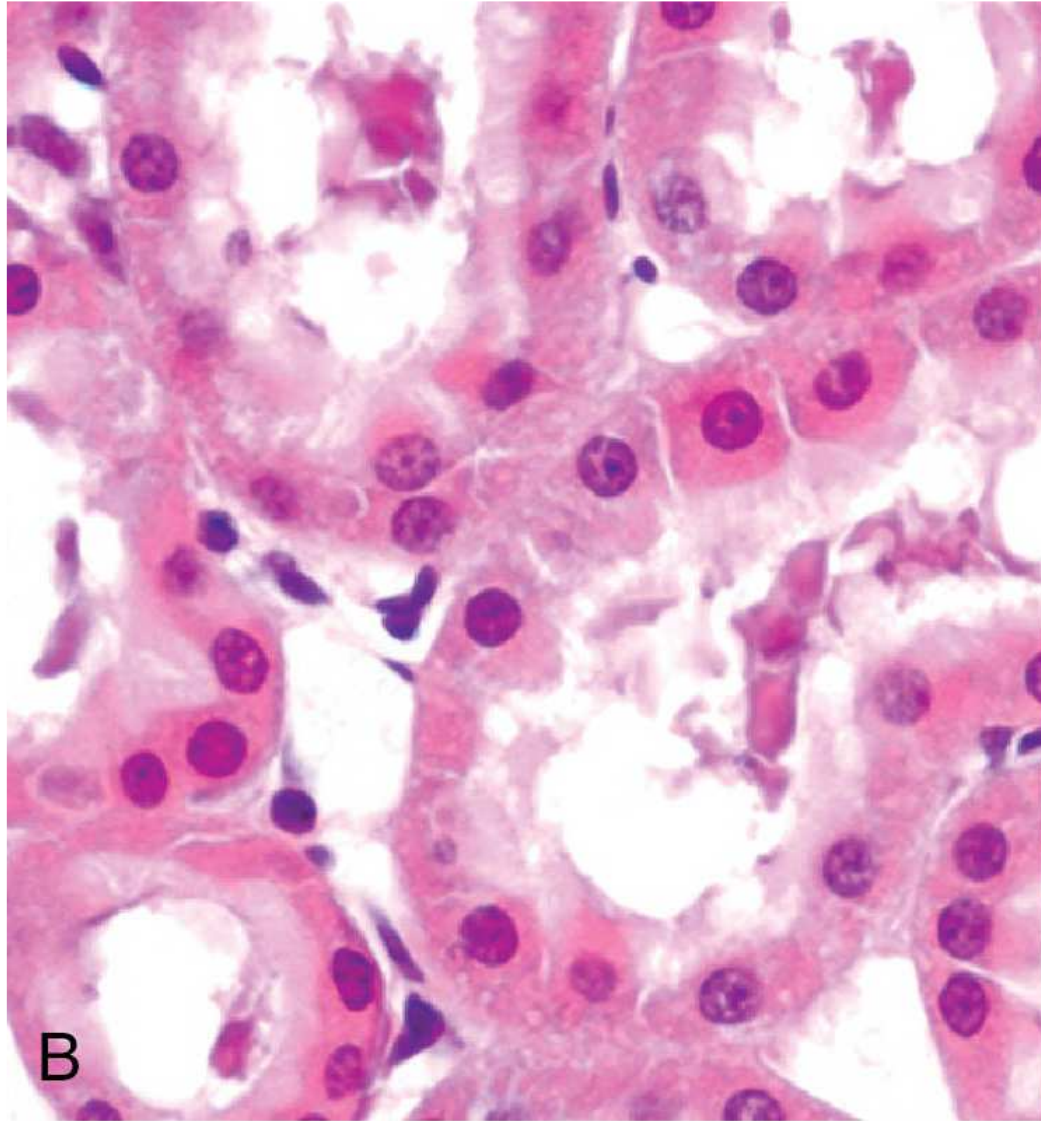

(Courtesy of Drs. Neal Pinokard and M.A. Venkatachalam, University of Texas Health Sciences Center, San Antonio, TX.)

- Increased eosinophilic staining
- Decreased basophilic staining (RNA)
- Plasma membrane rounding, blebbing, loss of cilia, due to loss of connections with cytoskeleton
- Integrity of tubules degrading, but basement membranes intact
- Nuclei largely intact, slightly narrowed, pyknotic

Necrotic kidney tubules

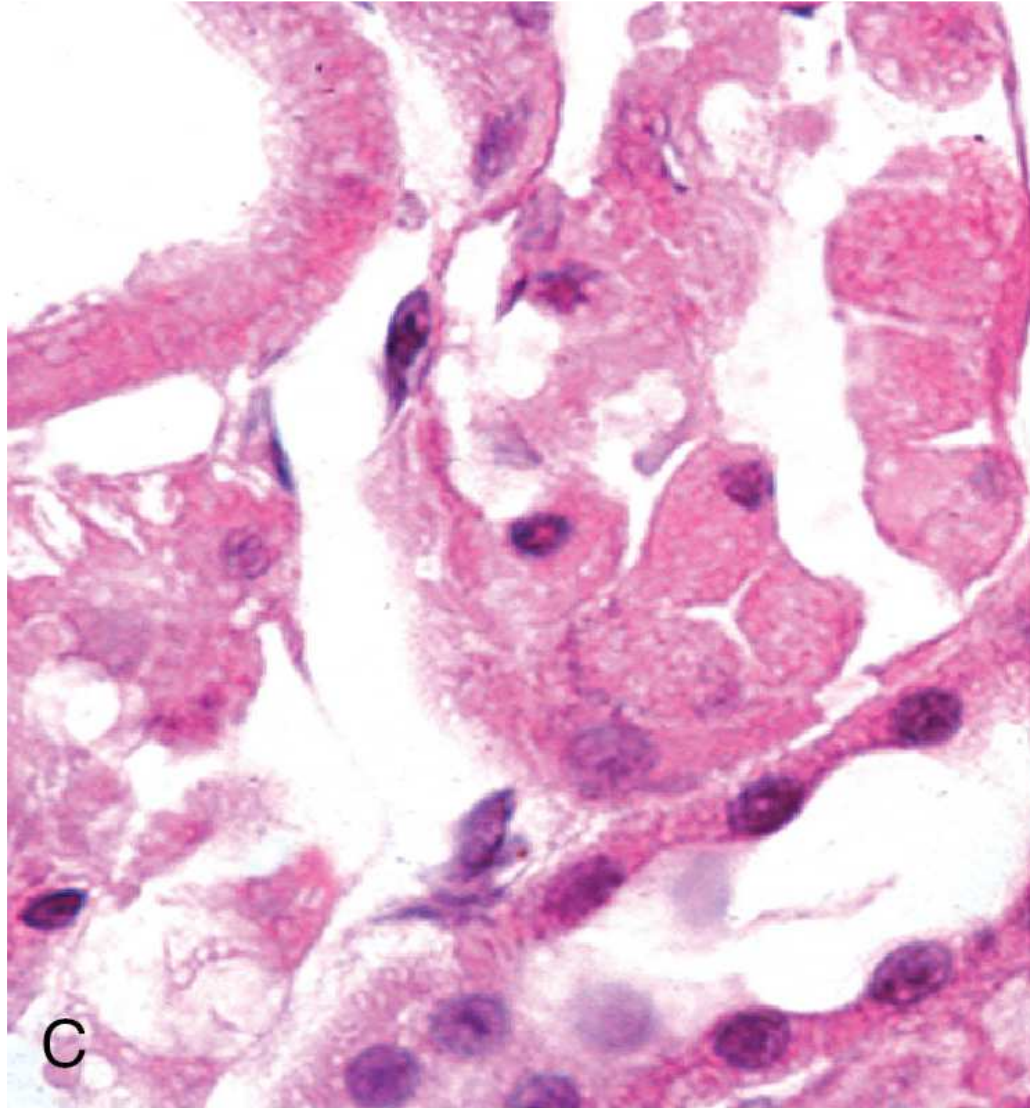

- Cellular fragmentation
- Loss and fading of nuclei--karyolysis
- Burst membranes
- Loss of tissue architecture

(Courtesy of Drs. Neal Pinckard and M.A. Venkatachalam, University of Texas Health Sciences Center, San Antonio, TX.)

Tissue necrosis

- Coagulative necrosis
 - Proteins denature and aggregate rather than degrade
 - Dry gangrene
- Liquefactive necrosis
 - Enzymatic digestion of cellular components
 - Wet gangrene
- Caseous necrosis
 - End result of tuberculous infections, granuloma
- Fatty necrosis
 - End result of pancreatic lipases digesting fat cells resulting in calcium soaps
- Fibrinoid necrosis
 - Ag-Ab complexes and fibrin accumulate in arteries or other vessels

Coagulative necrosis

- Cellular proteins denature (unstick and unwind) due to altered osmotic environment and acidosis
- Anuclear cells stain more deeply pink, tissue retains gross architecture
- Cells burst and are cleared by phagocytes
- Results from hypoxia in tissues other than brain (which liquifies instead)

Coagulative necrosis—myocardial infarction

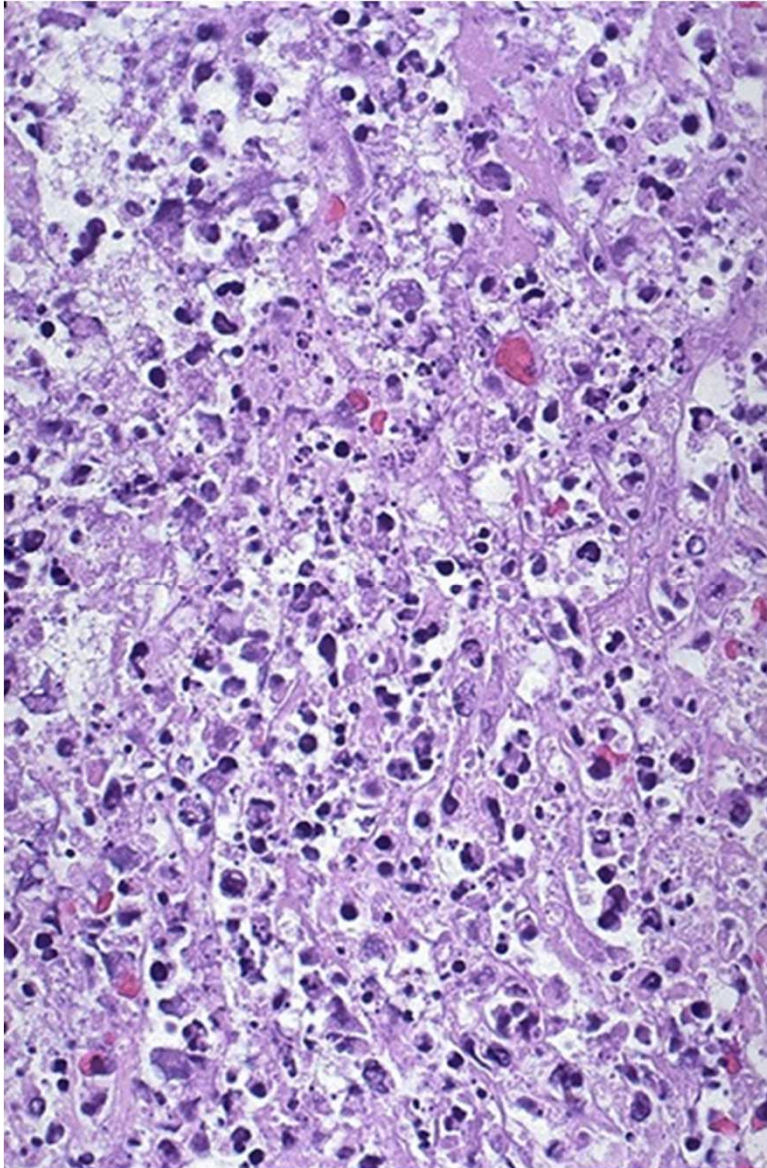

When there is marked cellular injury, there is cell death and necrosis.

Microscopic appearance of myocardium: so many cells have died that the tissue is not recognizable.

Many nuclei have become pyknotic (shrunken and dark) and have then undergone karyorrhexis (fragmentation) and karyolysis (dissolution). The cytoplasm and cell borders are no longer recognizable.

In this case, loss of the blood supply from a major coronary artery led to ischemia and cell death.

Coagulative necrosis—myocardial infarction

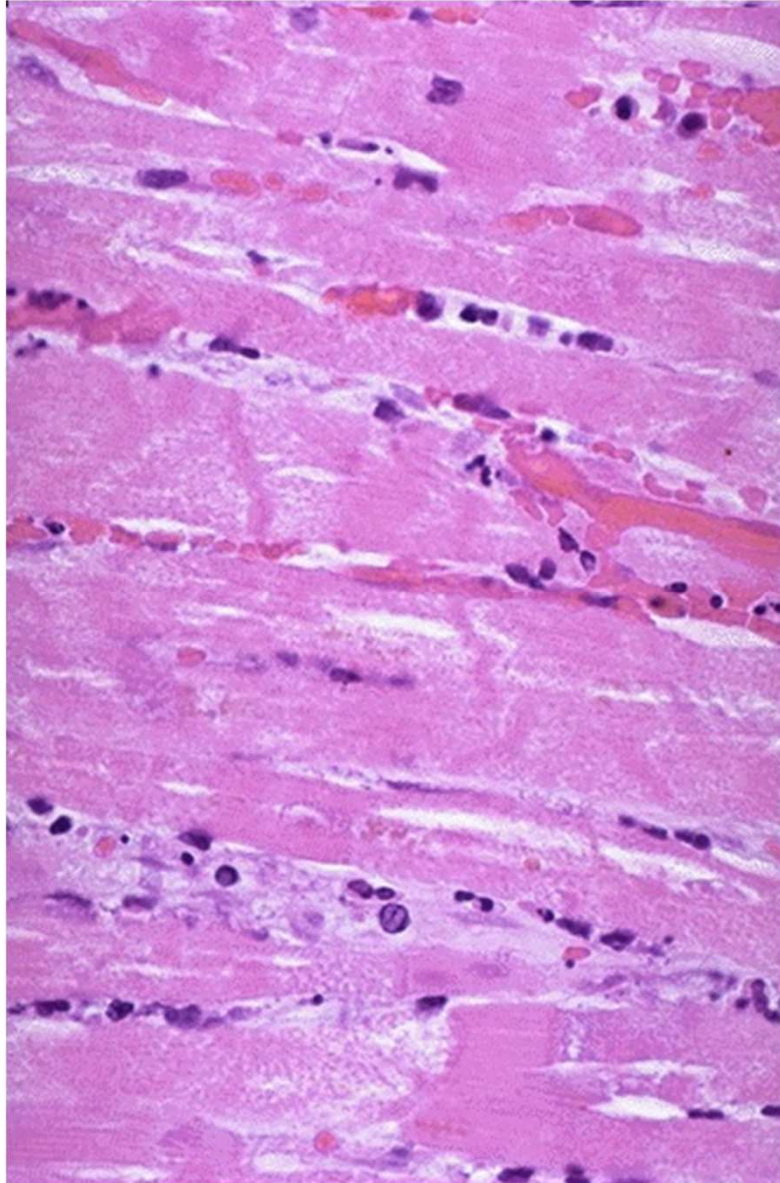

Here is myocardium early in the process of necrosis.

The nuclei of the myocardial fibers are being lost.

The cytoplasm is losing its structure, because no well-defined cross-striations are seen.

Coagulative necrosis—myocardial infarction

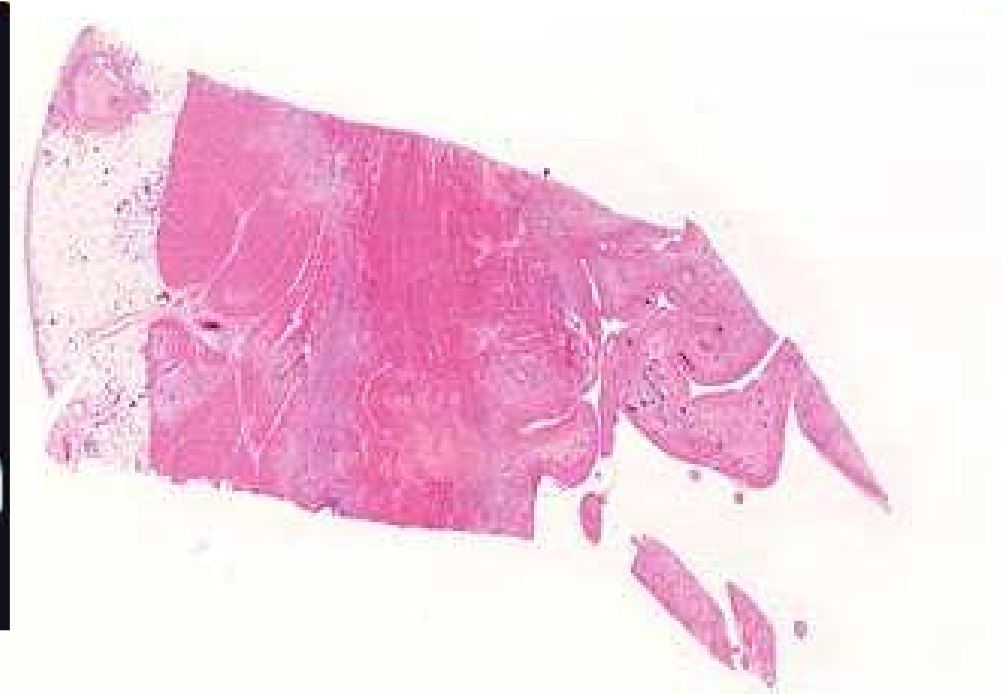

Gross, cross section: A pale, whitish infarct is surrounded by a zone of hyperemia (vascular dilatation).

Very low power glass slide: The area of coagulative necrosis is bright pink compared to the lighter pink viable myocardium. The bluish areas on each side of the necrotic zone represent the granulation tissue response to the necrosis.

Coagulative necrosis—kidney infarction

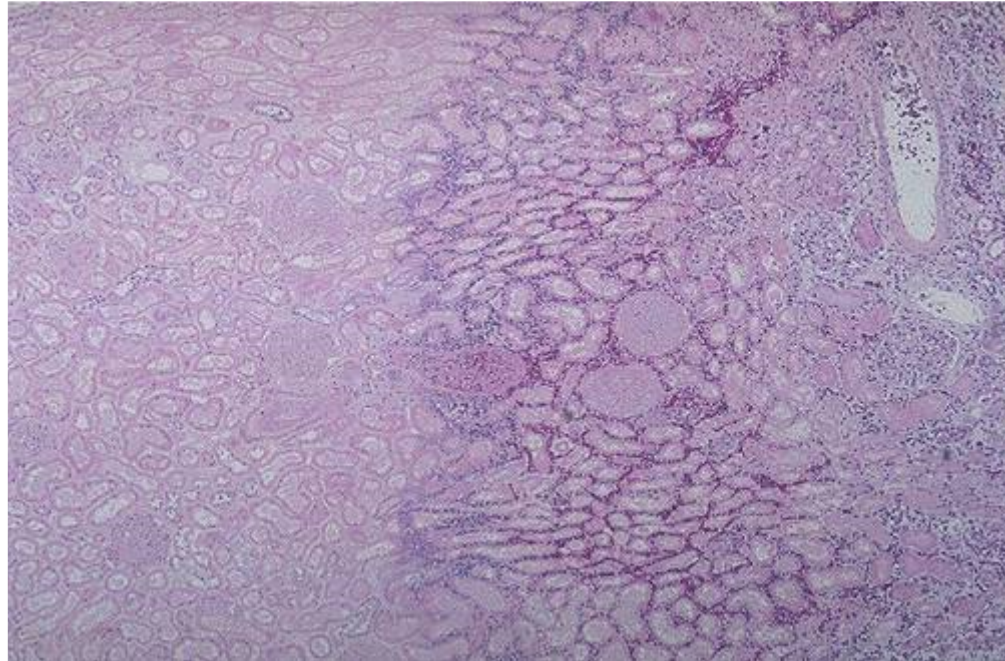
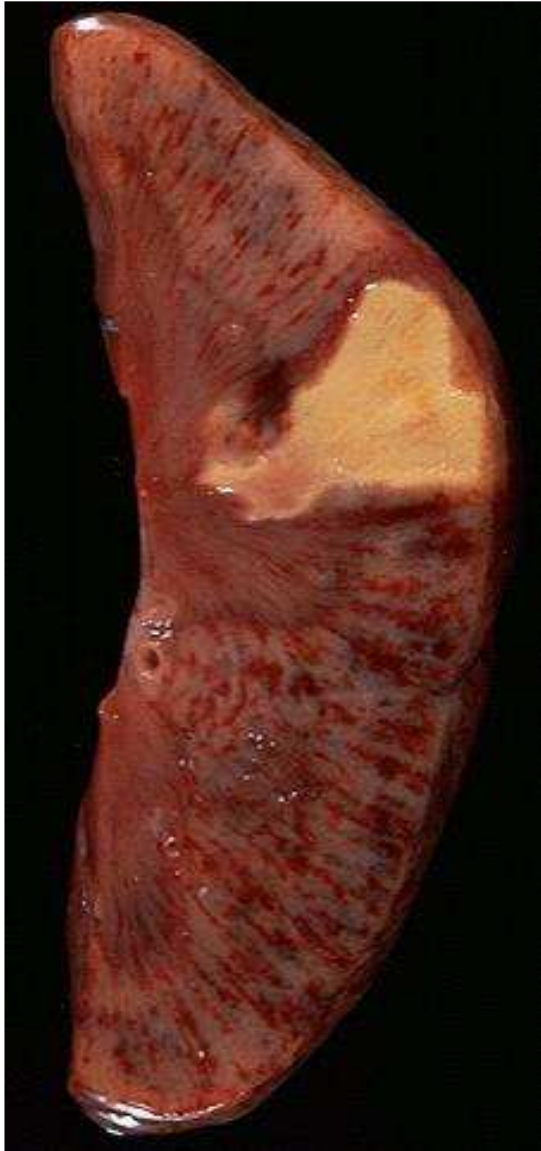

This is the typical pattern with ischemia and infarction (loss of blood supply and resultant tissue anoxia). Here, there is a wedge-shaped pale area of coagulative necrosis (infarction) in the renal cortex of the kidney. Microscopically, the renal cortex has undergone anoxic injury at the left so that the cells appear pale and ghost-like. There is a hemorrhagic zone in the middle where the cells are dying or have not quite died, and then normal renal parenchyma at the far right.

Liquefactive necrosis

- Enzymatic digestion of cellular components
- Infiltration of leukocytes and neutrophils create pus and contribute to hydrolysis of tissue
- Gross tissue architecture lost to degradation of connective tissue
- Serves as substrate for bacterial or fungal growth, sepsis, leading to wet gangrene
- Hypoxic brain injury (infarctions) typically result in dissolution and liquefaction without sepsis, due to high fat content and lack of collagenous connective tissue

Liquefactive necrosis

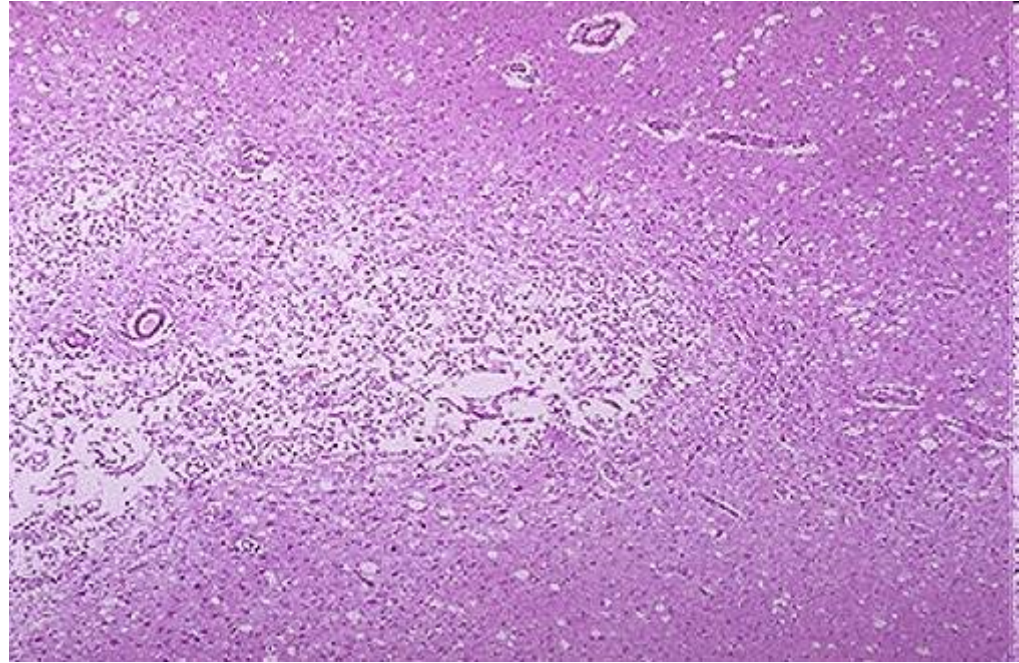
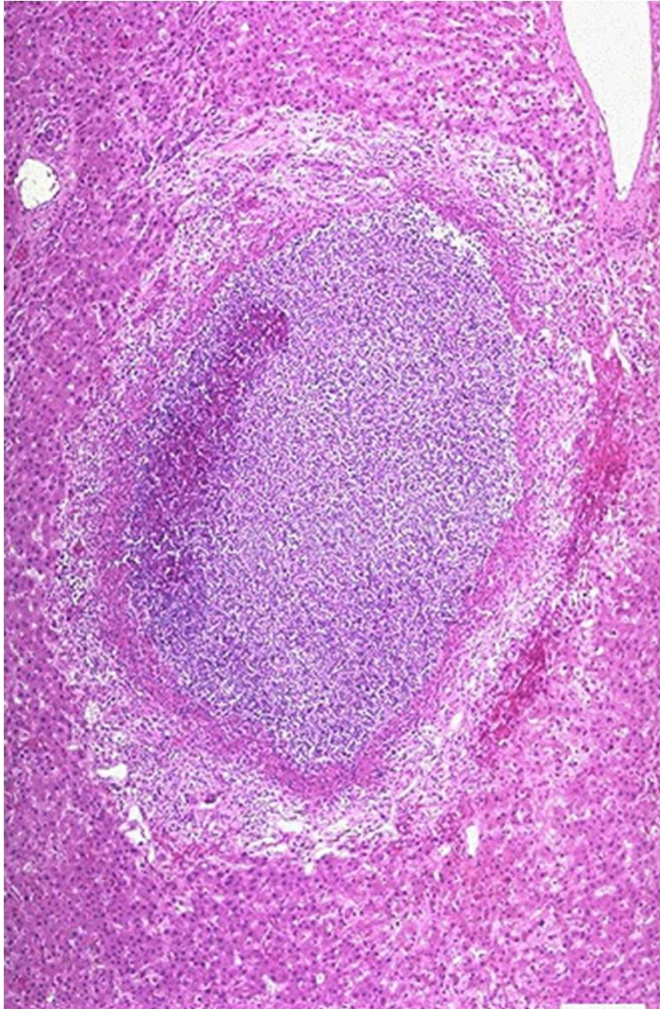

Other necroses

- Caseous necrosis
 - End result of tuberculous infections, granuloma
- Fatty necrosis
 - End result of pancreatic lipases digesting fat cells resulting in calcium soaps
- Fibrinoid necrosis
 - Ag-Ab complexes and fibrin accumulate in arteries or other vessels

Caseous necrosis of lung

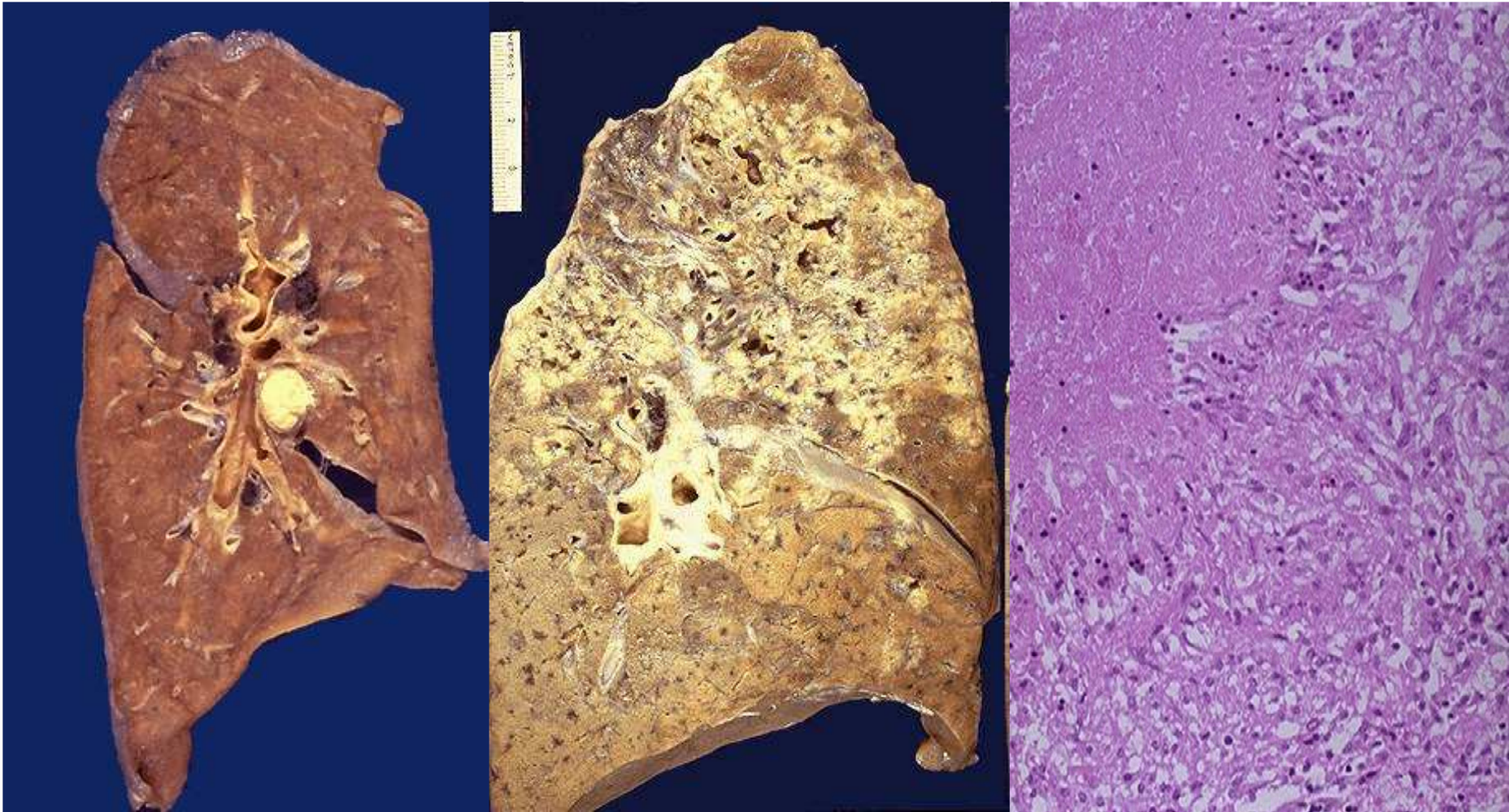

Fat necrosis of pancreas

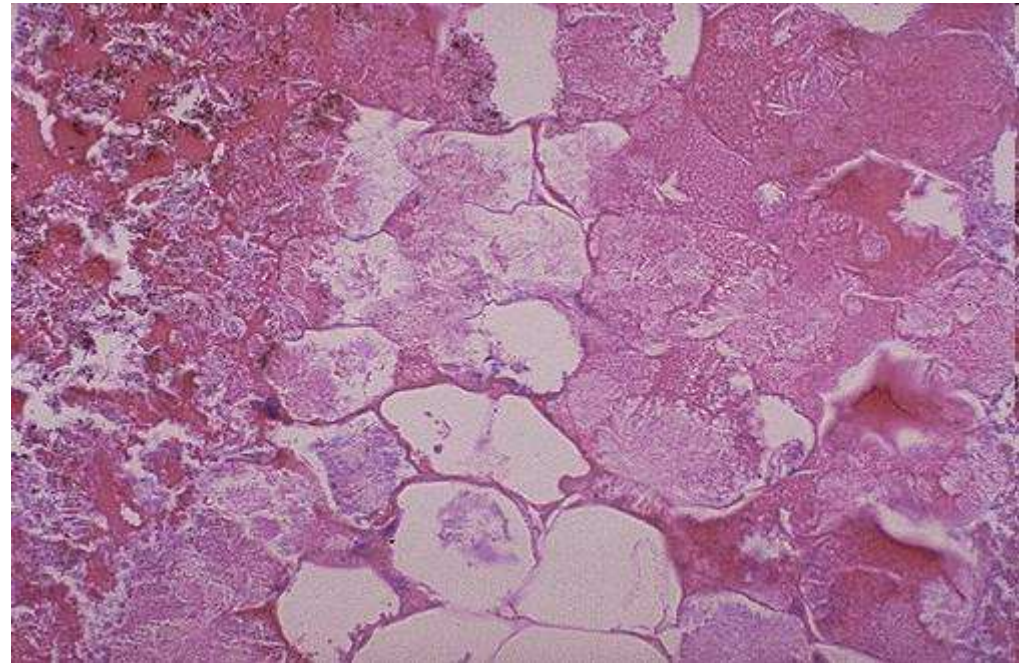
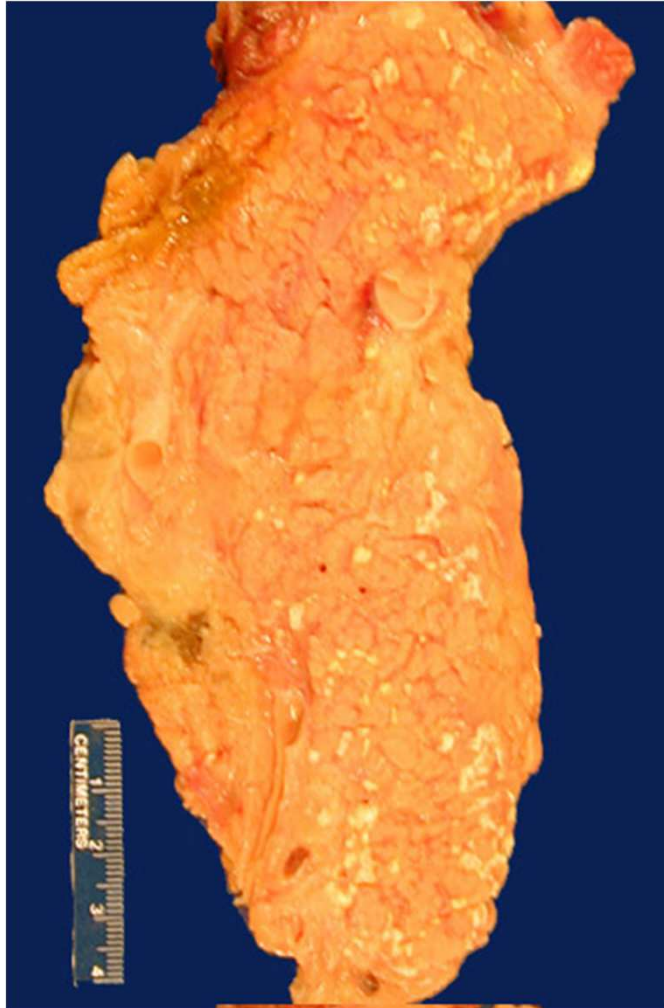

Cellular injury to the pancreatic acini leads to release of powerful enzymes which damage fat by the production of soaps, the chalky white areas seen here on the cut surfaces. Microscopically, the necrotic fat cells at the right have vague cellular outlines, have lost their peripheral nuclei, and their cytoplasm has become a pink amorphous mass of necrotic material. There are some remaining steatocytes at the left which are not necrotic.

Fibrinoid necrosis of vessels

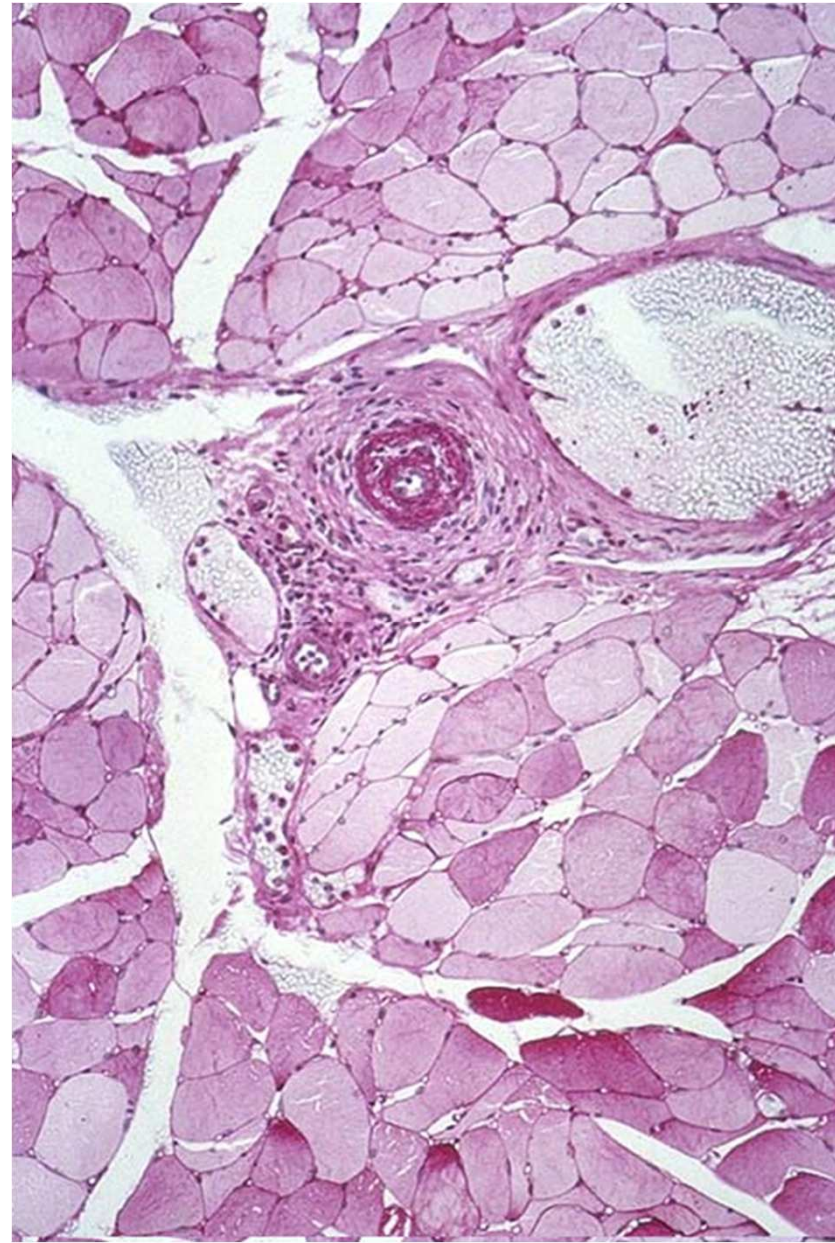
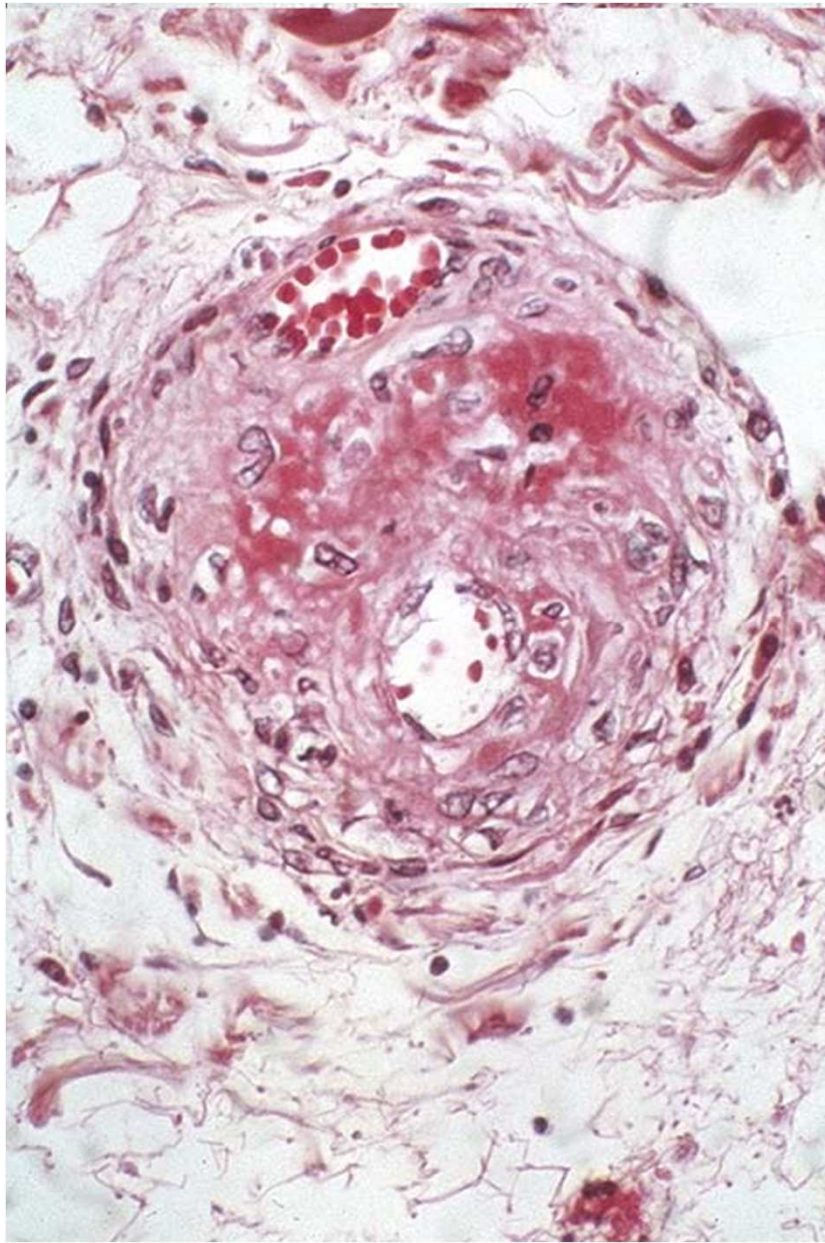

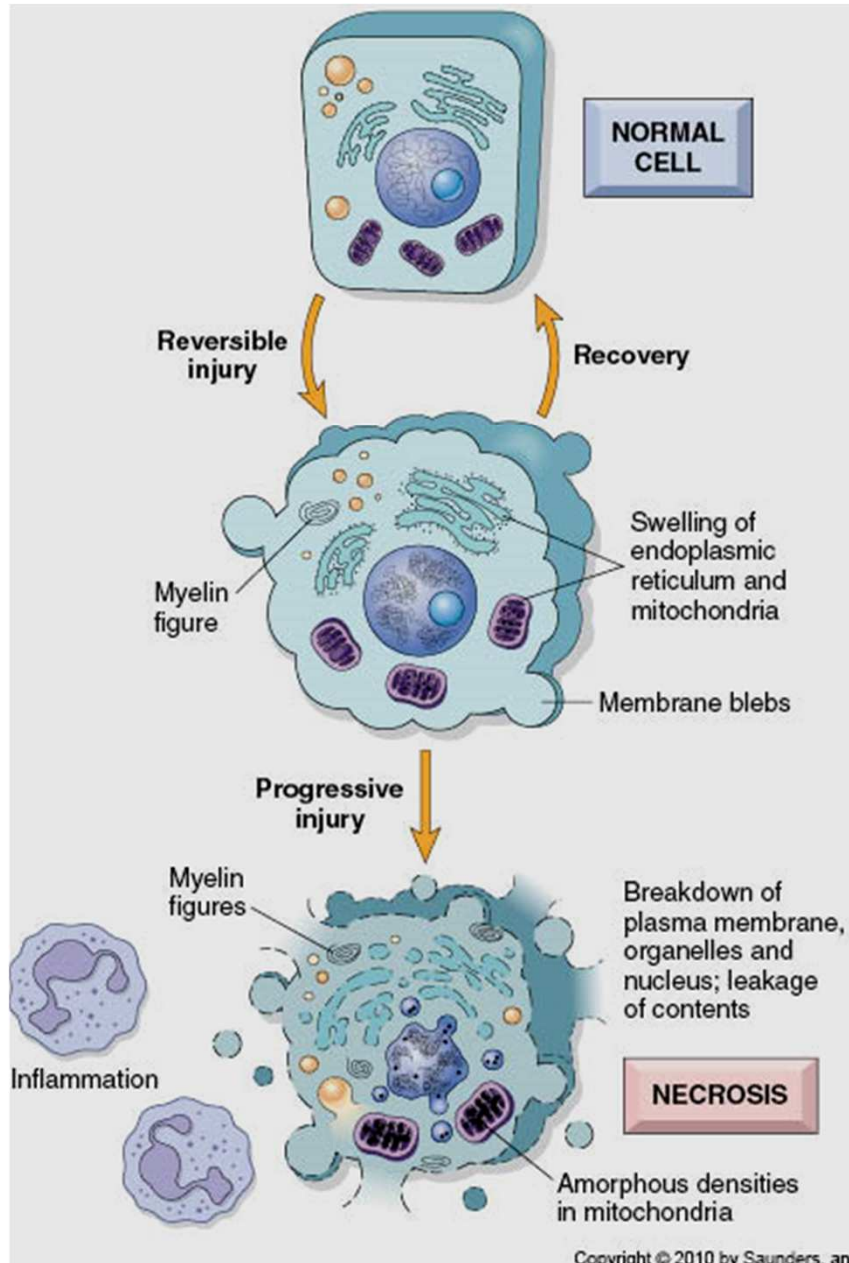

Necrosis leads to production of **D**amage **A**ssociated **M**olecular **P**atterns and to **I**nflam-**m**ation. Damage occurs to surrounding cells and tissues.

A More Physiological Cell Death

- The body is very good at maintaining a constant number of cells. So there has to exist mechanisms for ensuring other cells in the body are removed, when appropriate.
 - **Necrosis** - killing - decay and destruction NOT GOOD
 - **Apoptosis** - suicide - programmed cell death

Apoptosis is used for correct development, tissue omeostasis and elimination of «unwanted» cells

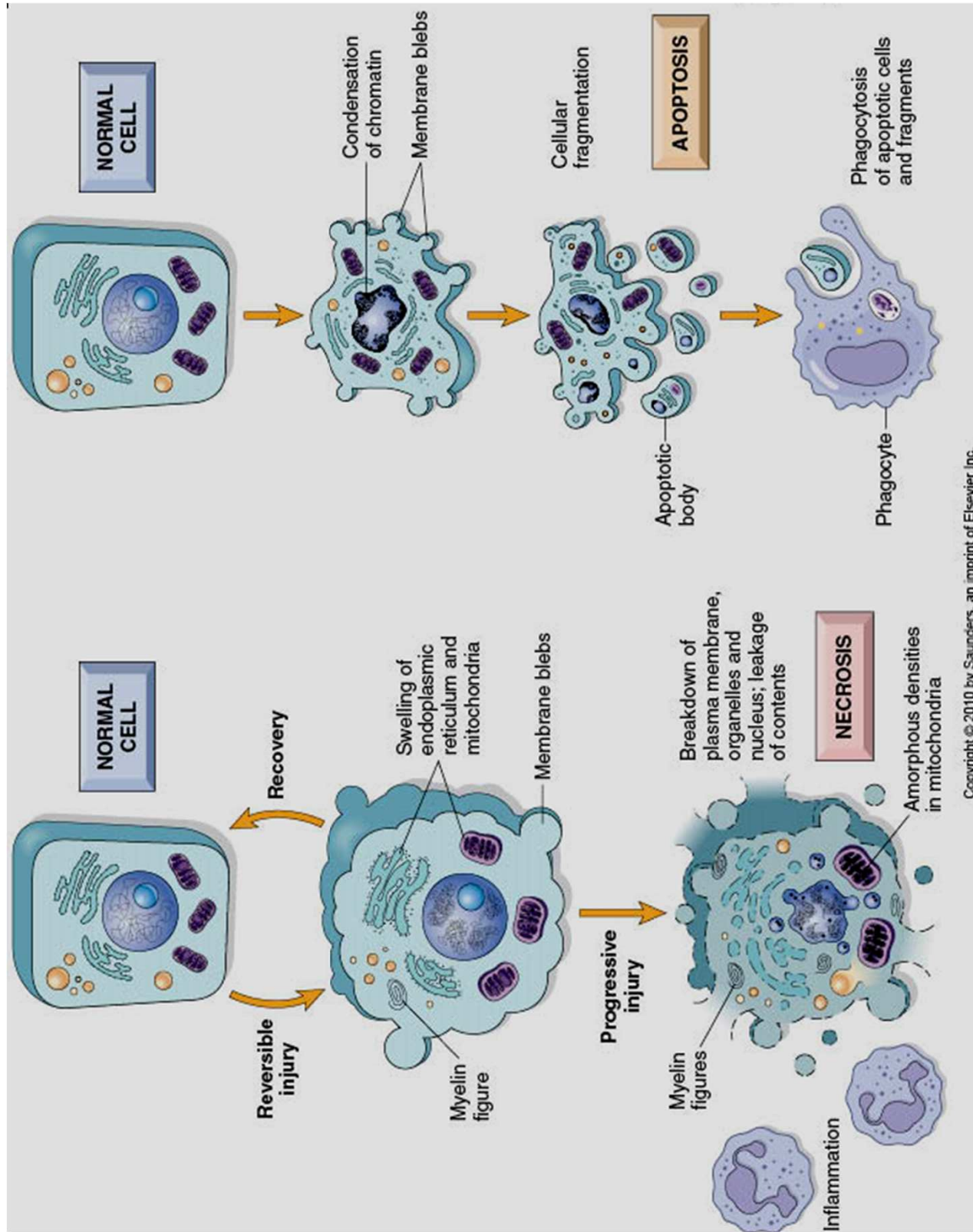

Apoptosis

- Programmed cell death
 - Especially during fetal development
 - In response to hormonal cycles (e.g. endometrium)
 - Normal turnover in proliferating tissues (e.g. intestinal epithelium)
- Cells shrink, not swell
- Nuclei condense and DNA fragments
- Cells fragment into membrane-bound bits
- Bits are phagocytosed by macrophages

Death by Injury vs. Death by Suicide (Necrosis vs. Apoptosis)

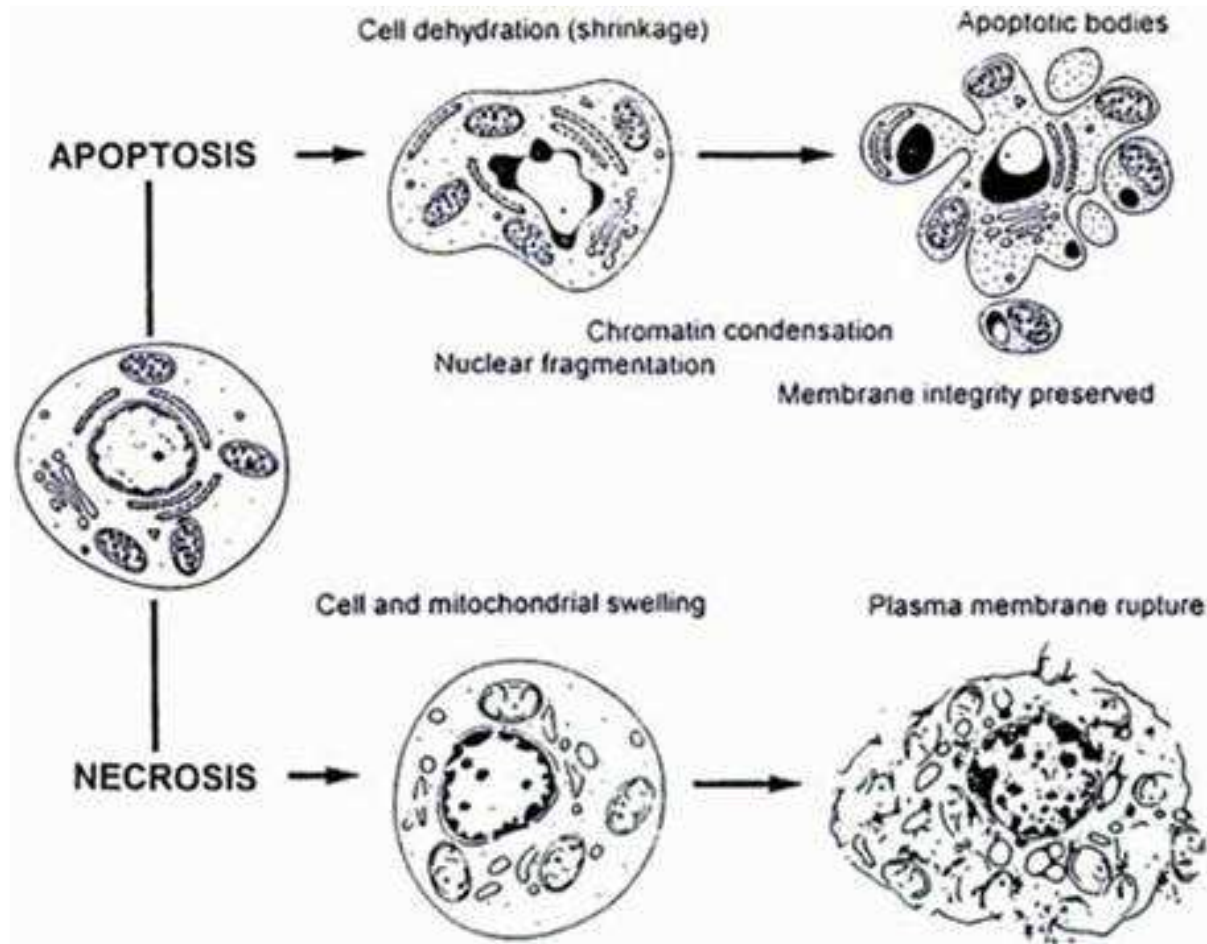

Apoptosis – Programmed Cell Death

-occurs more often than one imagines!

Why?

Developmental

Protective (destroy cells that are a threat)

infected with virus

turn off immune response

DNA damaged cells

cancer

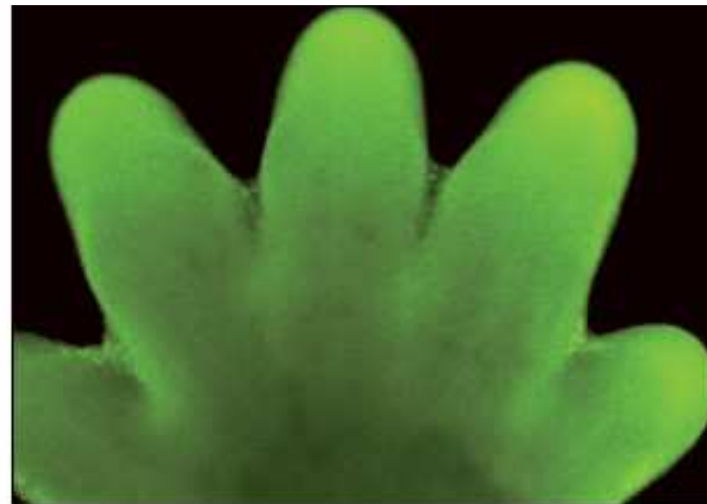
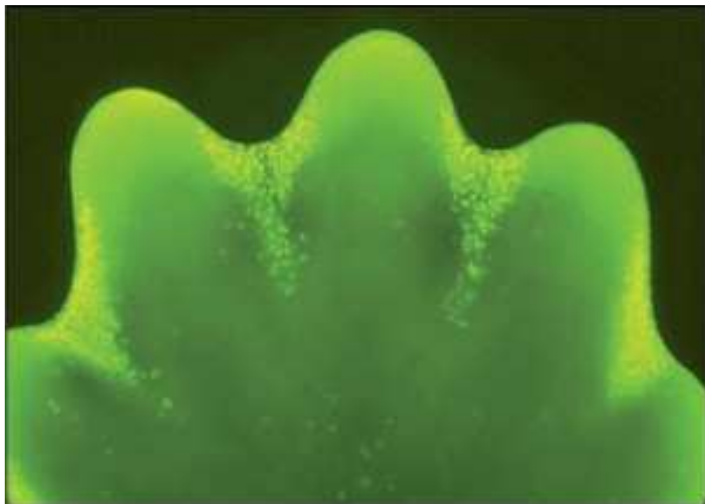

b) The tail of the tadpole is absorbed via apoptosis.

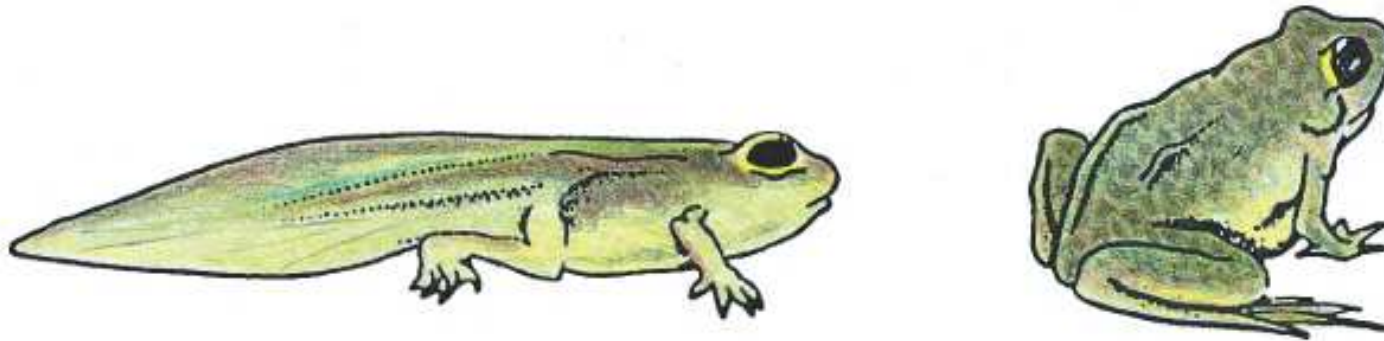

Also, in adult multicellular organisms cell death is a regular occurrence.

In humans EACH HOUR we lose many many BILLIONS of cells via apoptosis. Most of these are healthy cells which have no defects. WHY?

Fi

Development and regulation controls.

i.e. B and T cells that do not pass certain tests are removed.

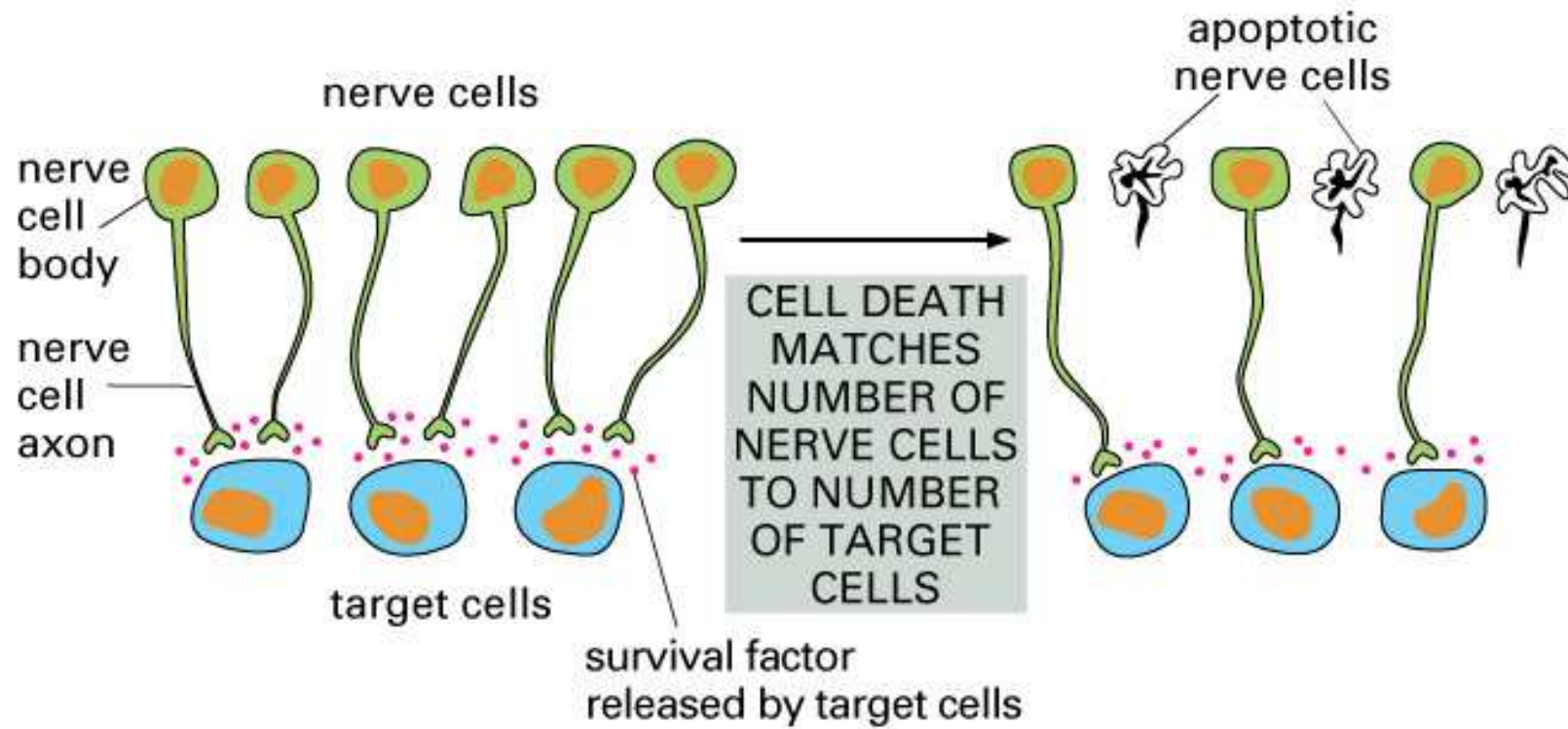
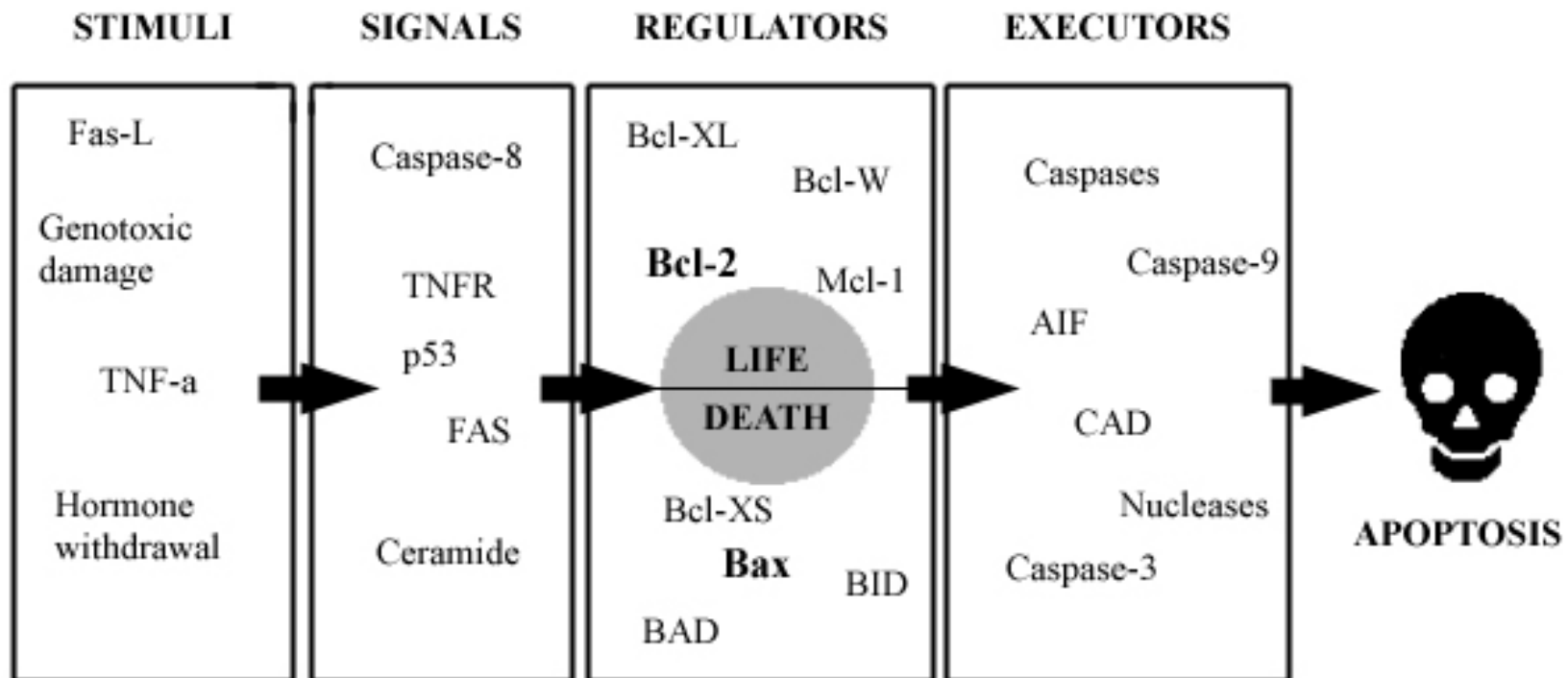

Figure 18-27 Essential Cell Biology, 2/e. (© 2004 Garland Science)

What makes a cell commit suicide?

- **withdrawal of positive signals** (growth factors, Il-2)
- receipt of **negative signals** (increased levels of oxidants, DNA damage via X-ray or UV light, chemotherapeutic drugs, accumulation of improperly folded proteins, death activators such as: TNF-a, TNF-b, Fas/FasL)



Apoptosis

Steps in apoptosis:

- the decision to **activate** the pathway;
- the actual "**suicide**" of the cell;
- **engulfment** of the cell remains by specialized immune cells called phagocytes;
- **degradation** of engulfed cell.

The actual steps in cell death require:

condensing of the cell nucleus and breaking it into pieces
condensing and fragmenting of cytoplasm into apoptotic bodies;
breaking chromosomes into fragments containing multiple number of nucleosomes (a nucleosome ladder)

Apoptosis Triggered via Two Pathways:

- **Intrinsic** or mitochondrial pathway
- **Extrinsic** or death receptor pathway

Regulation of apoptosis

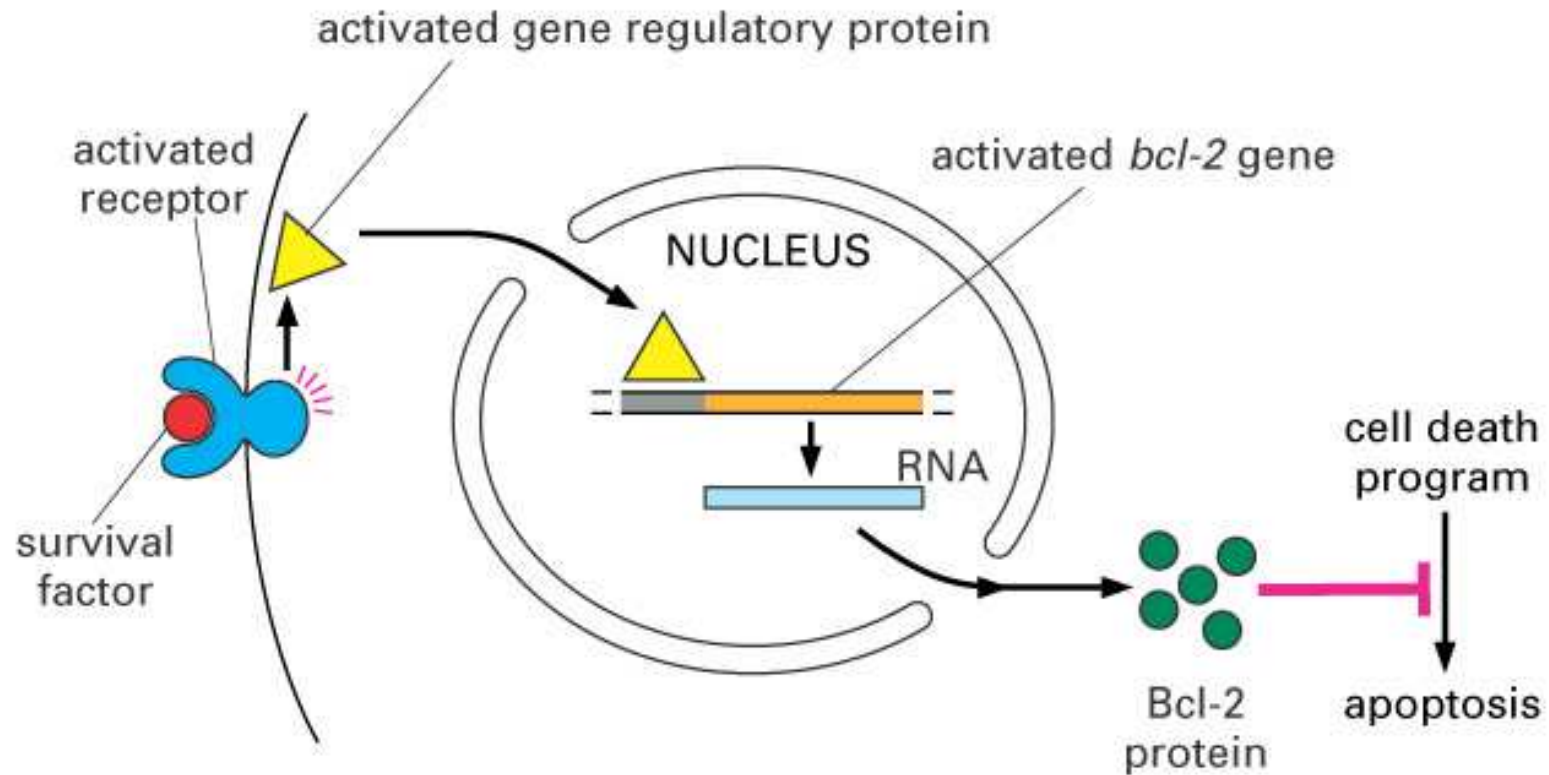

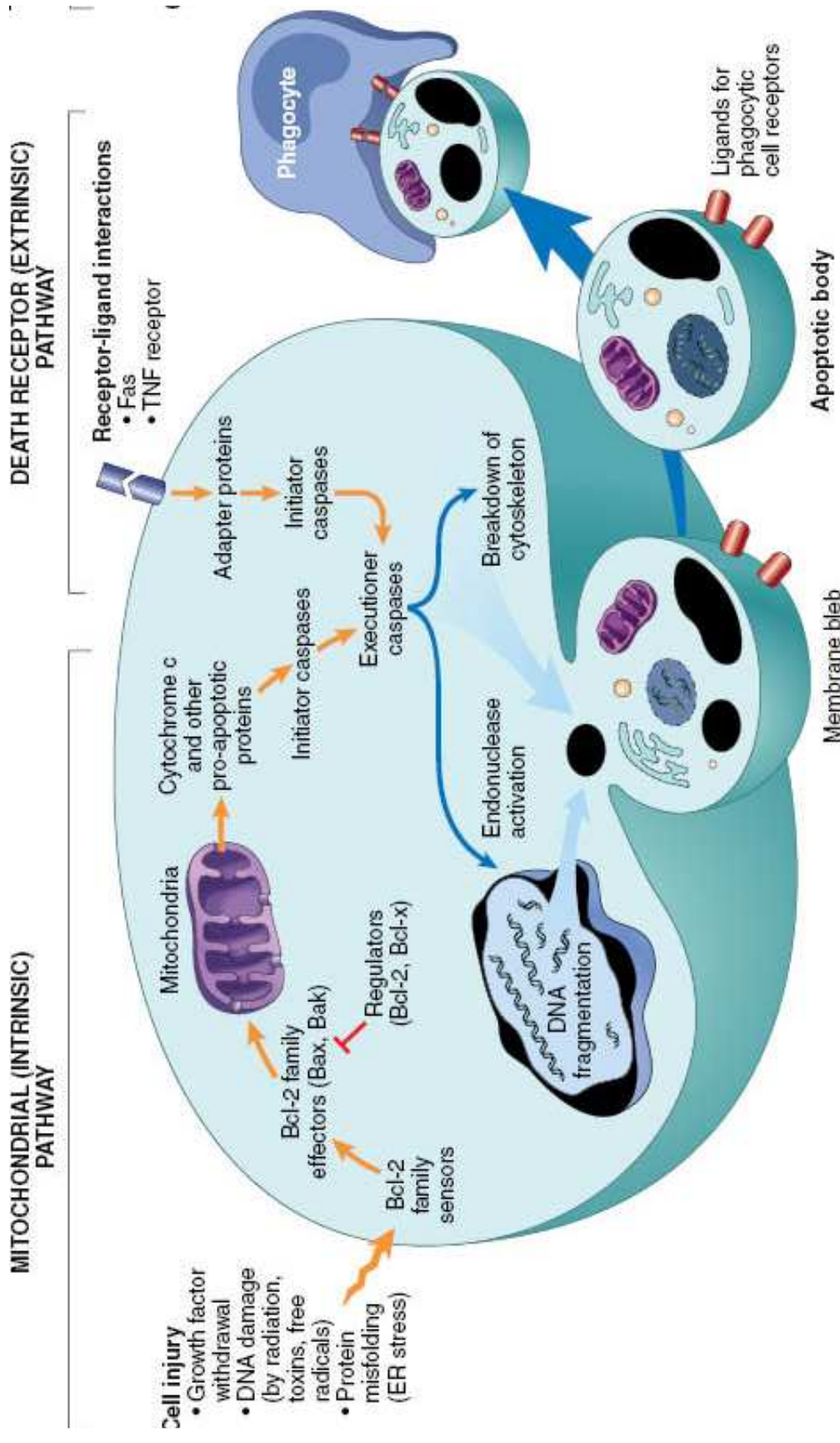

Copyright © 2010 by Saunders, an imprint of Elsevier Inc.

EXTRINSIC PATHWAY

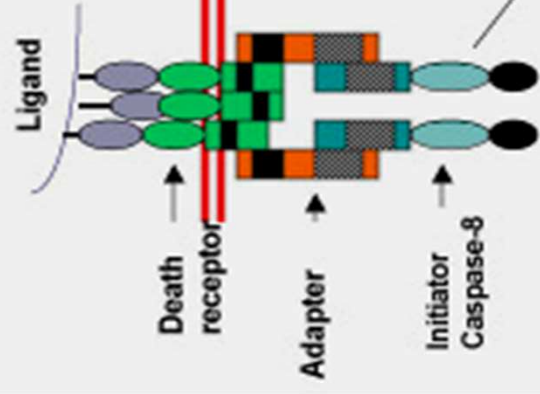

Death receptor

Adapter

Initiator Caspase-8

Effector Caspases

APOPTOSIS

INTRINSIC PATHWAY

UV, radiation, chemo, hypoxia

ER Stress (misfolded proteins)

Plasma Membrane

Initiator Caspase-12

Effector Caspases

APOPTOSIS

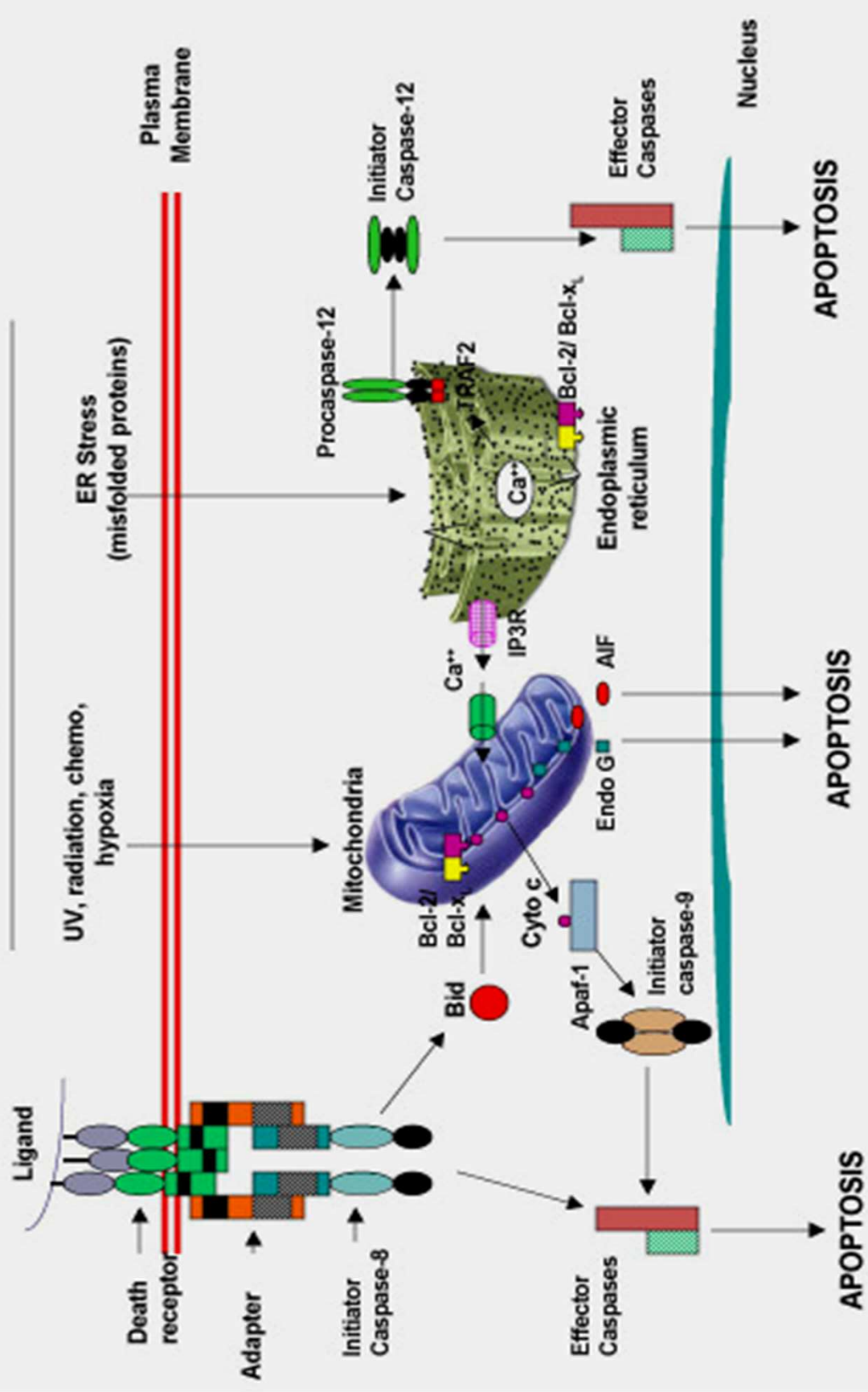

Mitochondria

Bcl-2/Bcl-x_L

Bcl-x_L

Cyto c

Bid

Apaf-1

Initiator caspase-9

Endo G

AIF

Ca²⁺

IP3R

Endoplasmic reticulum

Ca²⁺

TRAF2

Bcl-2/Bcl-x_L

Bcl-x_L

Nucleus

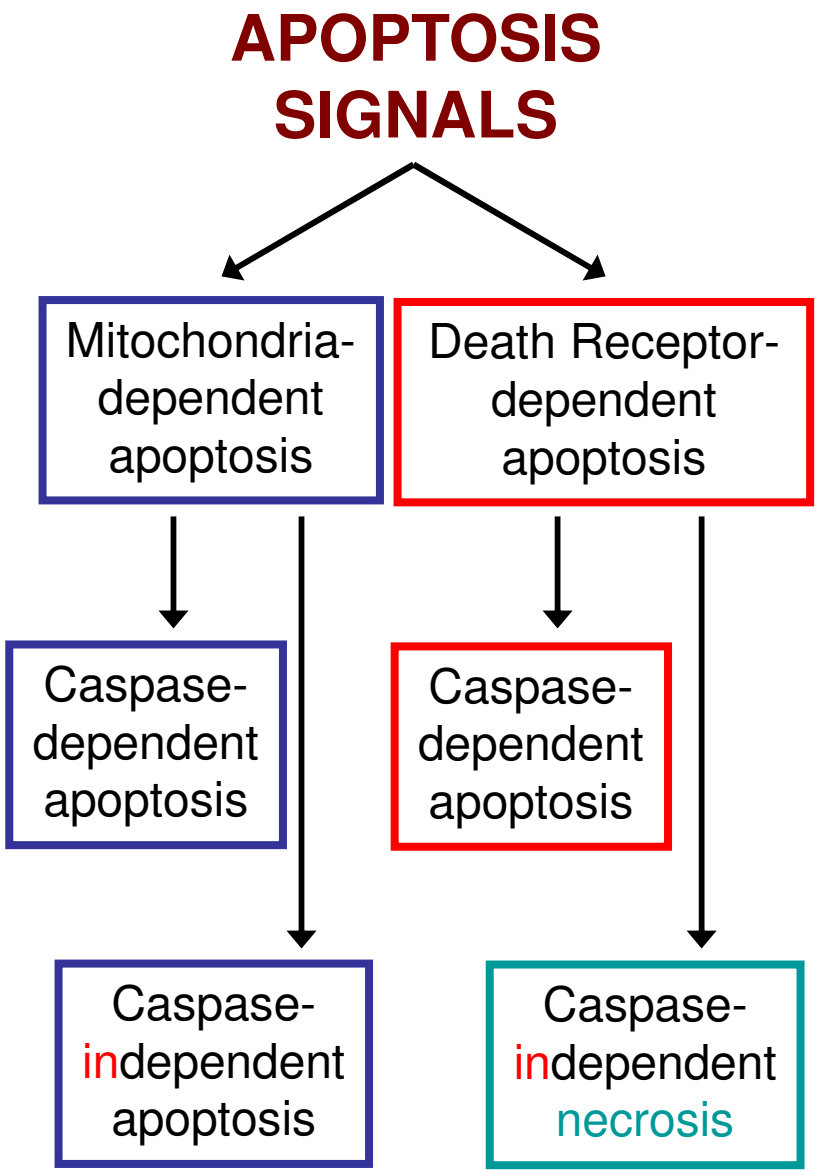
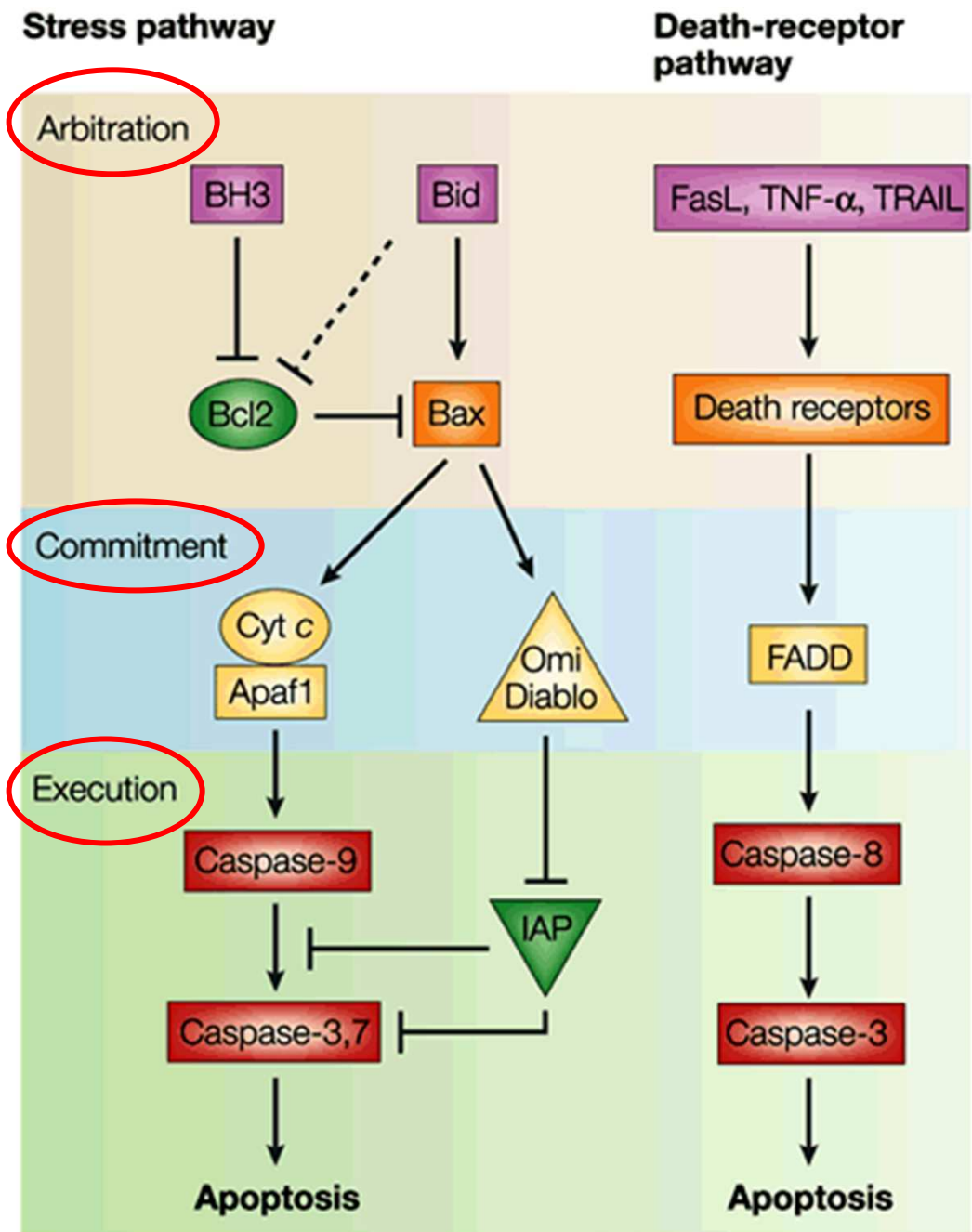

(A) ACTIVATION OF APOPTOSIS FROM OUTSIDE THE CELL (EXTRINSIC PATHWAY)

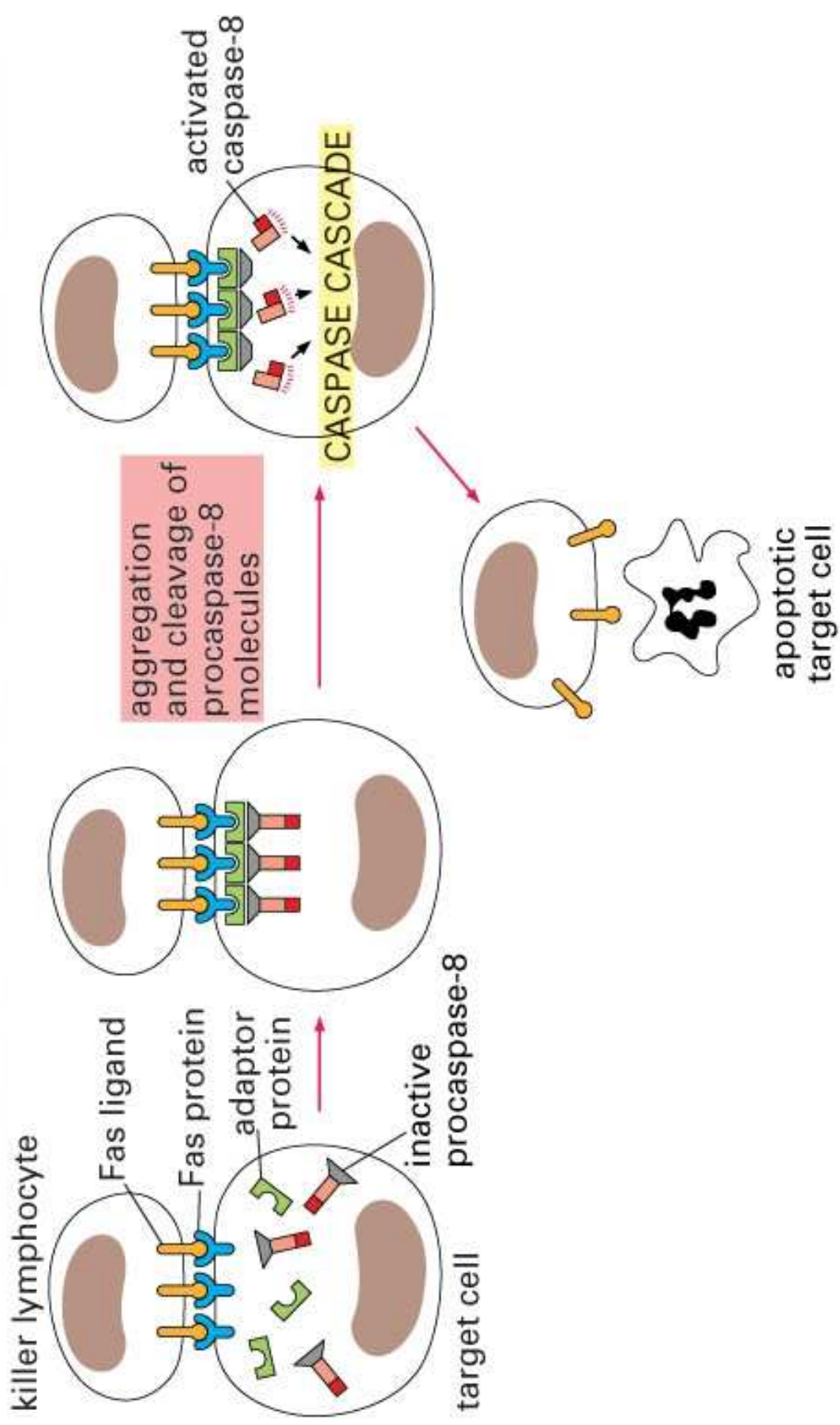
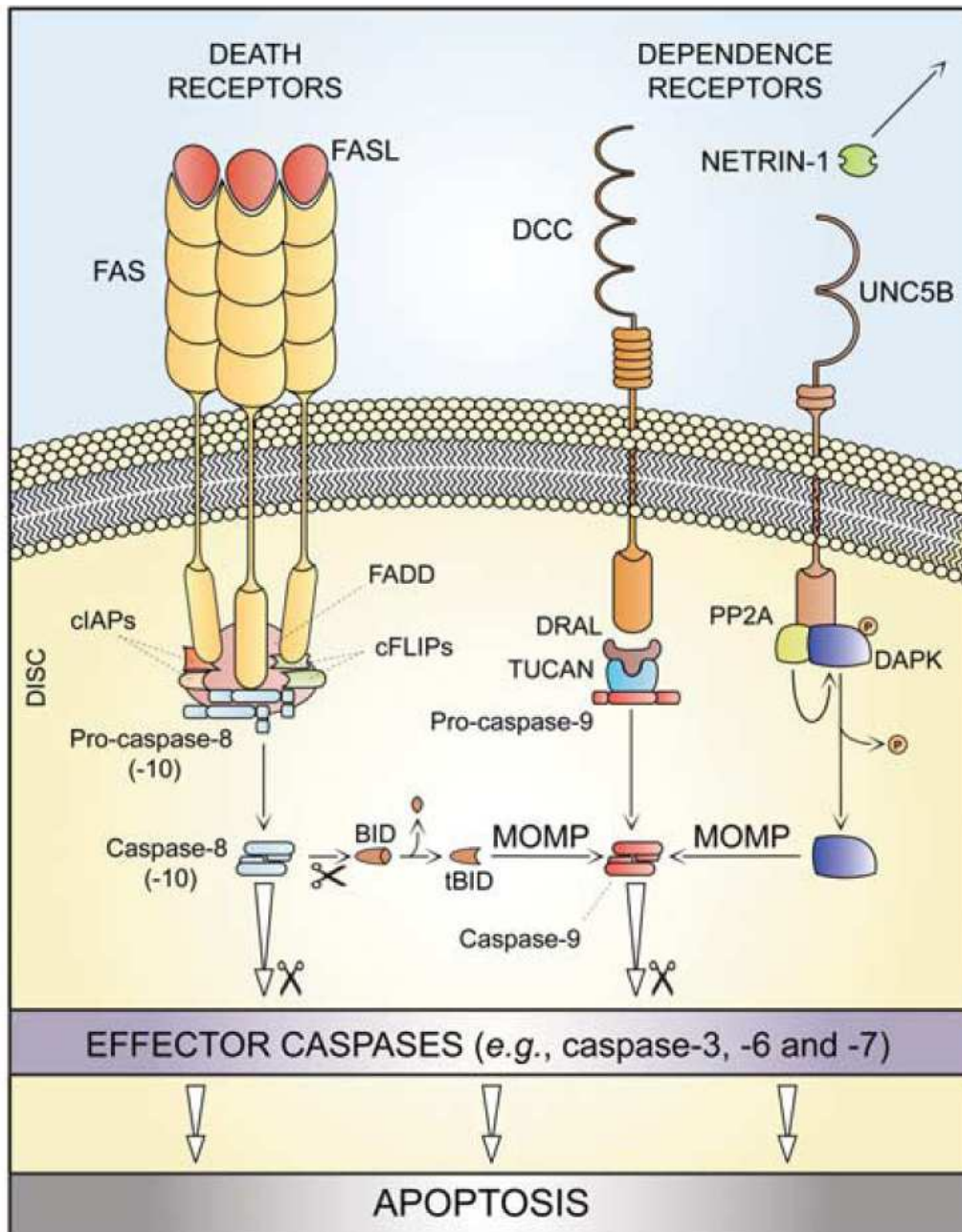

Figure 17-39 part 1 of 2. Molecular Biology of the Cell, 4th Edition.

Extrinsic Apoptosis: apoptotic cell death that is induced by extracellular stress signals that are sensed and propagated by specific transmembrane receptors



Upon FAS ligand (FASL) binding, the cytoplasmic tails of FAS (also known as CD95, a prototypic death receptor) trimers recruit (among other proteins) FAS-associated protein with a death domain (**FADD**), cellular inhibitor of apoptosis proteins (**cIAPs**), **c-FLIPs** and **pro-caspase-8** (or -10). This supramolecular platform, which has been dubbed 'death-inducing signaling complex' (**DISC**), controls the activation of caspase-8 (-10). Within the DISC, c-FLIPs and cIAPs exert pro-survival functions. However, when lethal signals prevail, caspase-8 gets activated and can directly trigger the caspase cascade by mediating the proteolytic maturation of caspase-3 (in type I cells) or stimulate mitochondrial outer membrane permeabilization (MOMP) by cleaving the BH3-only protein BID (in type II cells). Extrinsic apoptosis can also be ignited by dependence receptors like DCC or UNC5B, which relay lethal signals in the absence of their ligand (netrin-1). In the case of DCC and UNC5B, the pro-apoptotic signaling proceeds through the assembly of a DRAL- and TUCAN- (or NLRP1-) containing caspase-9-activating platform or by the dephosphorylation-mediated activation of death-associated protein kinase 1 (DAPK1) by UNC5B-bound protein phosphatase 2A (PP2A), respectively. DAPK1 can mediate the direct activation of executioner caspases or favor MOMP. tBID, truncated BID

DEATH RECEPTORS:

Pathways linking external signal receptors to caspase-8

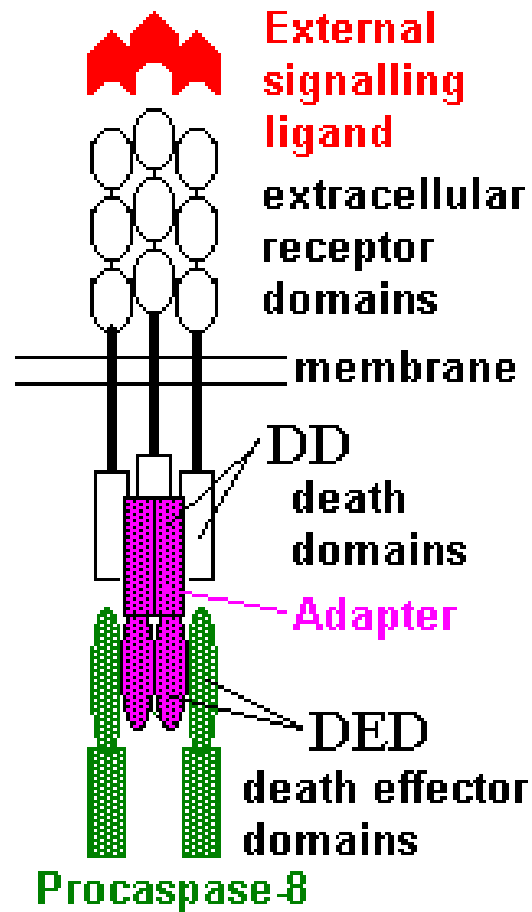

A variety of cell surface receptors related to **TNF-R** (tumor necrosis factor receptor) interact with the apoptotic activation system. The intracellular portion of the receptor carries a specific protein interaction domain called the **death domain, DD**. The DD is activated by proximity, brought about when bound extracellular ligand induces receptor oligomerization. Activation can also be induced in absence of ligand by artificial cross-linking of the receptor.

Clustered receptor DDs recruit a variety of DD-containing adapters, of which **FADD**, **Fas-associated death domain protein** (also known as MORT1) bridges to a second protein interaction domain, **DED**, or **death effector domain**. The cluster of FADD-DEDs recruits procaspase-8, which also carries DEDs at its N-terminus (corresponding to the CARDs on Procaspase-9).

Procaspase-8 is activated to Caspase-8 by proximity-induced self-cleavage. Procaspase-10 is the only other caspase with DED boxes, and may substitute for Caspase-8 in some cases.

In some cells, TNF receptors associate with adapters linked to cell proliferation or inflammatory signaling pathways, and may induce **anti-apoptotic** c-IAPs.

Extrinsic or Death Receptor Pathway

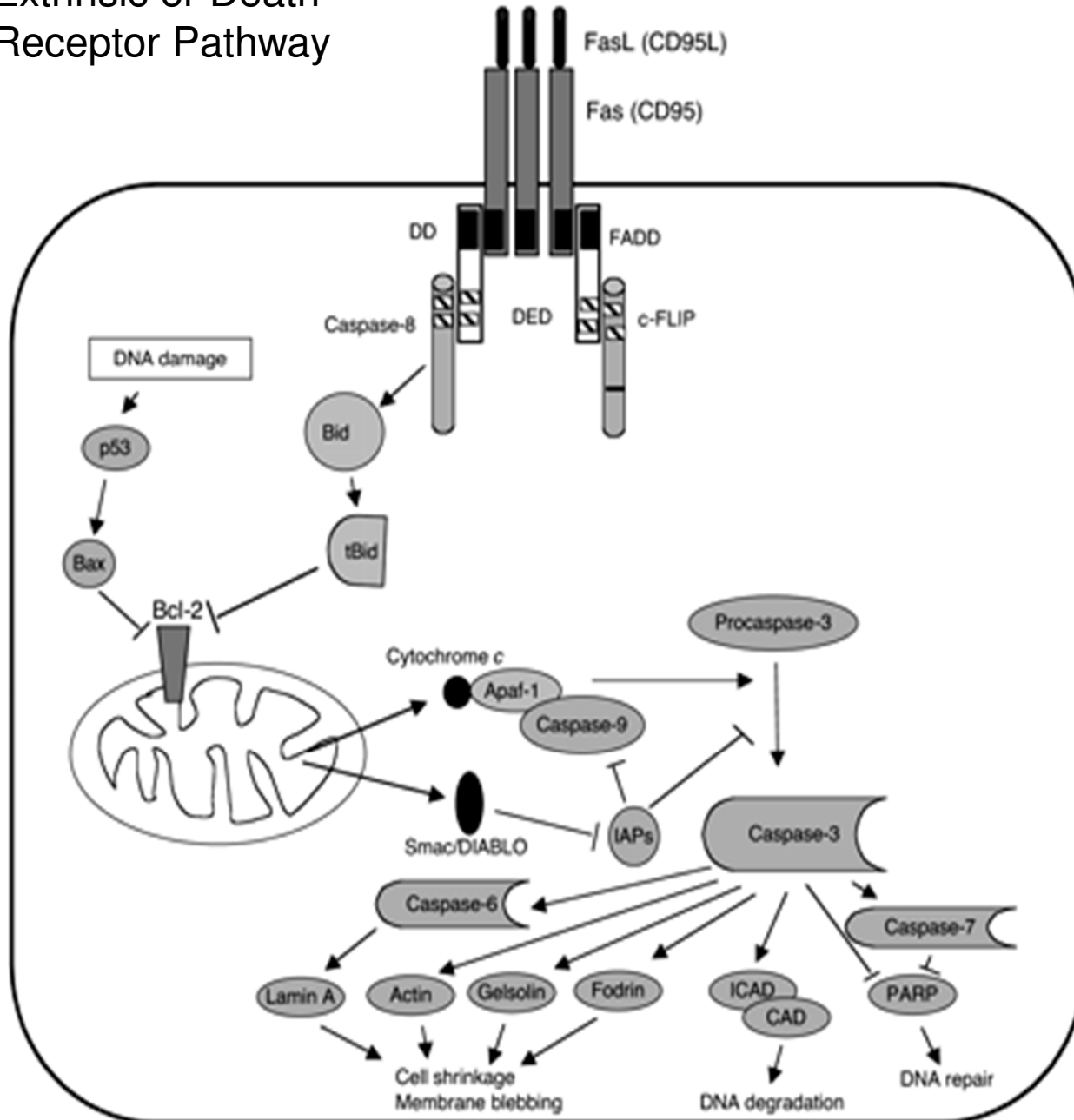

- Binding of Fas by FasL induces recruitment of FADD to the cytoplasmic tail of Fas
- The opposite end of FADD contains a death effector domain (hatched boxes); recruitment of either procaspase-8 or c-FLIP
- Caspase-8 can cleave Bid
- truncated Bid (tBid) can inactivate Bcl-2 in the mitochondrial membrane.
- This allows the escape of cytochrome c, which clusters with Apaf-1 and caspase-9 in the presence of dATP to activate caspase-9.
- Smac/DIABLO is also released from the mitochondria and inactivates inhibitors of apoptosis (IAPs).
- breakdown of several cytoskeletal proteins and degradation of the inhibitor of caspase-activated DNase (ICAD).

Caspases

- Proteins which degrade other proteins are employed by apoptosis - **caspases**

- Made as inactive precursors - **procaspases**

- These are activated by other proteins when the right signal is received

- One caspase cleaves the lamin proteins resulting in the irreversible breakdown of the nuclear membrane.

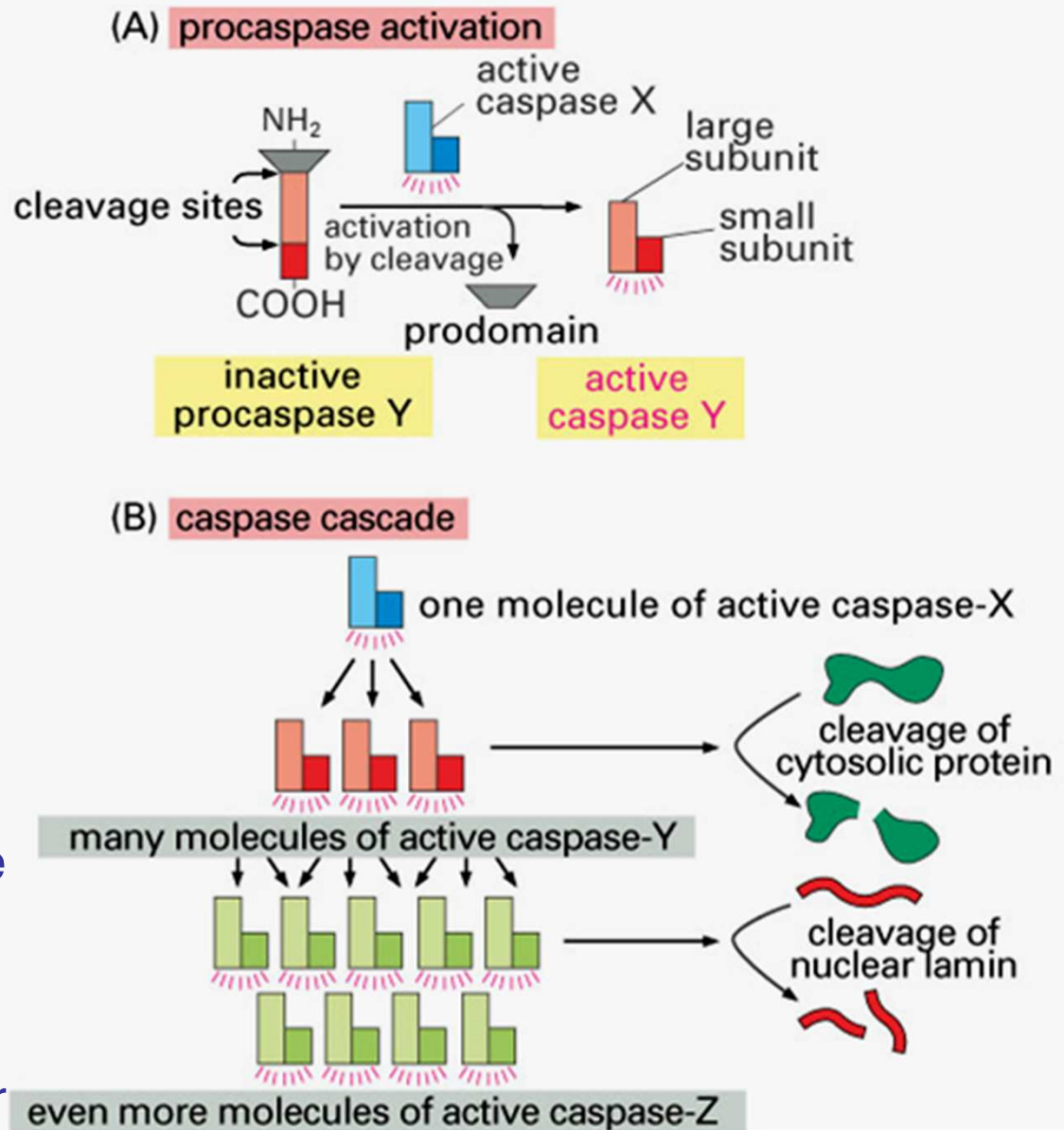

Caspases

- Caspases were implicated in apoptosis with the discovery that CED-3 is related to caspase 1 (interleukin-1 β -converting enzyme).
- They are expressed as proenzymes (30-50 kD) that contain three domains: N-terminal, large domain (L), and small domain (S). Proteolytical activation remove N-terminal, then the association of L and S to form a heterodimer active enzyme.
- Caspases recognize four amino acid N-terminal to the cleavage site-aspartic acid with high substrate specificity.

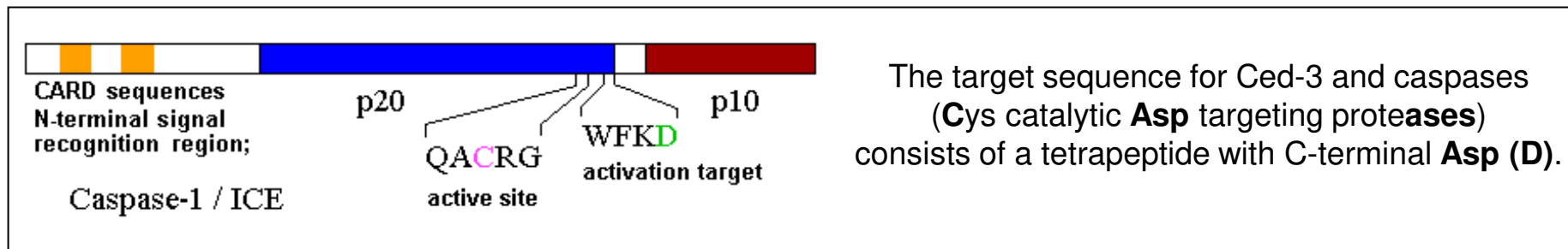
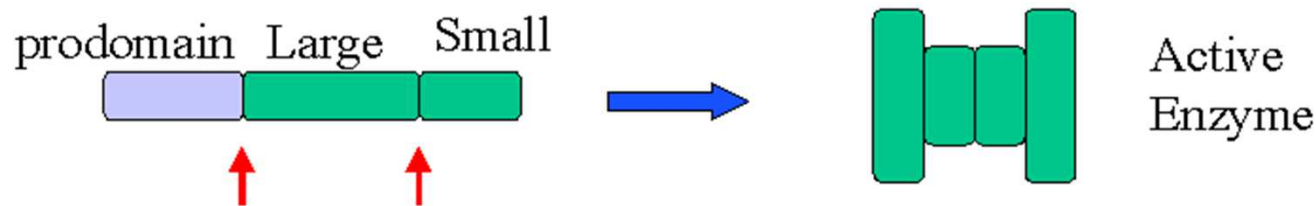

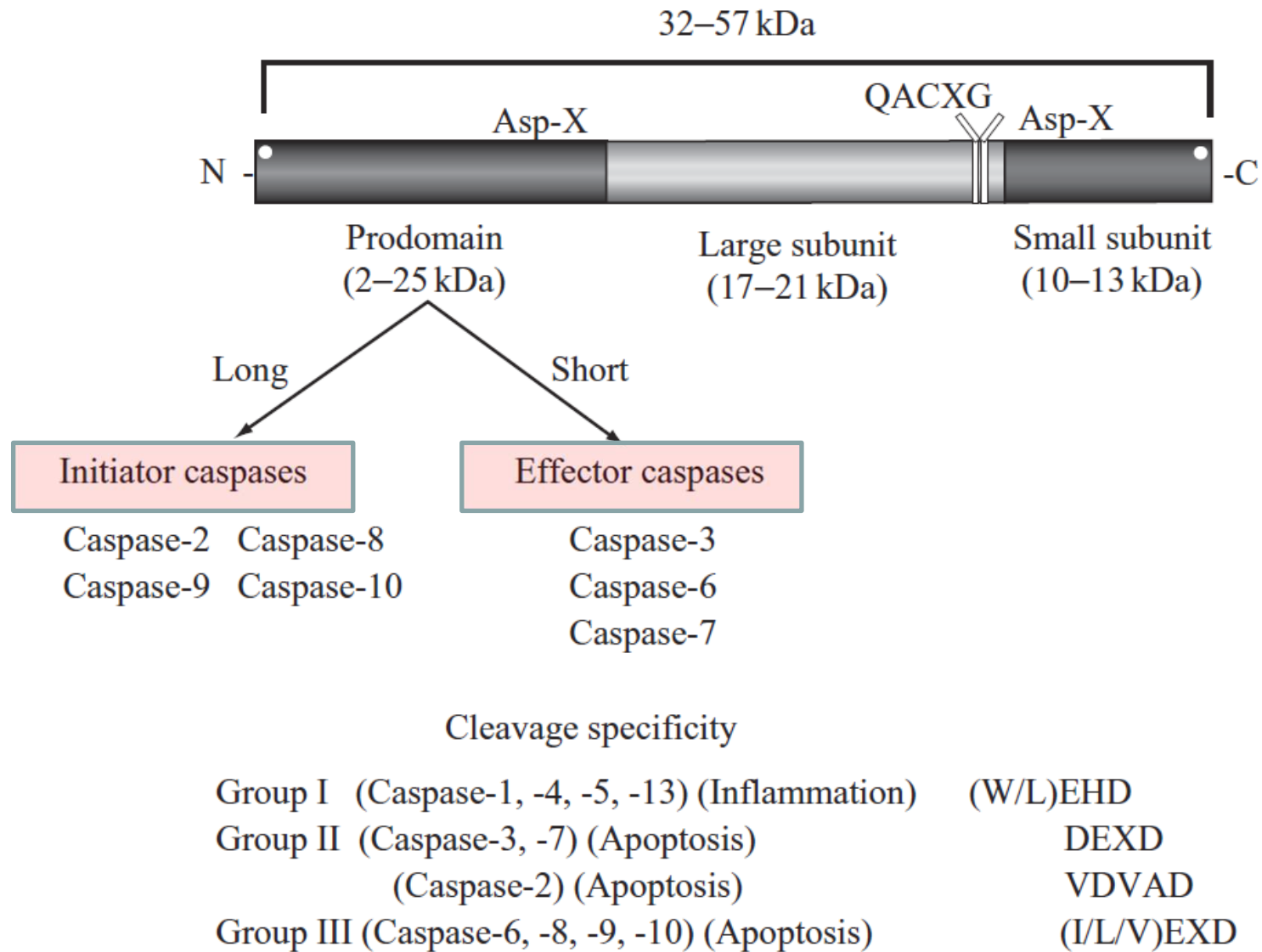
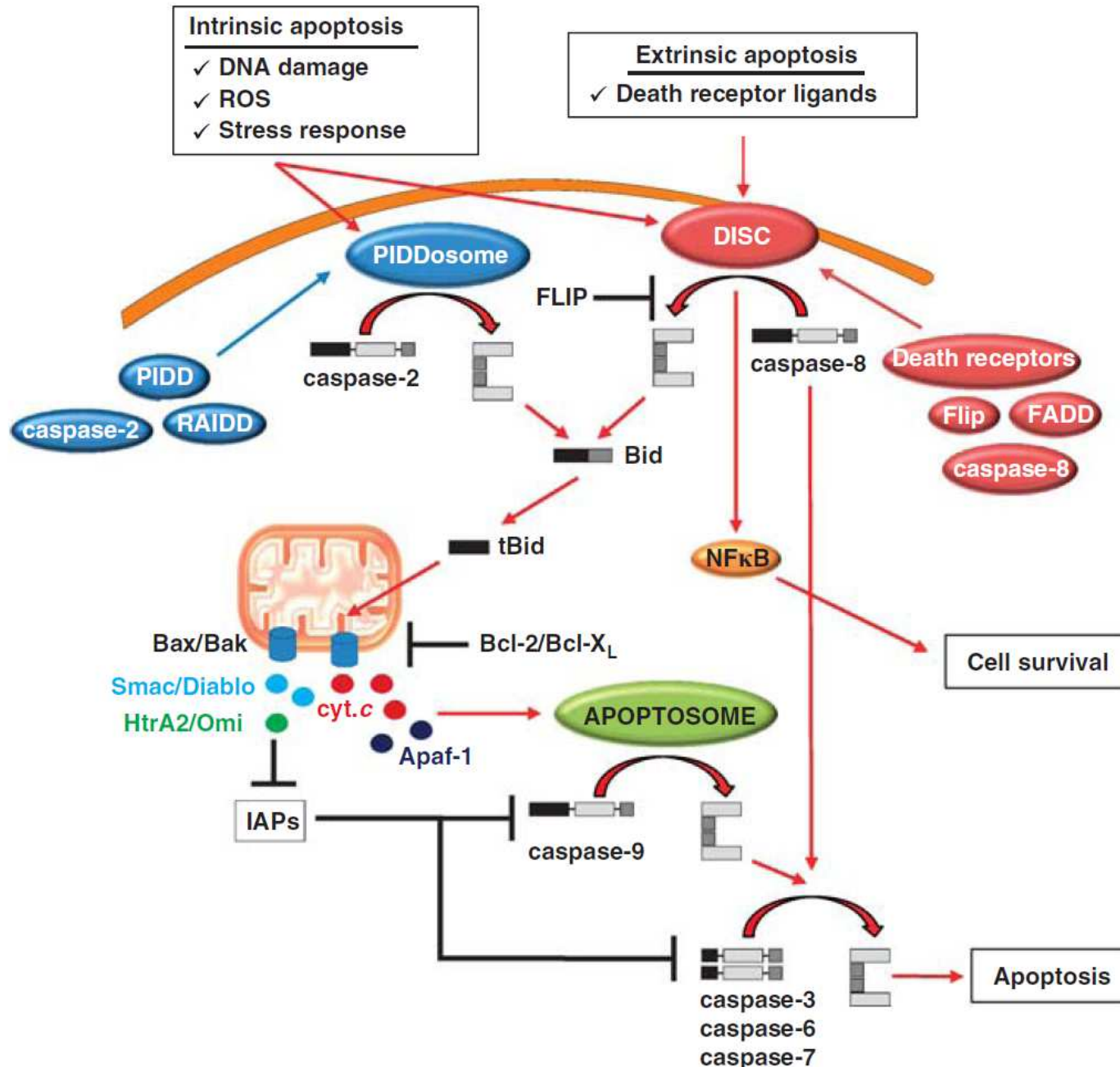

Figure 8.2 The structural and functional organization of caspases.

Caspase cascades and their inhibitors



Formation of multicomponent complexes triggers initiator caspase dimerization sufficient for their activation:

- DISC: Death-inducing signaling complex
- Apoptosome
- (PIDD)osome: p53-induced protein with a death domain

In vivo substrates of effector caspases

Nuclear	Lamins, nucleoplasmin, the SR protein 70K U1, hnRNP C, RNA Pol I upstream binding factor, the p53 regulator MDM2, pRB, p27 ^{Kip} and p21 ^{Cip}
DNA related	MCM3, Repair enzymes including Rad51, poly-ADP-ribose polymerase (PARP), topoisomerase, inhibitor of caspase activated DNase, (iCAD/DFF45)
Cytoskeleton	actin, gelsolin, spectrin, keratin
Cytoplasmic	β -catenin, Bcl-2
Protein kinases	DNA dependent protein kinase, protein kinase C, CAM kinase, focal adhesion kinase, MAP and ERK kinases, Raf1, Akt1/protein kinase B, ROCK I.

Apoptosis—mitochondrial activation

- Initiated by cellular damage or viral infection
- Mitochondrial membrane permeability regulated by Bcl-2, Bcl-x, Mcl-1
- Activated by BH3-only proteins which create Bax/Bak channels
- Cytochrome C released to cytosol
- CytC binds Apaf-1 and activates caspase-9
- Caspases (cysteine proteases that cleave after aspartate residues) activate a cascade of lytic enzymes
- Cellular and nucleosomal fragmentation occurs
- Dead cell fragments removed by phagocytes

(B) ACTIVATION OF APOPTOSIS FROM INSIDE THE CELL (INTRINSIC PATHWAY)

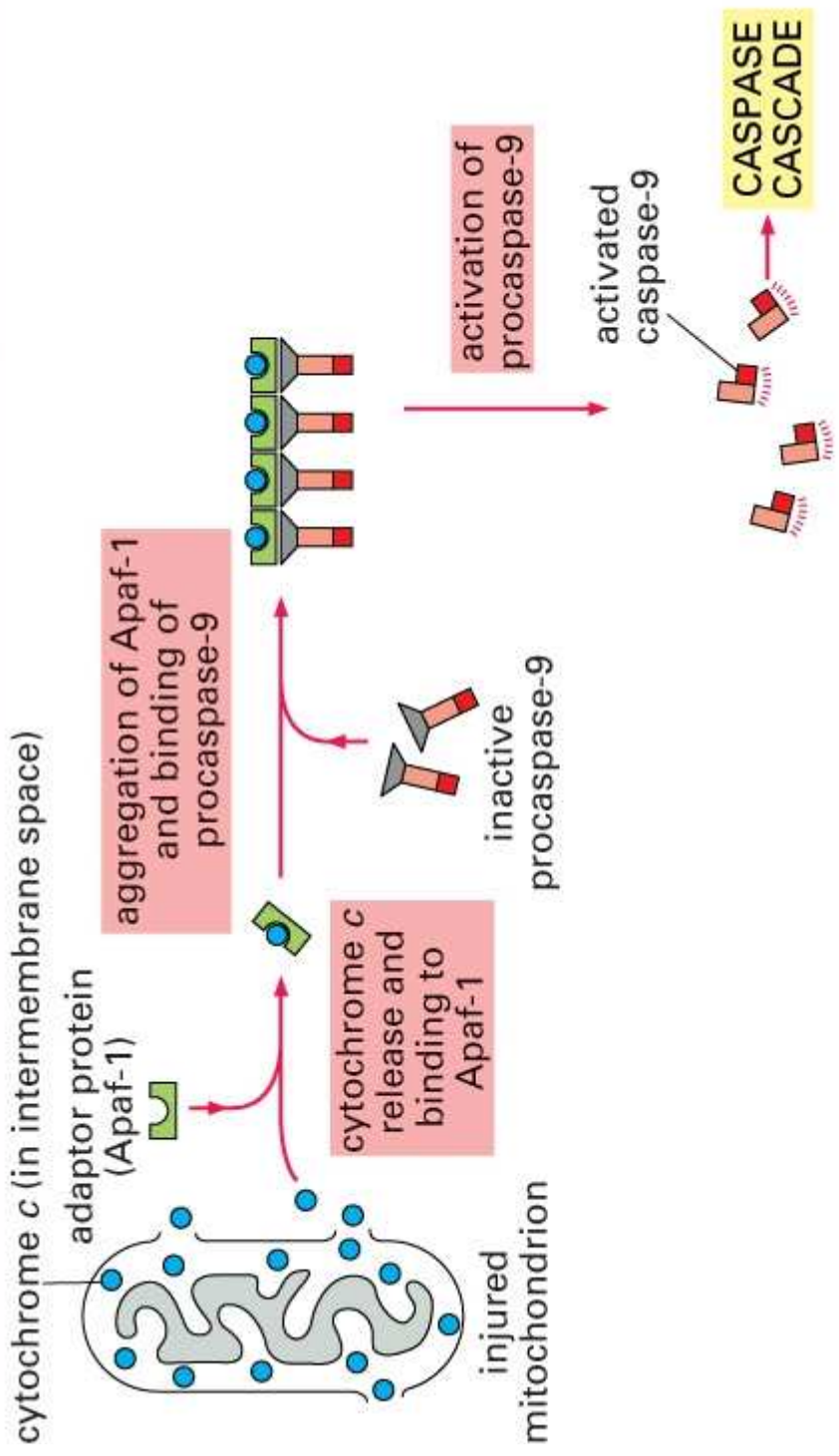

Figure 17-39 part 2 of 2. Molecular Biology of the Cell, 4th Edition.

Mitochondria play a central role in mediating the apoptotic signal

Mitochondria-free cytoplasm would not induce apoptosis *in vitro*

Cytochrome c-neutralizing antibodies block apoptosis

Cytochrome **c** is an abundant protein of the mitochondrial inner membrane, and acts as an electron transport intermediate.

a and **b** type cytochromes are inaccessible components of large complexes, but cytochrome **c** is monomeric, freely diffusible in the inner membrane, and in equilibrium between inner membrane, inter-membrane space and cristae.

The events of apoptotic activation lead to alterations in permeability of the mitochondrial membrane pore proteins and release of cytochrome **c**.

Initial release of cytochrome **c** occurs by a highly specific process, **involving proteins of the Bcl-2 family**

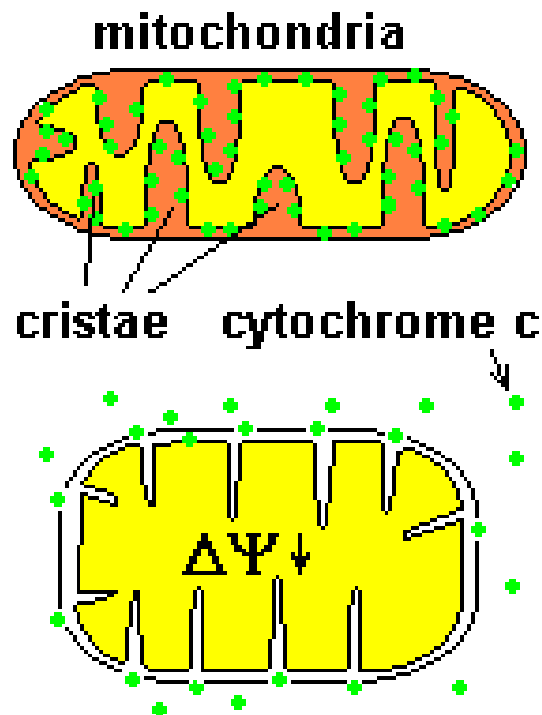

Signaling leading to activation of mitochondria-related apoptosis

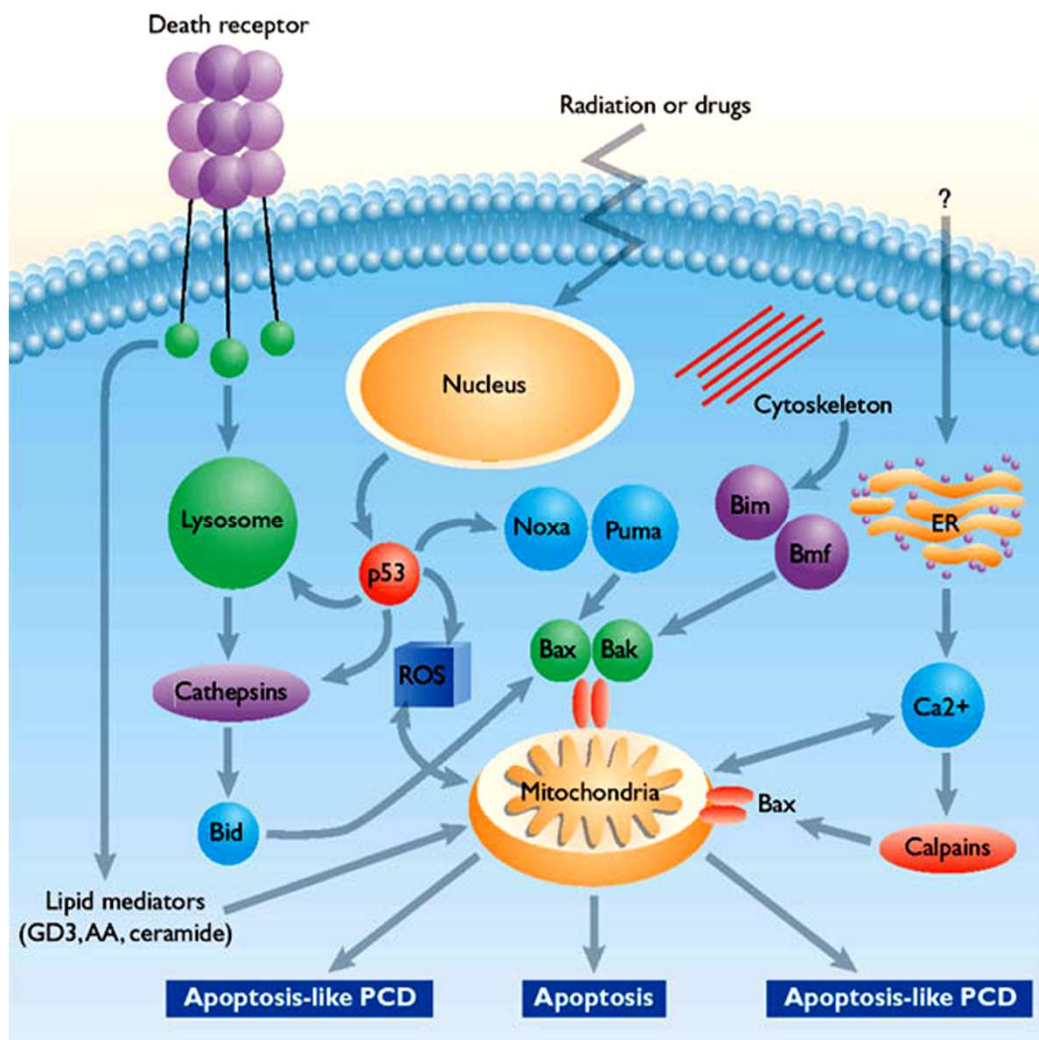

Death receptors of the TNFR family, as well as various oxidants, detergents and chemotherapeutic drugs, induce the release of active cathepsins from the lysosomal compartment. These cathepsins cleave Bid, which can then mediate cathepsin-induced MPT. Disruption of the cytoskeleton leads to the release of the BH3 domain-only proteins Bim and Bmf. DNA damage induced by radiation or various chemotherapeutic drugs induces the p53-mediated transcription of genes encoding Bax, BH3 domain-only proteins (Noxa or Puma), proteins involved in ROS generation and cathepsin D. ER stress results in the release of calcium, which may cause direct mitochondrial damage or activate Bax through calpain-mediated cleavage. Various death stimuli, mediated through death receptors, trigger the production of lipid second messengers (such as ganglioside (GD3), arachidonic acid (AA) and ceramide) that are involved in MPT and mitochondrial damage. Depending on the stimulus and the type of cell, as well as the metabolic status of the cell, MPT leads to either caspase-mediated apoptosis or caspase-independent PCD.

Bcl-2 family: Pro-Life and Pro-Death factions

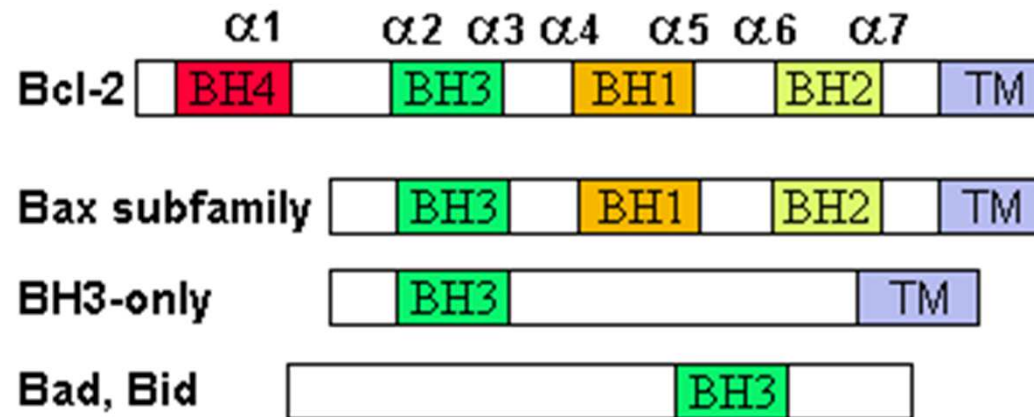

Bcl-2 and its closest relatives **Bcl-X_L**, **Bcl-w** and **Ced-9** are α -helical proteins having all four BH domains and are **pro-survival**. They suppress cytochrome c release, and are oncogenic when overexpressed. However, Bcl-X_S, a splice variant of Bcl-X_L having BH4 but lacking BH1 and BH2 is pro-apoptotic.

Bax and **Bak** lack the BH4 domain, and are **pro-apoptotic**. Bax expression is stimulated by p53, a mechanism for pro-apoptotic action of p53. Ectopic or overexpression of Bax induces cytochrome c release and apoptosis, and addition of Bax to mitochondria *in vitro* induces cytochrome c release.

The **BH3-only** sub group are **strongly pro-apoptotic**, and include **Bim**, **Bik** and **Egl-1**, which only have the 18-residue BH3 and the transmembrane region, while **Bad** and **Bid** only have BH3. The helical BH3 element allows for homo- and heterodimerization between family members. The non-homologous regions of BH3-only proteins could provide links to apoptotic signaling systems.

Bcl-2 family: Pro-Life and Pro-Death factions

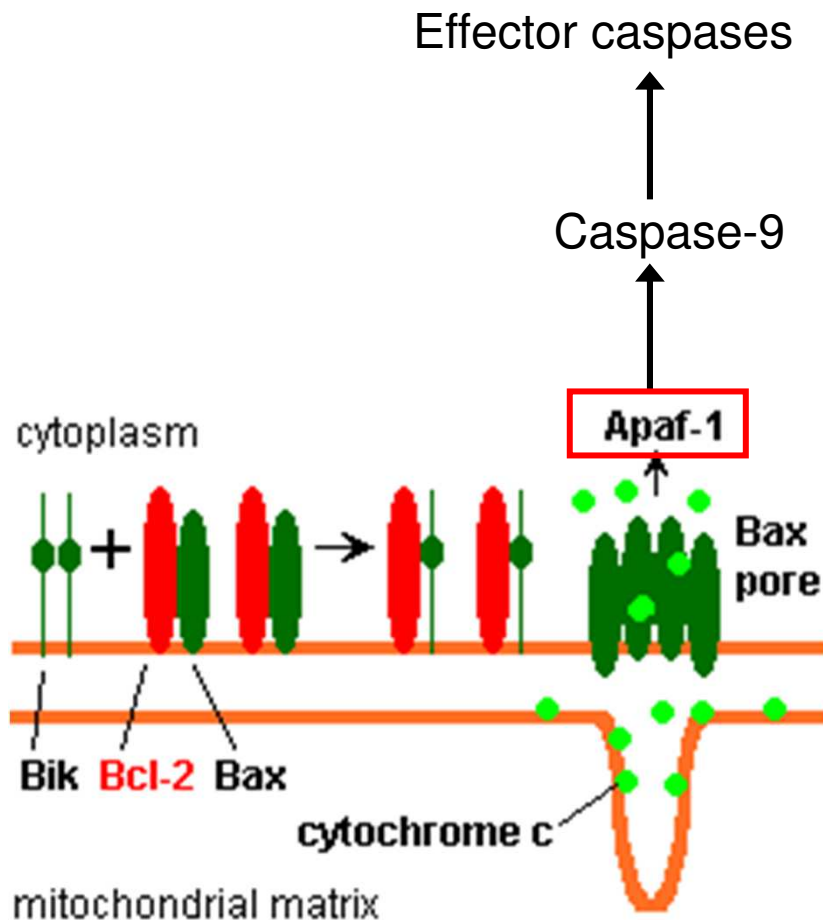

Vertebrate **Apaf-1** activation occurs through cytochrome c binding. Bcl-2 and Bcl-X_L appear to act by dimerizing with pro-apoptotic agonists such as Bax or Bak.

Normally, the balance is in favor of Bcl-2 or Bcl-X_L, but the BH3-only factors appear to act to titrate out the Bcl2/Bcl-X_L, tipping the balance in favor of Bax/Bak.

Bax can oligomerize in the membrane to **form a permeability channel able to transport cytochrome c**.

BH3-only factors have been reported to induce reorganization of the cristae. Alternative models suggest that Bid/Bad/Bak-like factors act to open permeability channels such as the **permeability transition pore**, by disrupting the membrane potential, and affecting the voltage-dependent anion channel VDAC and ATP/ADP exchange transporter.

Apoptosis results in a quick and clean cell death, without damaging its neighbours, or eliciting an immune response. Every cell is equipped with the 'cell death pathway'. Apoptosis is an intracellular proteolytic pathway. The DNA is broken into small 200 bp units.

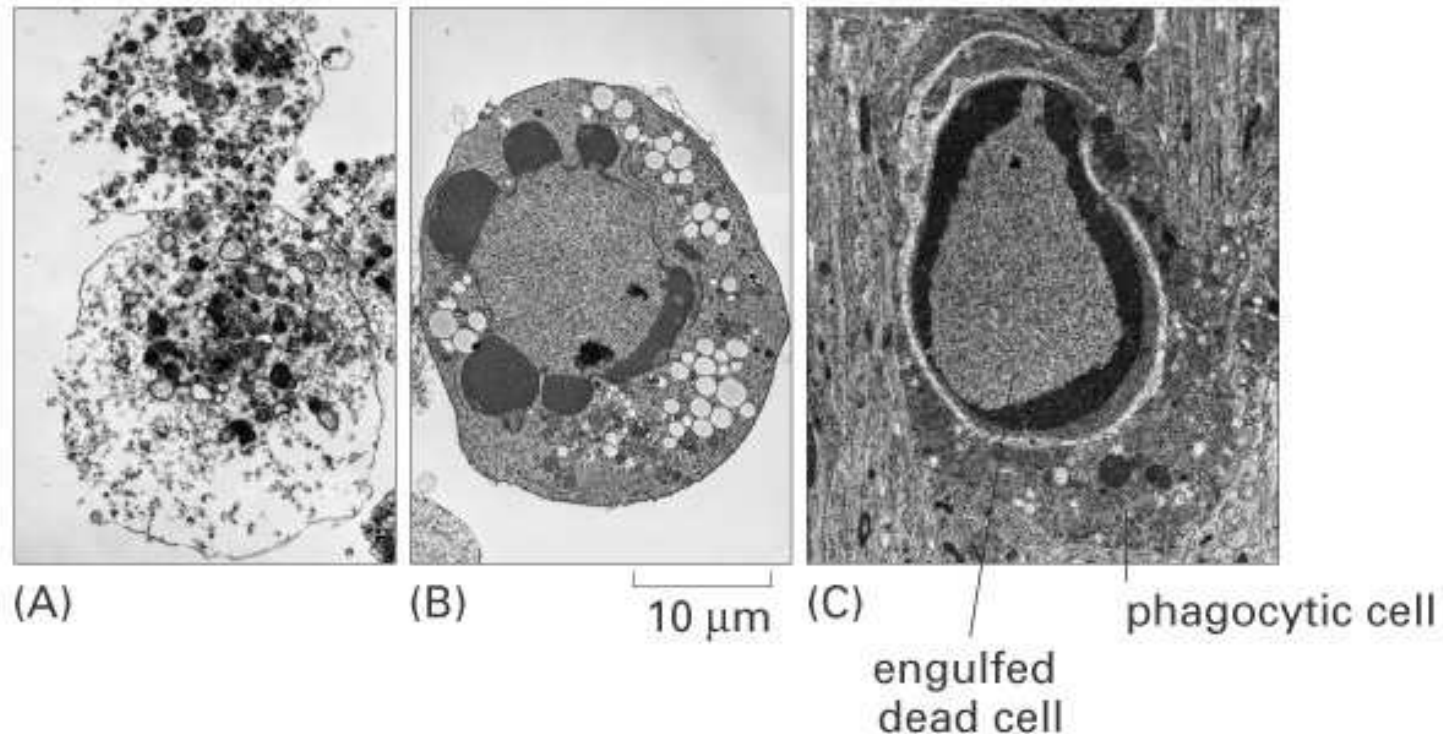

The cytoplasm shrinks. The mitochondria release cytochrome c. The outer surface of the plasma membrane gets coated with a different sugar - one that macrophages can sense and phagocytose.

Morphology of Apoptosis

Morphological changes that occur during apoptosis.

First, (a) the normal cell (b) shrinks and the condensed chromatin collapses into crescents around the nuclear envelope

(c) the membrane begins to bulge and bleb (d) the blebbing increases and the cell finally breaks into a number of apoptotic bodies (e) which lyse *in vitro* (f) and are phagocytosed *in vivo*.

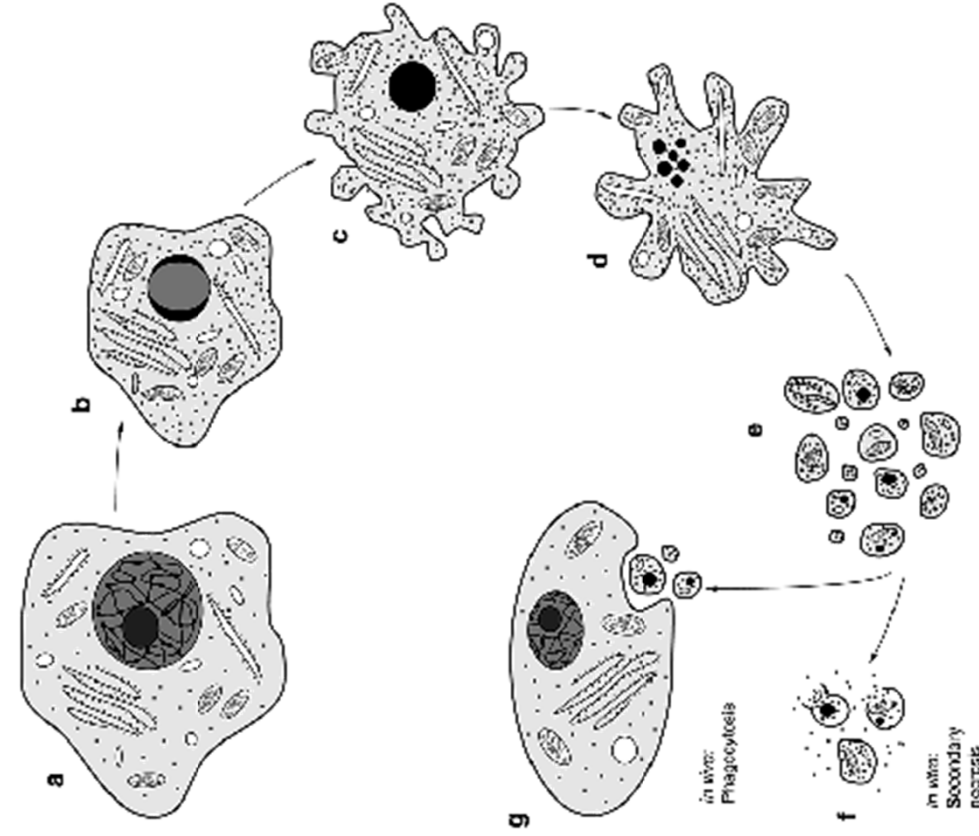

Apoptotic liver

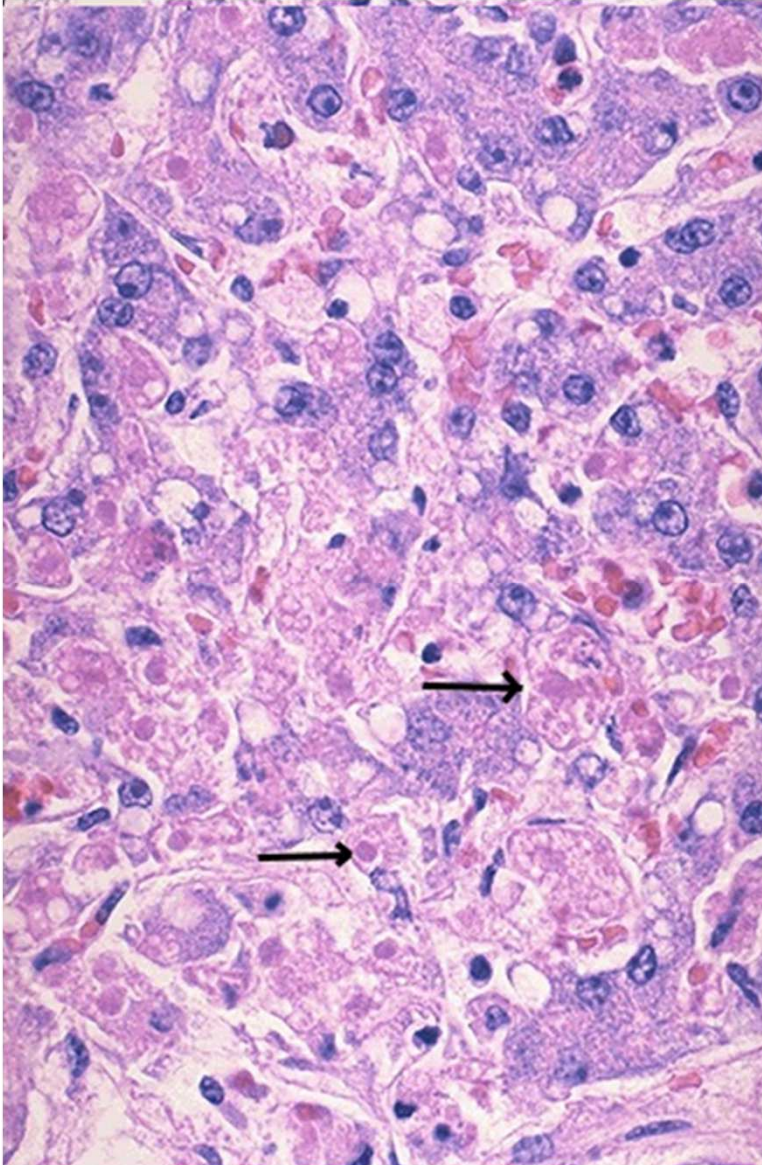

Apoptosis is a more orderly process of cell death.

Apoptosis is individual cell death, not simultaneous localized necrosis of large numbers of cells.

In this example, hepatocytes are dying individually (arrows) from injury through infection by viral hepatitis. The apoptotic cells are enlarged, pink from loss of cytoplasmic detail, and without nuclei. The cell nucleus and cytoplasm become fragmented as enzymes such as caspases destroy cellular components.

Apoptosis in fetal thymus

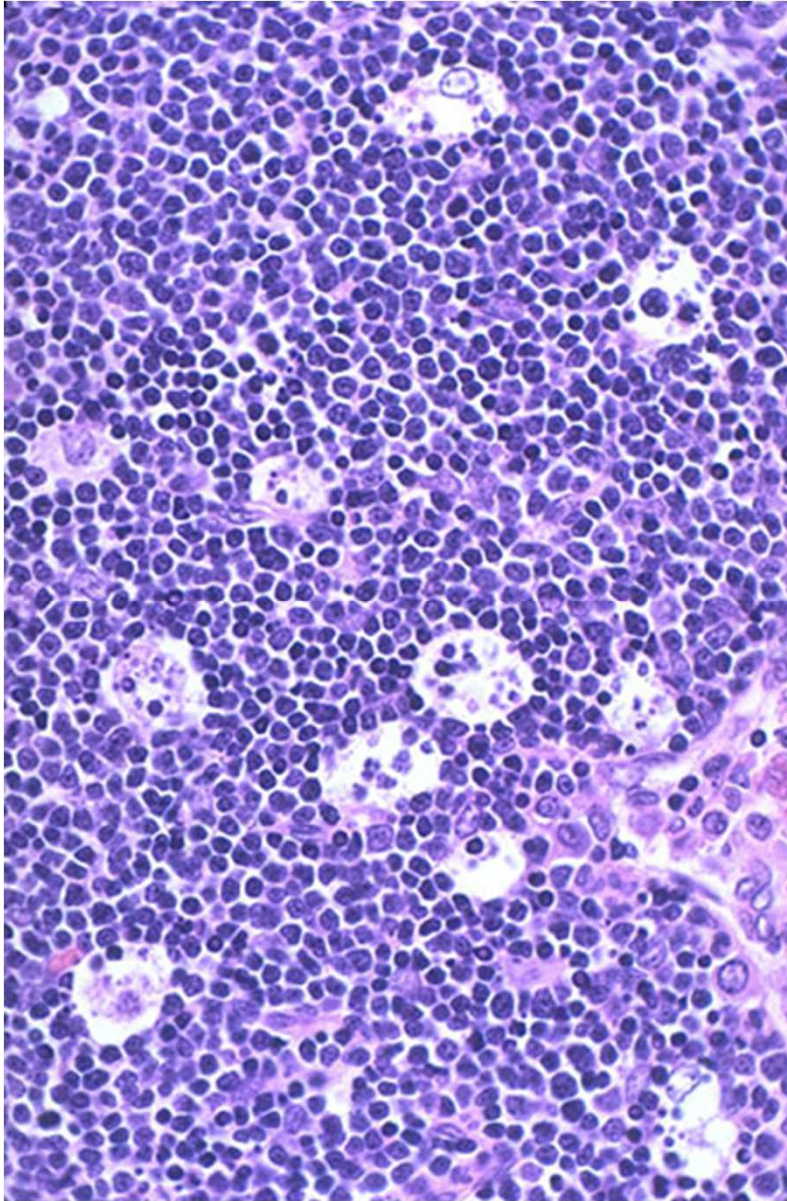

In this fetal thymus there is involution of thymic lymphocytes by the mechanism of apoptosis.

In this case, it is an orderly process and part of normal immune system maturation.

Individual cells fragment and are eliminated by phagocytes giving the appearance of clear spaces filled with cellular debris.

Implications in Tissue Rejection (transplants)

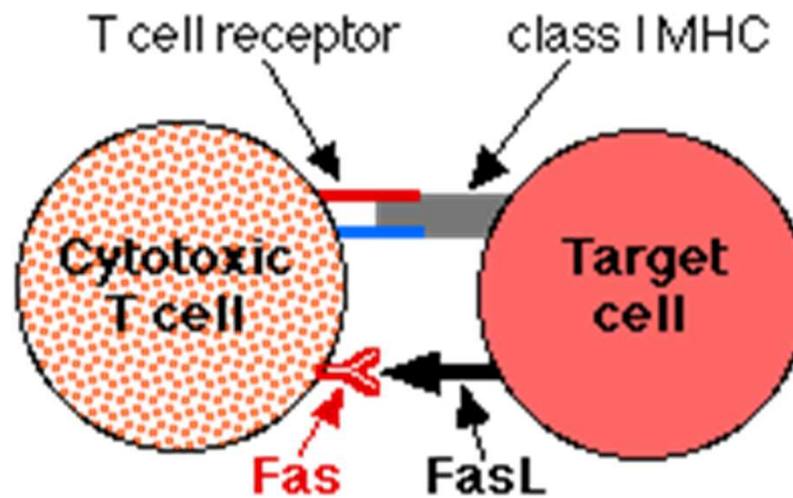

Anterior chamber of the eye and testes fail to elicit an immune response because these cells produce lots of FasL, so kill immune cells when they enter these sites.

Possible therapy by inducing production of FasL in other tissues – lowering need for immune rejection drugs

Alteration of Apoptosis is involved in

- Cancer (via HPV, Epstein bar virus; melanoma)
- regulation of the immune system,
- AIDS,
- organ transplants

Table 3 Correlation between HPV-16 E6 infection and p53 mutation

	HPV-16	
p53	Positive	Negative
Positive	14	7
Negative	12	17

$P > 0.05$; χ^2 test.

Melanoma (the most dangerous type of skin cancer) cells avoid apoptosis by inhibiting the expression of the gene encoding **Apaf-1**.

Review

Guidelines for the use and interpretation of assays for monitoring cell death in higher eukaryotes

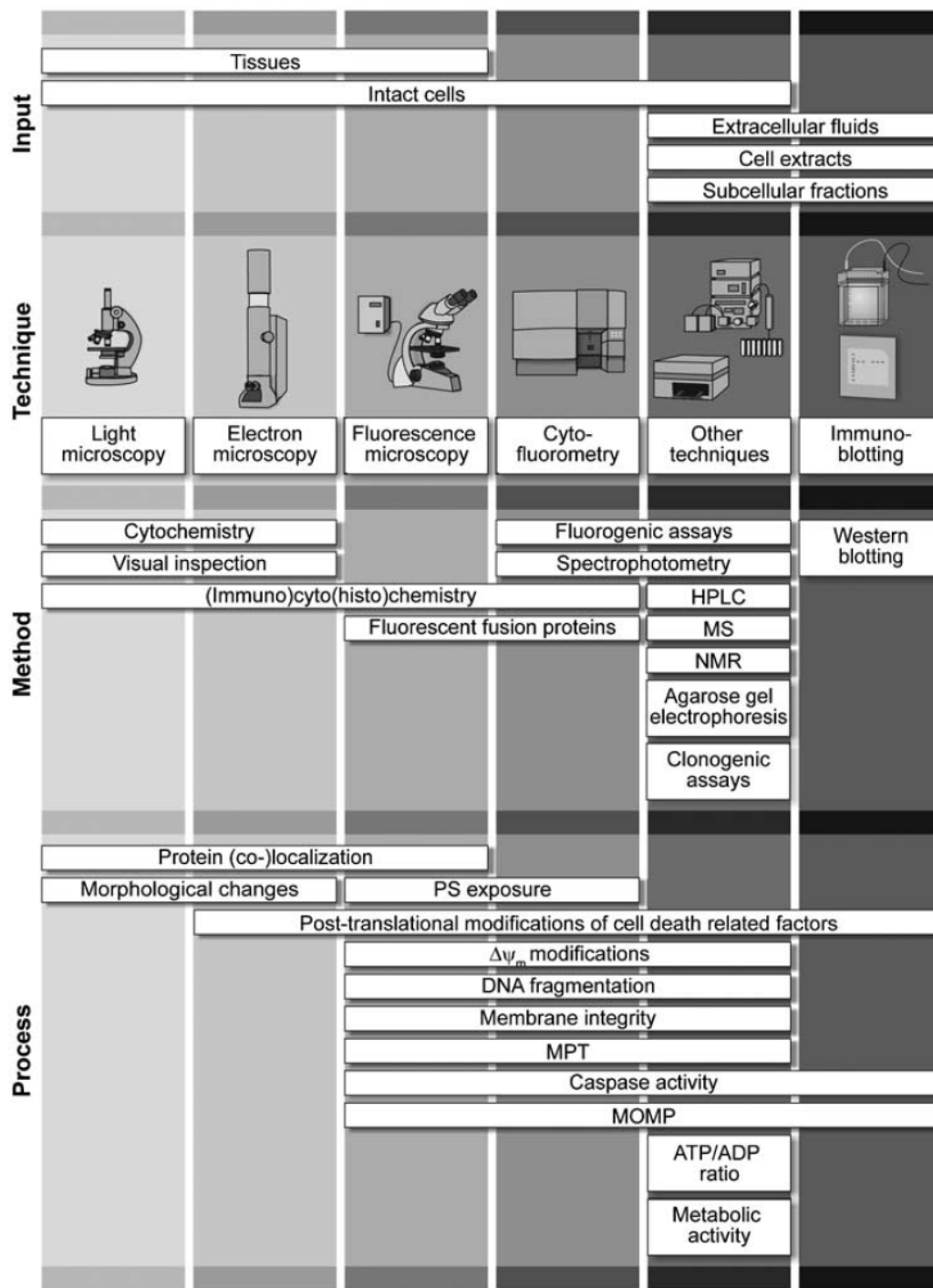
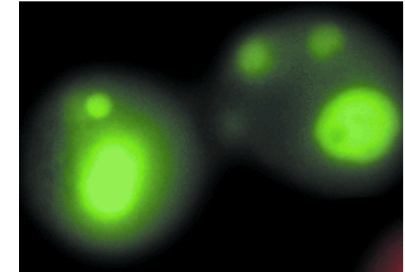
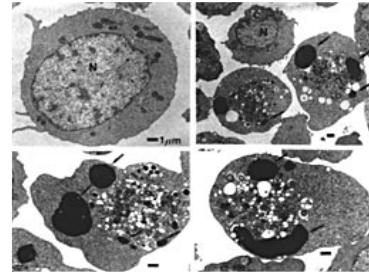

Figure 1. Methods to detect cell death-related variables. Nowadays, a cornucopia of techniques is available to monitor cell death-related parameters. Within this ‘methodological abundance/redundancy’, the choice of the most appropriate techniques and the correct interpretation of results are critical for the success of any study dealing with cell death. Here, the most common procedures to detect dead/dying cells are indicated, together with the technical platforms that are required for their execution and the types of specimens on which they can be applied. Please see the main text for further details. Dcm, mitochondrial transmembrane potential; HPLC, high-pressure liquid chromatography; MOMP, mitochondrial outer membrane permeabilization; MPT, mitochondrial permeability transition; MS, mass spectrometry; NMR, nuclear magnetic resonance; PS, phosphatidylserine; SDS-PAGE, sodium dodecyl sulfate-polyacrylamide gel electrophoresis

Detection of apoptotic changes in DNA:

- Nucleic acid staining – nuclear morphology



- Detection of nuclear DNA fragmentation

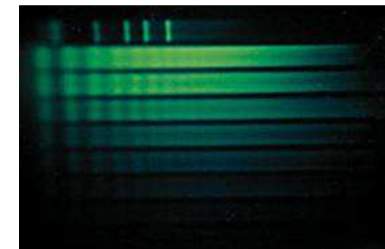

- TUNEL staining
(terminal deoxynucleotidyl transferase–mediated dUTP nick end-labeling)

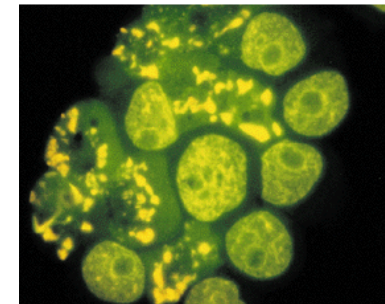

- Single-cell electrophoresis (Comet assay)

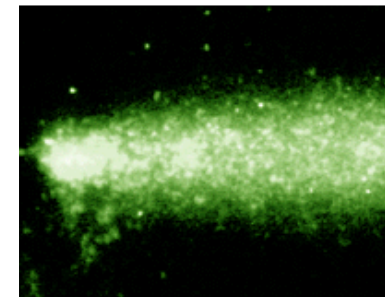

Detection of changes in cell membrane integrity:

- Membrane permeability

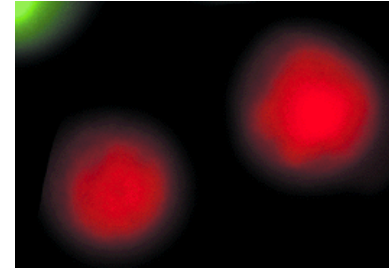

- Phospholipid symmetry (Annexin V staining)

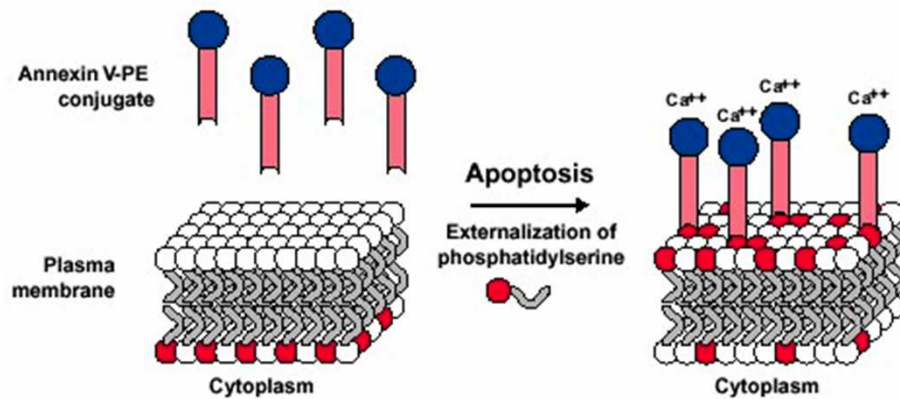

Schematic representation of the Annexin V assay.

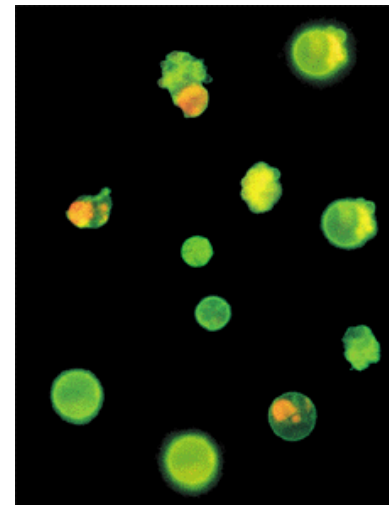

Distinct modalities of cell death

Cell death mode	Morphological features	Notes
Apoptosis	<ul style="list-style-type: none"> • Rounding-up of the cell • Retraction of pseudopodes • Reduction of cellular and nuclear volume (pyknosis) • Nuclear fragmentation (karyorrhexis) • Minor modification of cytoplasmic organelles • Plasma membrane blebbing • Engulfment by resident phagocytes, <i>in vivo</i> 	<p>‘Apoptosis’ is the original term introduced by Kerr <i>et al.</i>¹⁴ to define a type of cell death with specific morphological features. Apoptosis is NOT a synonym of programmed cell death or caspase activation.</p>
Autophagy	<ul style="list-style-type: none"> • Lack of chromatin condensation • Massive vacuolization of the cytoplasm • Accumulation of (double-membraned) autophagic vacuoles • Little or no uptake by phagocytic cells, <i>in vivo</i> 	<p>‘Autophagic cell death’ defines cell death occurring with autophagy, though it may misleadingly suggest a form of death occurring by autophagy as this process often promotes cell survival.^{15,16}</p>
Cornification	<ul style="list-style-type: none"> • Elimination of cytosolic organelles • Modifications of plasma membrane • Accumulation of lipids in F and L granules • Extrusion of lipids in the extracellular space • Desquamation (loss of corneocytes) by protease activation 	<p>‘Cornified envelope’ formation or ‘keratinization’ is specific of the skin to create a barrier function. Although apoptosis can be induced by injury in the basal epidermal layer (e.g., UV), cornification is exclusive of the upper layers (granular layer and stratum corneum).^{17,18}</p>
Necrosis	<ul style="list-style-type: none"> • Cytoplasmic swelling (oncosis) • Rupture of plasma membrane • Swelling of cytoplasmic organelles • Moderate chromatin condensation 	<p>‘Necrosis’ identifies, in a negative fashion, cell death lacking the features of apoptosis or autophagy.⁴ Note that necrosis can occur in a regulated fashion, involving a precise sequence of signals.</p>

A new cell death: Necroptosis

Necroptosis is a programmed form of necrosis, or inflammatory cell death.

Cells can execute necrosis in a programmed fashion. Apoptosis is not always the preferred form of cell death.

The immunogenic nature of necroptosis favors its participation in certain circumstances, such as aiding defense pathogens by the immune system.

- necroptosis is a form of programmed cell death that acts independently of caspase activity. While necroptosis is much less characterized than apoptosis, it is established that serine/threonine kinases RIP1, RIP3, and the mixed lineage kinase domain-like protein, MLKL, are critical for this form of cell death. Another indicator of necroptosis is the formation of what's known as the "Ripoptosome" which is characterized by recruitment of RIP1, FADD and Caspase 8. Interestingly, the Ripoptosome can lead to either caspase-independent necrosis or caspase-mediated apoptosis.

Regulated Necrosis: necrosis can occur in a regulated manner in addition to spontaneous cell death

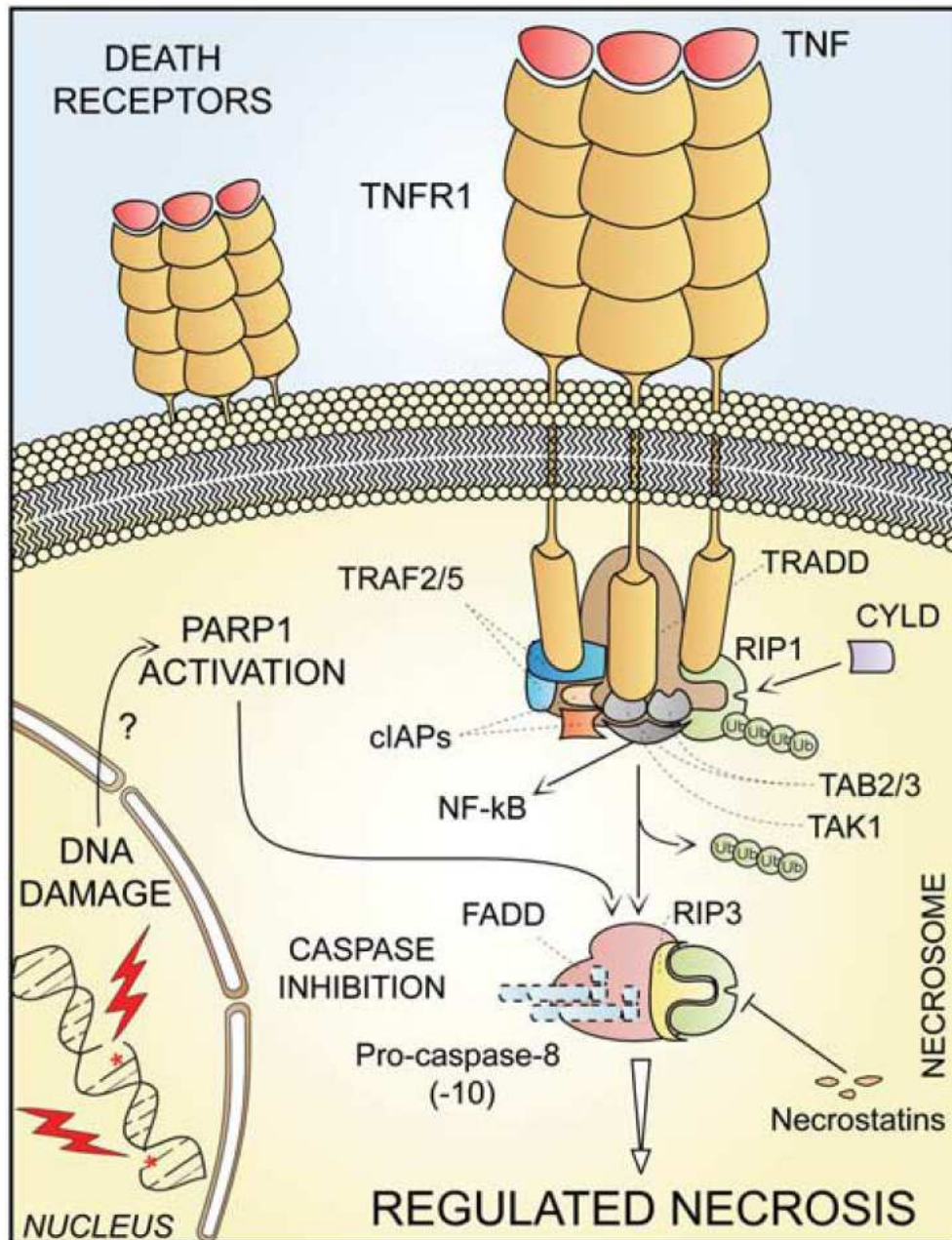

Upon tumor necrosis factor α (TNF α) binding, the cytoplasmic tails of TNF receptor 1 (TNFR1, a prototypic death receptor) trimers recruit TNFR-associated death domain (TRADD), receptor-interacting protein kinase 1 (RIP1), cellular inhibitor of apoptosis 1 (cIAP1), cIAP2, TNFR-associated factor 2 (TRAF2) and TRAF5. Within the so-called complex I, RIP1 is polyubiquitinated by cIAPs, thereby providing a docking site for the recruitment of transforming growth factor β (TGF β)-activated kinase 1 (TAK1), TAK1-binding protein 2 (TAB2) and TAB3 (which together deliver a pro-survival signal by activating the transcription factor NF- κ B). In some pathological and experimental settings, and in particular when caspase-8 is absent or when caspases are inhibited by pharmacological agents, cylindromatosis (CYLD)-deubiquitinated RIP1 engage in physical and functional interactions with its homolog RIP3, ultimately activating the execution of necrotic cell death. Regulated necrosis can also be induced by alkylating DNA damage (possibly by the overactivation of poly(ADP-ribose) polymerase 1, PARP1). In some (but not all) instances, regulated necrosis requires the kinase activity of RIP1, that is, it can be blocked by the RIP1-targeting compounds necrostatins.

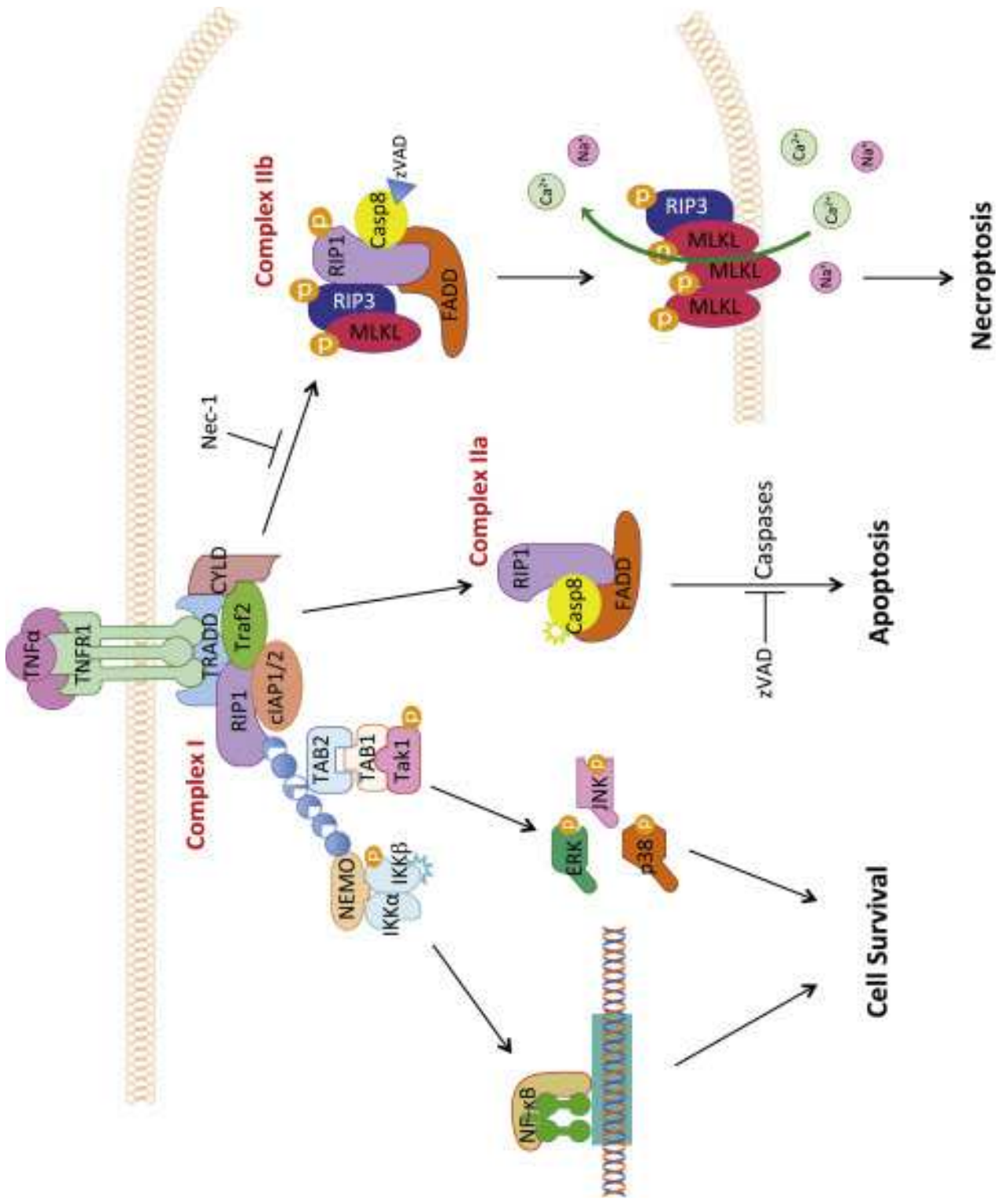

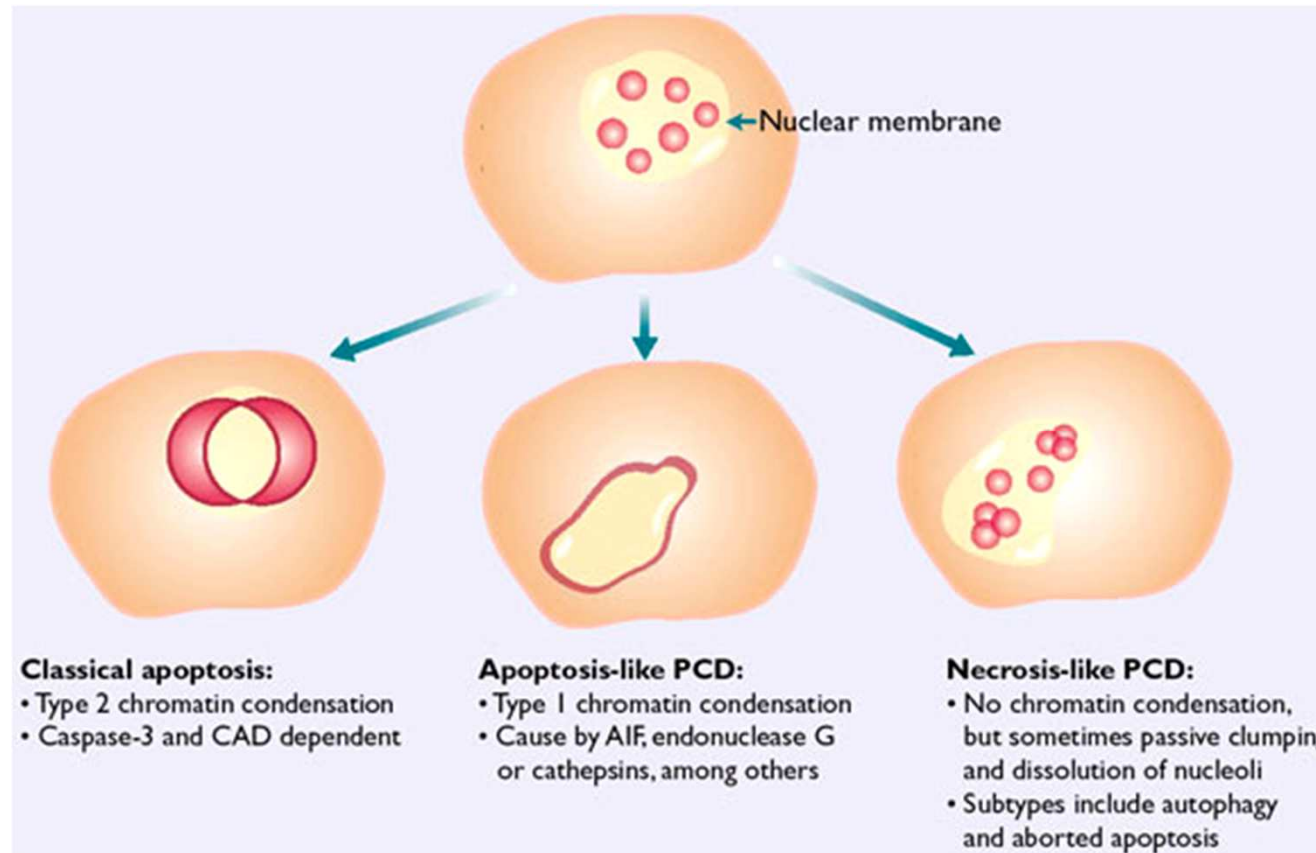

Autophagic cell death (type II programmed cell death) – meaning that the cytoplasm is actively destroyed long before nuclear changes become apparent;

Classical apoptotic cell death – meaning that the chromatin marginates and the cell and nucleus fragment before morphological changes are seen in intracellular organelles

Autophagy and cell death

In response to stress and during development, eukaryotic cells often activate autophagy, a mechanism whereby organelles and portion of the cytoplasm are sequestered in double-membraned vesicles (autophagosomes) that are delivered to lysosomes for degradation (macroautophagy). Microautophagy may also occur.

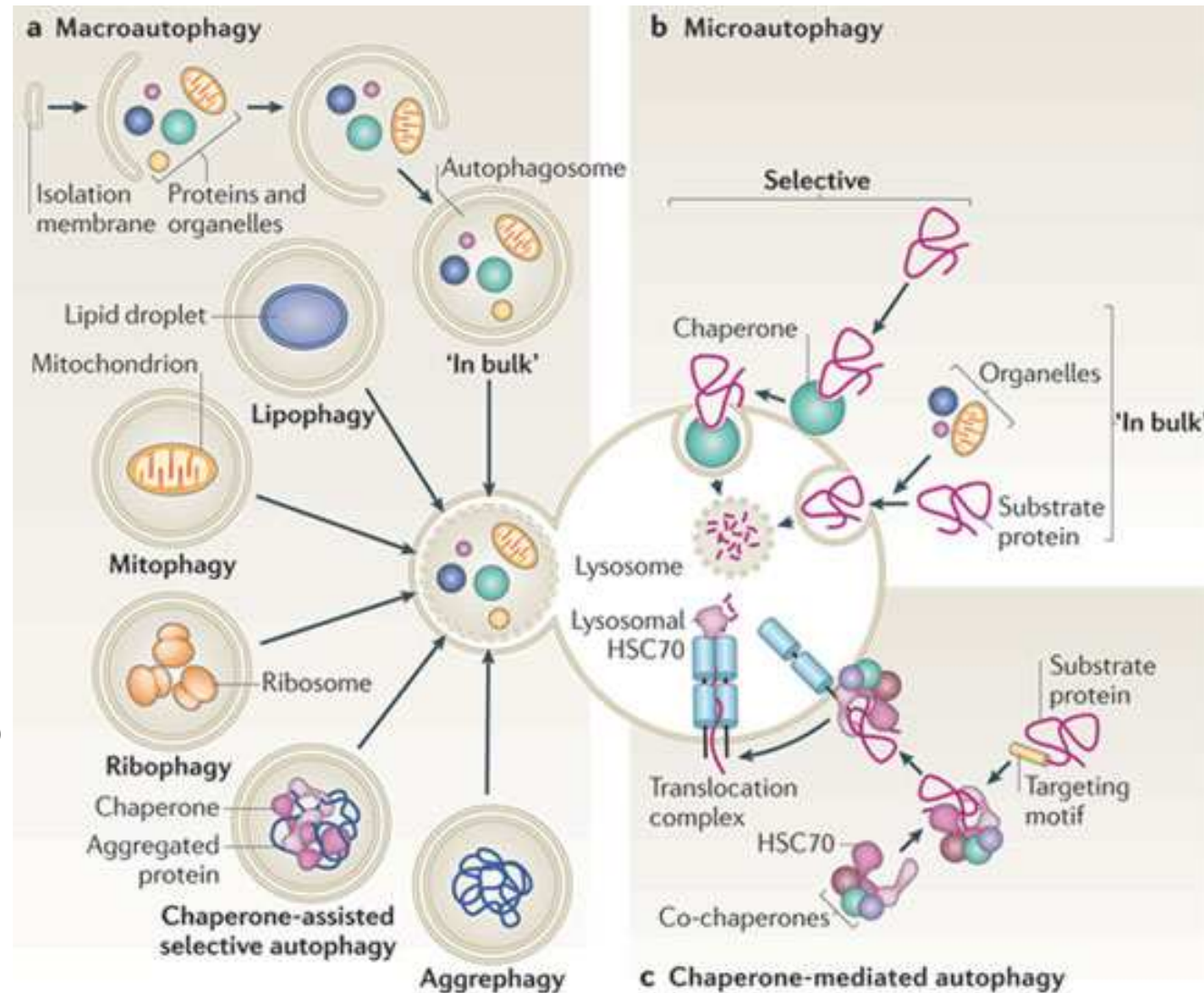

Autophagic cell death: instances of cell death that are accompanied by a massive cytoplasmic vacuolization

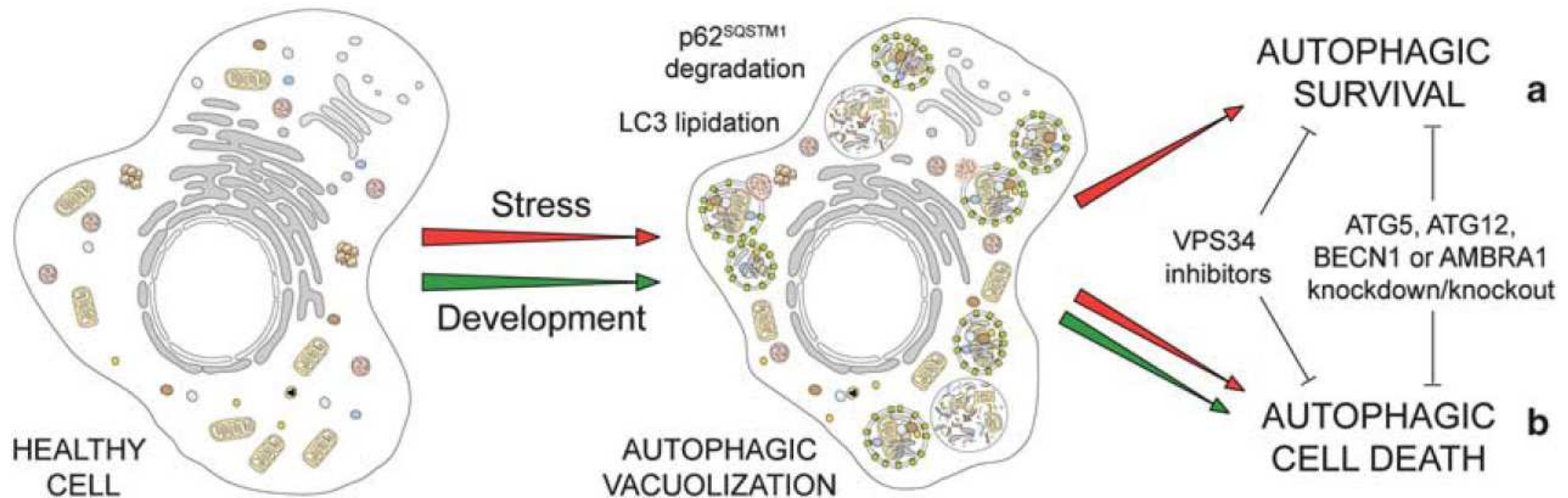

Stress-induced autophagy most often exerts cytoprotective functions and favors the re-establishment of homeostasis and survival (**a**). In this setting, pharmacological or genetic inhibition of autophagy accelerates cell death.

On the other end, these interventions frequently inhibit developmental cell death, indicating that autophagy also constitutes a lethal mechanism that mediates ‘autophagic cell death’ (**b**)

Mitotic catastrophe

- The improper distribution of chromosomes during mitosis compromises cellular functions and can reduce cellular fitness or contribute to malignant transformation.
- As a countermeasure, higher eukaryotes have developed strategies for eliminating mitosis-incompetent cells, one of which is mitotic catastrophe.

Mitotic catastrophe is driven by a complex and poorly understood signalling cascade but, from a functional perspective, it can be defined as an oncosuppressive mechanism that precedes (and is distinct from) apoptosis, necrosis or senescence.

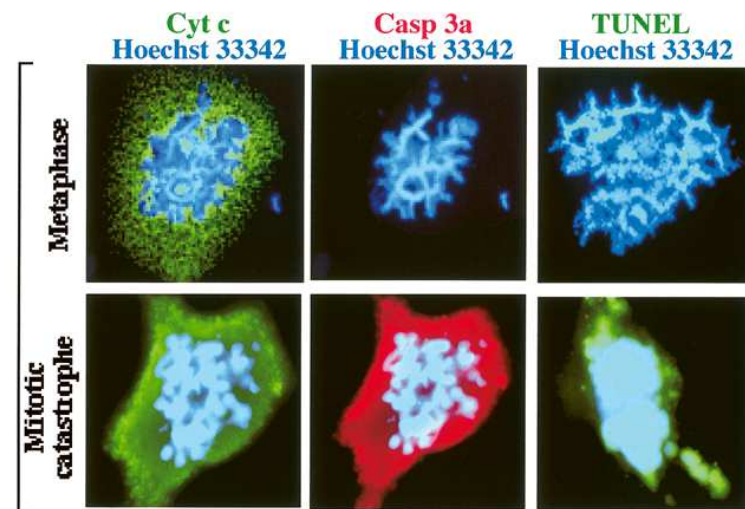

Mitotic catastrophe:

- cell death occurring in mitosis
- cases of cell death that are triggered by aberrant mitosis and executed either during mitosis or in the subsequent interphase

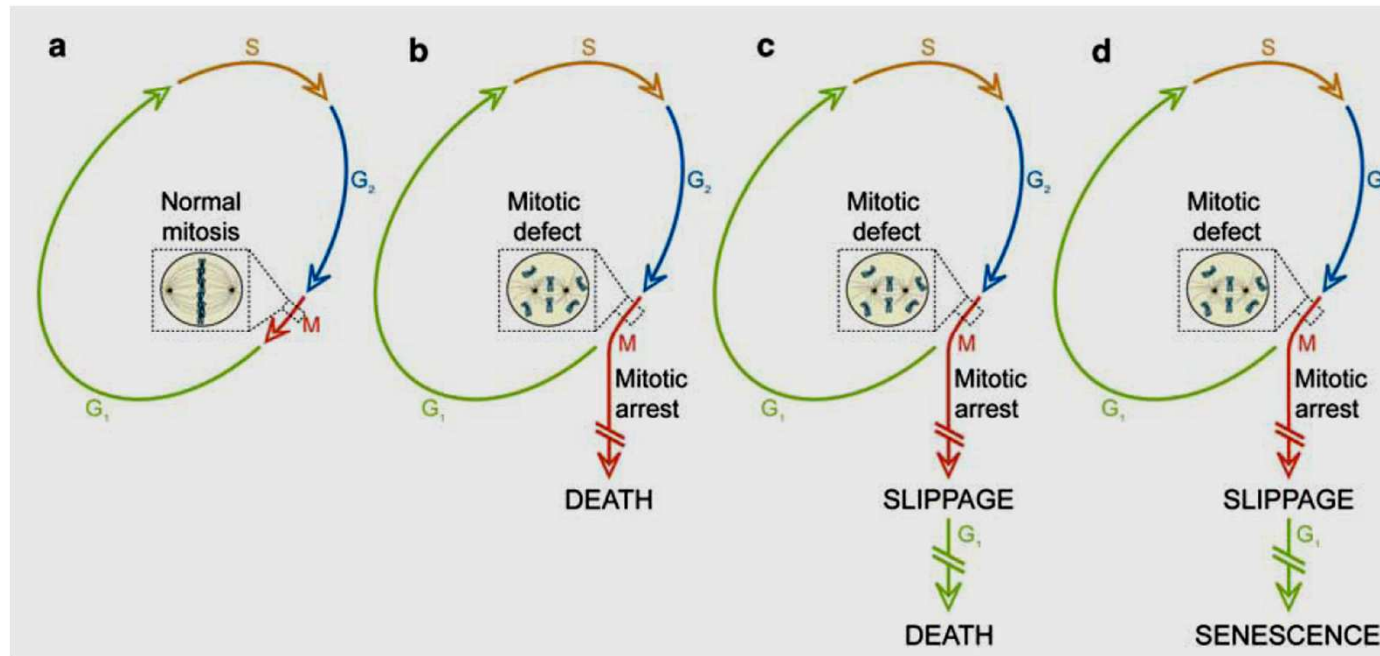

- In the absence of perturbations of the mitotic apparatus (including chromosomes and the molecular machinery that ensures their faithful segregation), cells progress through the cell cycle to generate a diploid offspring (**a**)
- On the contrary, if chromosomal defects or problems affecting the mitotic machinery are sensed during the M phase, cells become arrested in mitosis due to the activation of mitotic catastrophe:
 - These cells can undergo different fates: they can die without exiting mitosis (**b**),
 - reach the G₁ phase of the subsequent cell cycle (through a phenomenon that is known as mitotic slippage) and then die (**c**),
 - or exit mitosis and undergo senescence (**d**).

mitotic catastrophe

- mitotic catastrophe can be described as a mechanism that senses mitotic failure and responds to it by driving the cell to an irreversible fate, be it apoptosis, necrosis or senescence.
- According to this designation, mitotic catastrophe should be viewed as a bona fide oncosuppressive cascade that precedes and is distinct from, yet operates through, antiproliferative measures, including cell death and senescence.

