Chirp

Pierfrancesco Lombardo

CHIRP: linear frequency modulated signal

MAXIMUM RADAR RANGE

$$R_{\max} = 4 \sqrt{\frac{E_T G^2 \lambda^2 \sigma}{(4\pi)^3 K T_0 F S_a}} \quad \text{Con } E_T = P_p T$$

RANGE RESOLUTION

$$R_d = \frac{cT}{2}$$

CHIRP: LINEAR FREQUENCY MODULATION

$$s(t) = e^{j2\pi(f_p t + \frac{B}{T} \cdot \frac{t^2}{2})} \text{rect}_T(t)$$

B chirp bandwidth
T transmitted pulse length
 f_p (residual) carrier frequency

- CHIRP (long pulse with phase coding): has the power properties of the long pulse and the resolution properties of the short pulse.
- Phase coding → waveform compression by means of matched filtering

CHIRP: Time domain waveform (I)

$$s(t) = e^{j2\pi(f_p t + \frac{B}{T} \cdot \frac{t^2}{2})} \text{rect}_T(t)$$

- CHIRP MODULUS DEL $|s(t)|$:

$$|s(t)| = \begin{cases} 1 & \text{Per } |t| \leq T/2 \\ 0 & \text{Per } |t| \geq T/2 \end{cases}$$

- CHIRP PHASE $\Phi(t)$

$$\Phi(t) = 2\pi(f_p t + \frac{B}{T} \cdot \frac{t^2}{2})$$

- INSTANTANEOUS FREQUENCY $f(t)$

$$f(t) = \frac{1}{2\pi} \cdot \frac{d\Phi(t)}{dt} = f_p + \frac{B}{T} t$$

$$f(-T/2) = f_p - B/2$$

$$f(T/2) = f_p + B/2$$

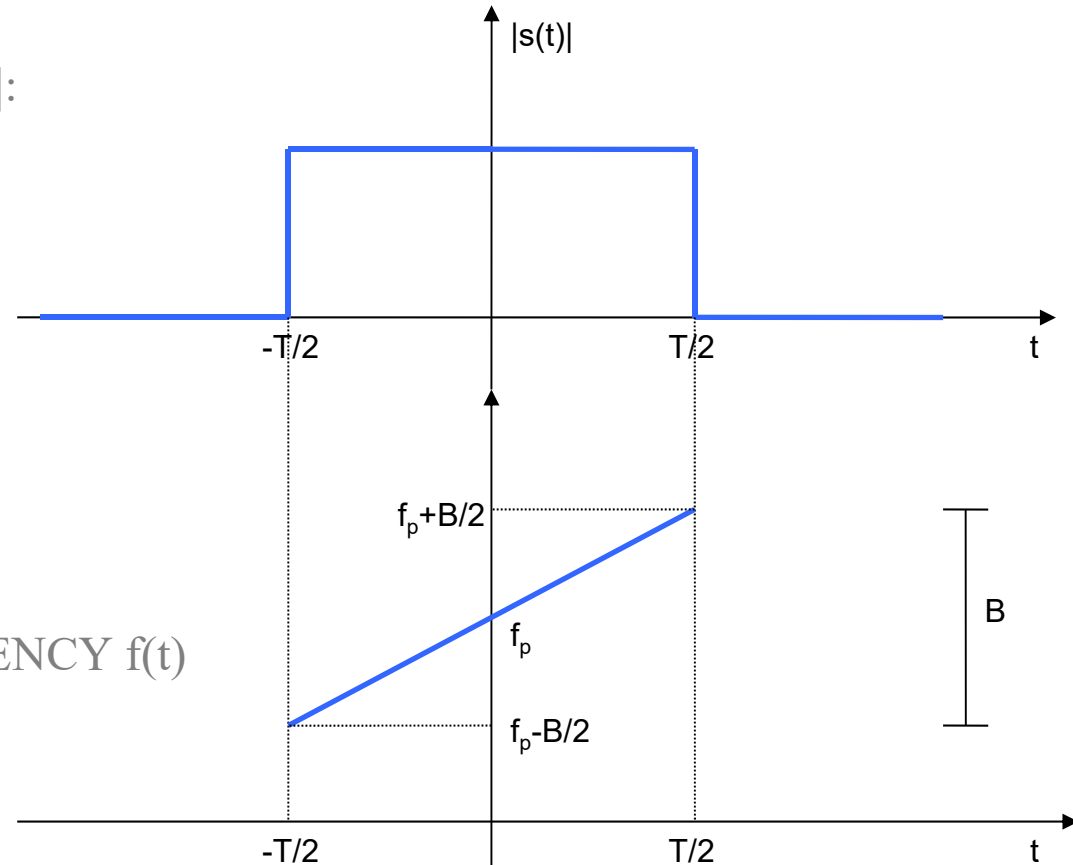

Frequency modulation

CHIRP: Time domain waveform (II)

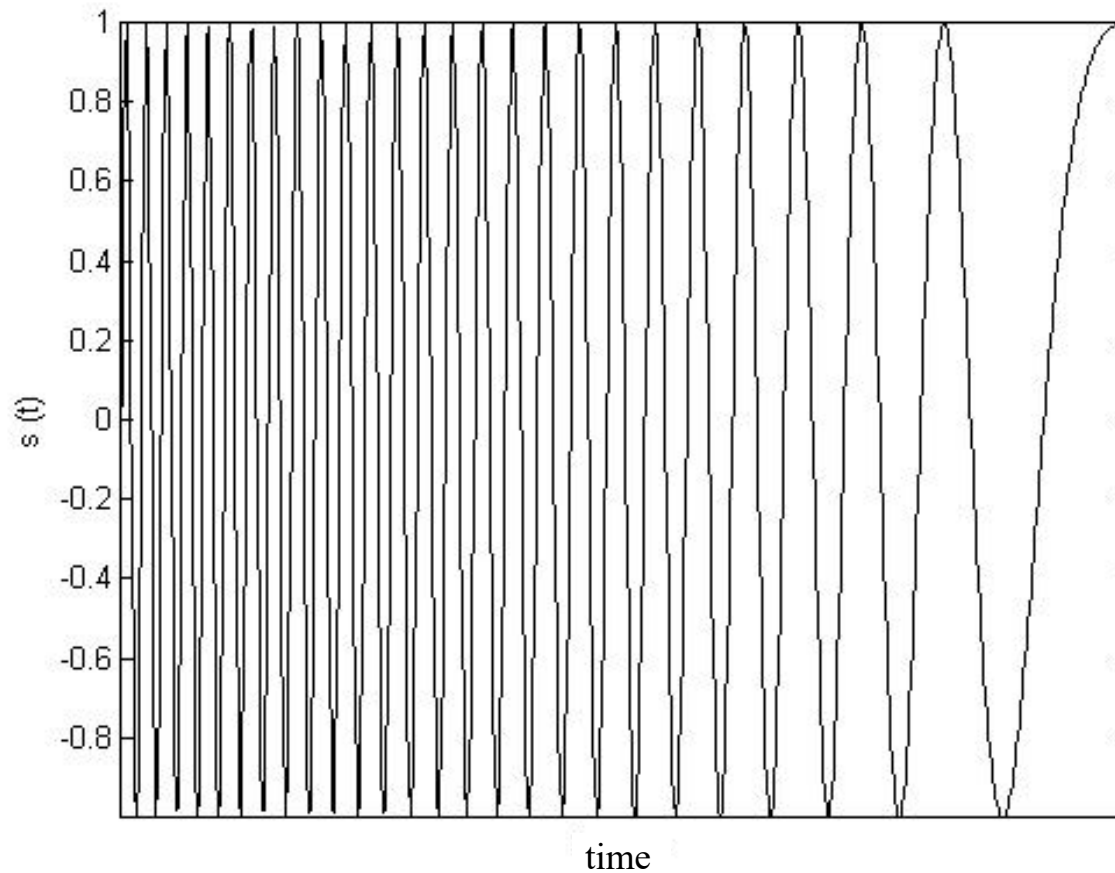

CHIRP: Time domain waveform (III)

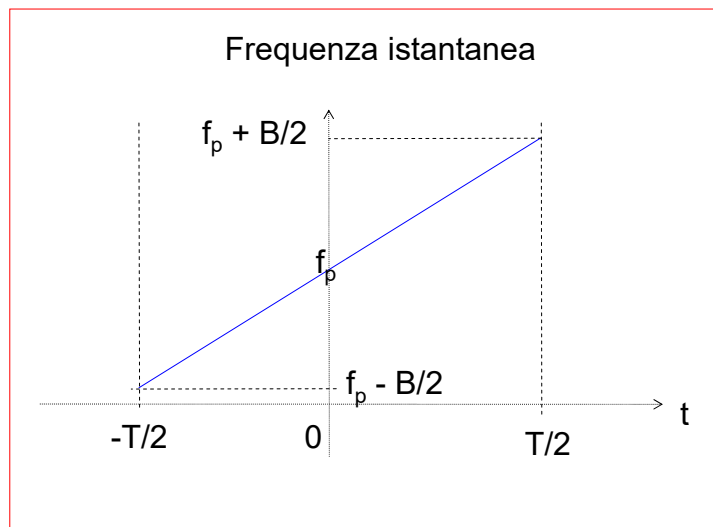
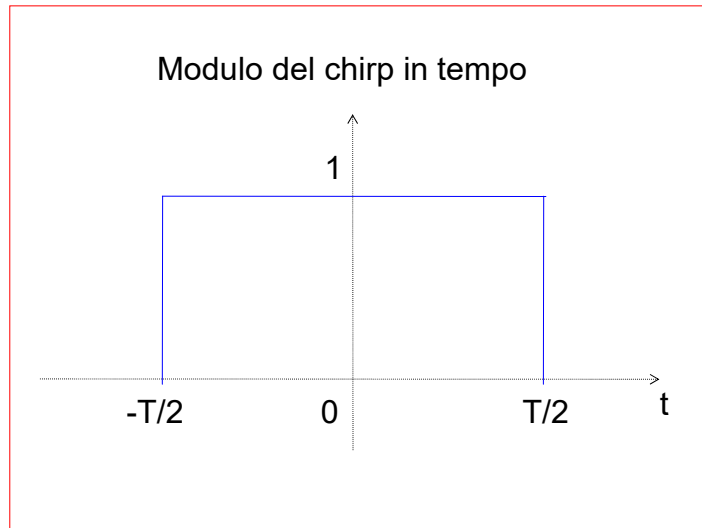

Funzioni Coseno e Seno Integrale

$$C(z) = \text{fresnelc}(z) = \int_0^z \cos\left(\frac{\pi t^2}{2}\right) dt$$

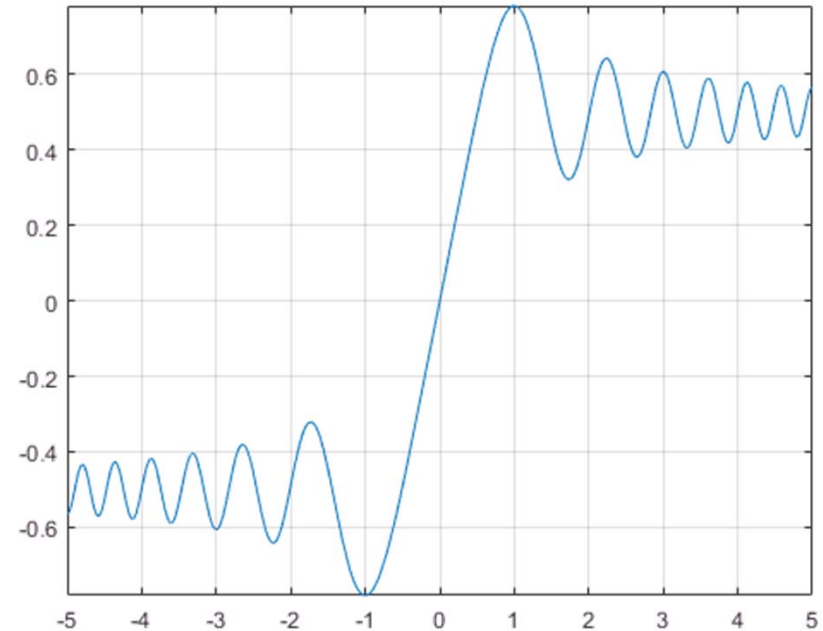
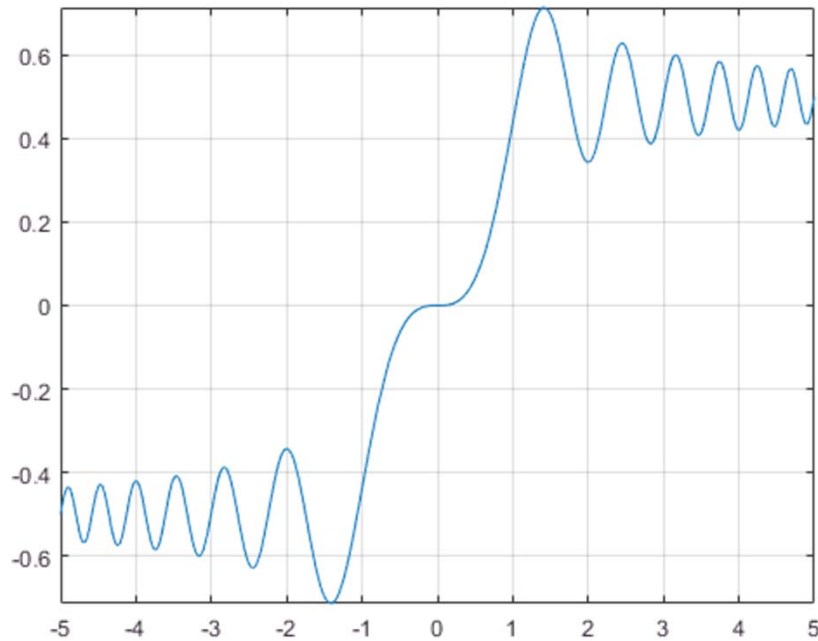

$$S(z) = \text{fresnels}(z) = \int_0^z \sin\left(\frac{\pi t^2}{2}\right) dt$$

Spettro del Chirp

$$S(f) = \int_{-\tau/2}^{\tau/2} e^{j\pi \frac{B}{\tau} t^2} e^{-j2\pi f t} dt$$

CHIRP: Frequency domain waveform (I)

Fourier Transform of the chirp signal:

$$S(f) = \frac{1}{\sqrt{2\mu}} \{ [C(X_1) + C(X_2)] + j[S(X_1) + S(X_2)] \} e^{-j\frac{\pi}{\mu}f^2} = |S(f)| e^{j\Phi(f)}$$

✓ The compression factor BT determines the frequency domain characteristics of the chirp waveform

$C(X)$ Fresnel cosine

$S(X)$ Fresnel sine

$$X_1 = \sqrt{2BT} \left(\frac{1}{2} + \frac{f}{B} \right)$$

$$X_2 = \sqrt{2BT} \left(\frac{1}{2} - \frac{f}{B} \right)$$

AMPLITUDE SPECTRUM

$$|S(f)| = \frac{1}{\sqrt{2\mu}} \sqrt{[C(X_1) + C(X_2)]^2 + [S(X_1) + S(X_2)]^2}$$

For high BT values ($BT > 100$)

$$|S(f)| \cong \frac{1}{\sqrt{2\mu}} \sqrt{2} = \frac{1}{\sqrt{\mu}} = \sqrt{\frac{T}{B}} \quad |f| \leq B/2$$

PHASE SPECTRUM

$$\Phi(f) = -\frac{\pi}{\mu} f^2 + \text{atg} \left[\frac{S(X_1) + S(X_2)}{C(X_1) + C(X_2)} \right]$$

For high BT values ($BT > 100$)

$$\Phi(f) \cong -\frac{\pi}{\mu} f^2 + \frac{\pi}{4} \quad |f| \leq B/2$$

$$S(f) = \sqrt{\frac{T}{B}} e^{-j \left[\pi \frac{T}{B} f^2 - \frac{\pi}{4} \right]} \text{rect}_B(f)$$

CHIRP: Frequency domain waveform (II)

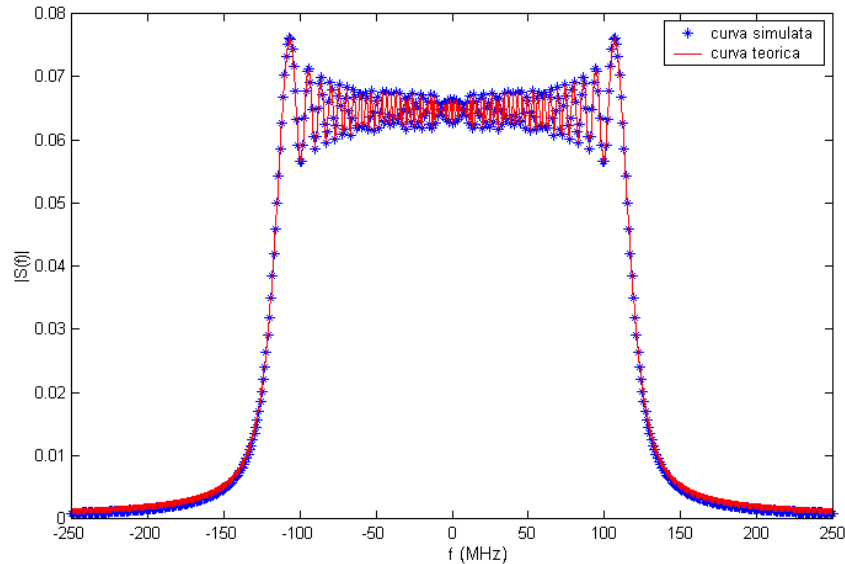

Chirp amplitude spectrum for
 $B=240\text{MHz}$, $T=1\mu\text{s}$

Chirp phase spectrum for
 $B=240\text{MHz}$, $T=1\mu\text{s}$

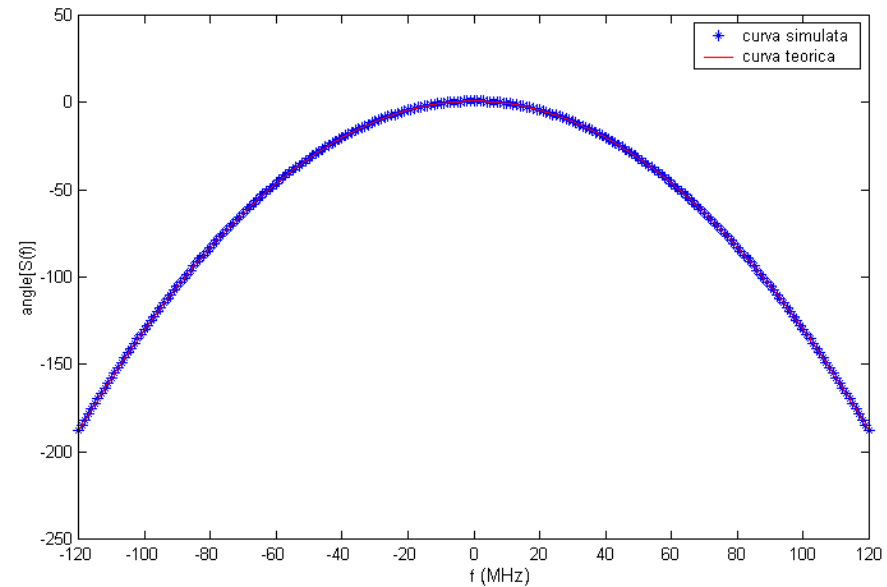

CHIRP: Frequency domain waveform (III)

Unmodulated RF pulse.
 $t_p \cdot \beta_3 = 1.$

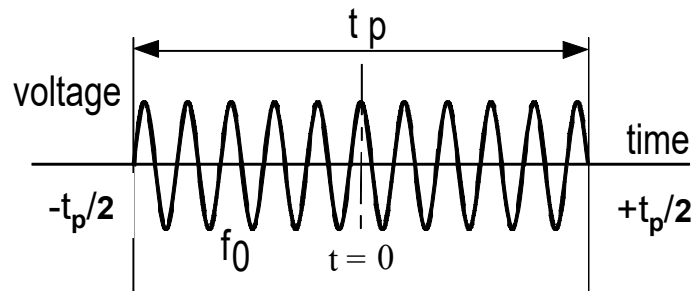

3dB bandwidth $\beta_3 = 1/t_p$

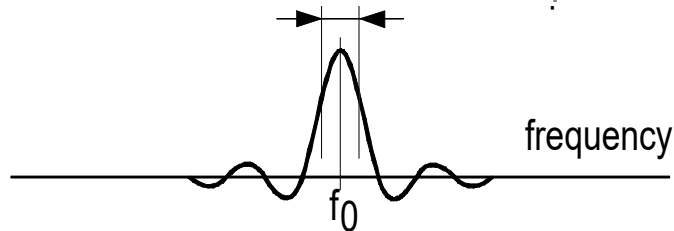

UP-sweep linear
FM chirp pulse.

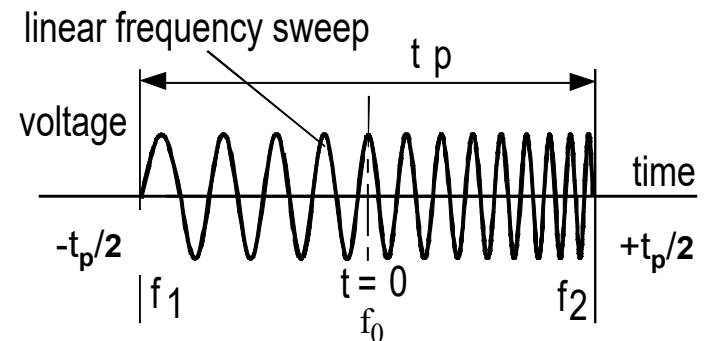

Sweep bandwidth $\beta_s = (f_2 - f_1)$

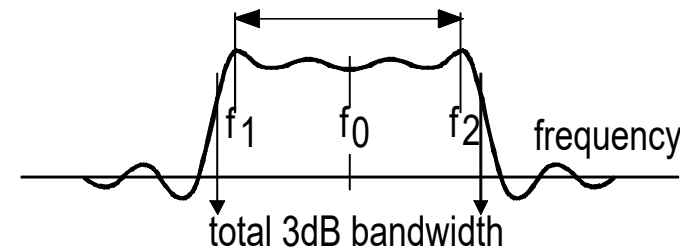

Autocorrelazione del chirp (I)

Funzione di Ambiguità: Chirp con involuppo rettangolare

$$s_0(t) = \frac{1}{\sqrt{\tau_p}} \text{rect}_{\tau_p}(t) e^{j\pi k t^2}$$

$$|\chi(\tau, 0)| = \left| \left(1 - \frac{|\tau|}{\tau_p}\right) \text{sinc}\left[\pi k \tau \tau_p \left(1 - \frac{|\tau|}{\tau_p}\right)\right] \right|, \quad |\tau| \leq \tau_p$$

Primo nullo

$$\pi k \tau \tau_p \left(1 - \frac{|\tau|}{\tau_p}\right) = \pi$$

$$\tau \tau_p - \tau^2 = \frac{1}{k}$$

$$\tau^2 - \tau \tau_p + \frac{1}{k} = 0$$

$$\tau = \frac{\tau_p}{2} - \sqrt{\frac{\tau_p^2}{4} - \frac{1}{k}}$$

$$= \frac{\tau_p}{2} - \frac{\tau_p}{2} \sqrt{1 - \frac{4}{k\tau_p^2}}$$

$$\approx \frac{\tau_p}{2} - \frac{\tau_p}{2} \left(1 - \frac{2}{k\tau_p^2}\right) = \frac{1}{k\tau_p} = \frac{1}{B_p}$$

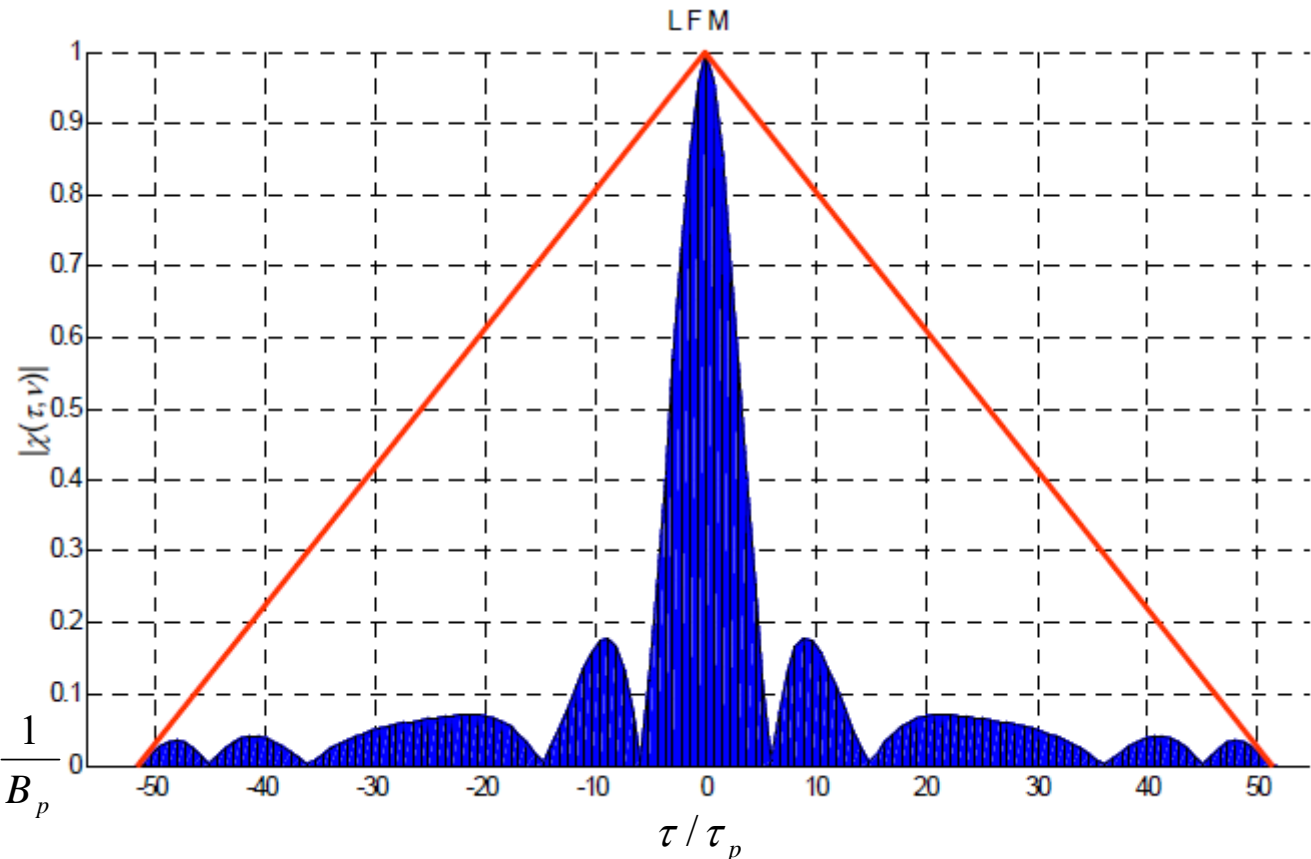

Radiotecnica e Radiolocalizza

Funzione di autocorrelazione del chirp (III)

Funzione di Ambiguità: Chirp con involuppo rettangolare

$$s_0(t) = \frac{1}{\sqrt{\tau_p}} \text{rect}_{\tau_p}(t) e^{j\pi k t^2}$$

$$|\chi(\tau, 0)| = \left| \left(1 - \frac{|\tau|}{\tau_p}\right) \text{sinc}\left[\pi k \tau \tau_p \left(1 - \frac{|\tau|}{\tau_p}\right)\right] \right|, \quad |\tau| \leq \tau_p$$

Rapporto di compressione

$$\frac{\tau_p}{1} = k \tau_p^2 = B_p \tau_p$$

$$\frac{1}{k \tau_p}$$

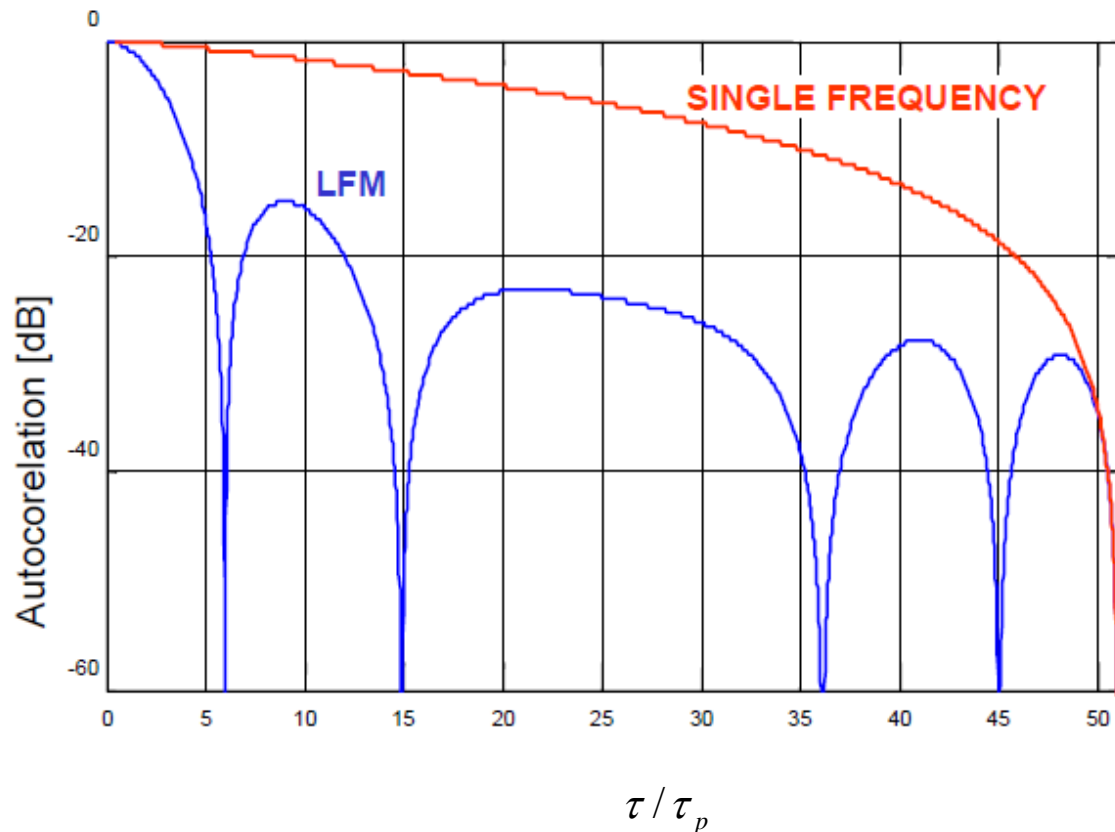

Chirp approximation and sidelobes (I)

- Chirp autocorrelation
(matched filter output)

$$g(t) = \sqrt{\frac{B}{T}} \frac{\sin \left[\pi \frac{B}{T} (T - |t|) t \right]}{\pi \frac{B}{T} t}$$

- approximated with

$$g(t) \cong \sqrt{\frac{B}{T}} \frac{\sin [\pi B t]}{\pi \frac{B}{T} t} = \sqrt{B T} \operatorname{sinc} [\pi B t]$$

which is the Inverse Fourier Transform of
a rectangle in the frequency domain

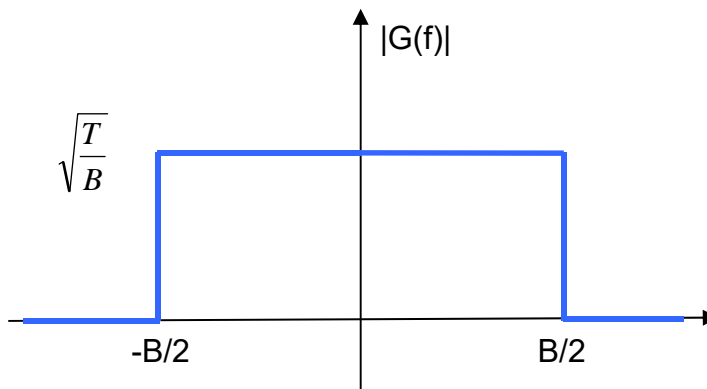

$$G(f) = \sqrt{\frac{T}{B}} \operatorname{rect}_B(f)$$

Pulse compression technique (I)

- Matched Filter

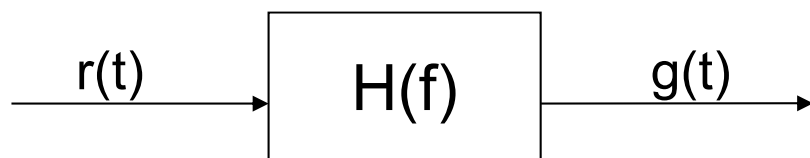

$$r(t) = e^{j2\pi\left(f_p t + \frac{B}{T} \frac{t^2}{2}\right)} \text{rect}_T(t)$$

Received signal

$$h(t) = \sqrt{\frac{B}{T}} e^{-j2\pi\left(-f_p t + \frac{B}{T} \frac{t^2}{2}\right)} \text{rect}_T(t)$$

matched filter
impulse response

$$g(t) = r(t) * h(t) = \int_{-\infty}^{\infty} r(\tau) h(t - \tau) d\tau$$

matched filter
output

$$g(t) = \sqrt{\frac{B}{T}} \frac{\text{sen}\left[\pi \frac{B}{T} (\tau - |t|) t\right]}{\pi \frac{B}{T} t} e^{j2\pi f_p t}$$

sin x/x signal envelope:
with -4dB aperture = 1/B.

- ✓ $g(t)$ autocorrelation of the input signal ($f_d=0$).
- ✓ for $f_d \neq 0$ mismatched filter

The pulse has been
compressed to:
 $\tau_c = 1/B < T$

Pulse compression technique (II)

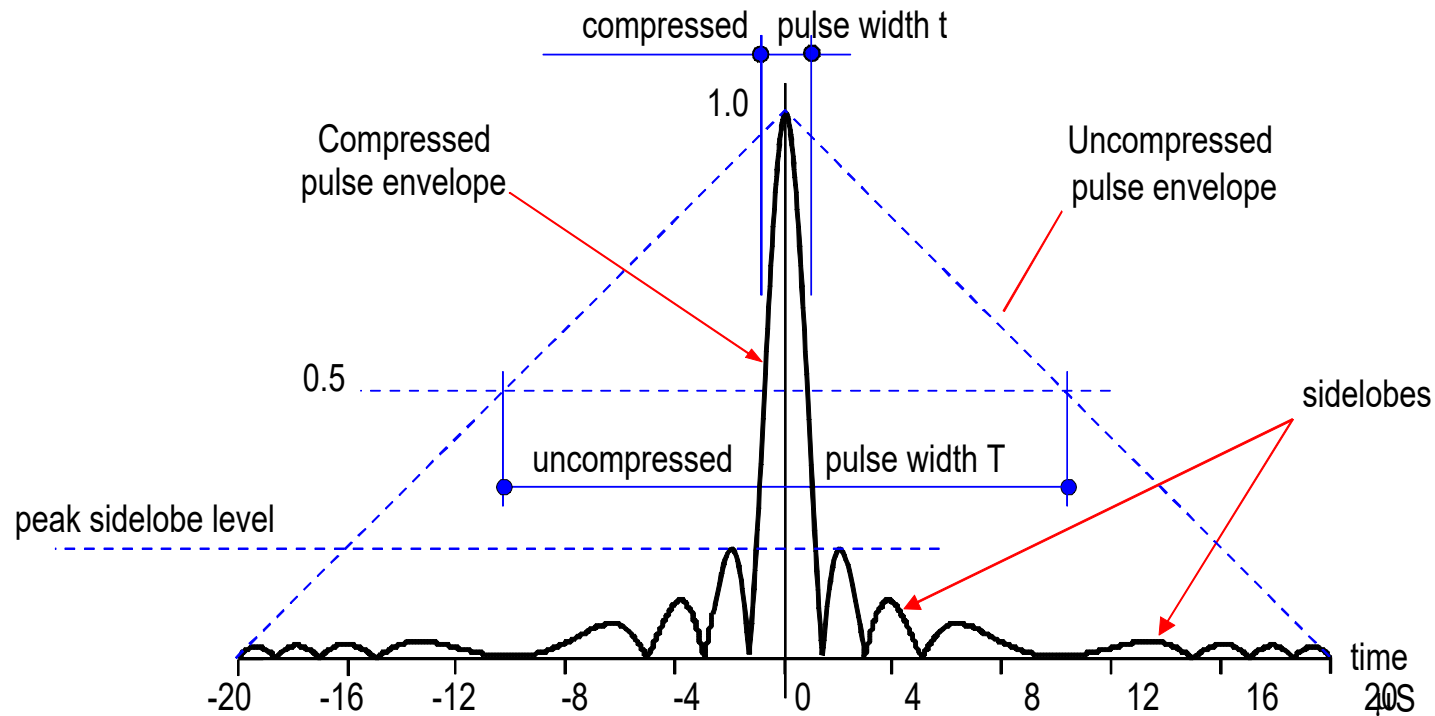

The width of the main lobe of the compressed pulse is $1/\beta_s$ ie. $\frac{1}{\text{sweep bandwidth}}$

Pulse compression technique (III)

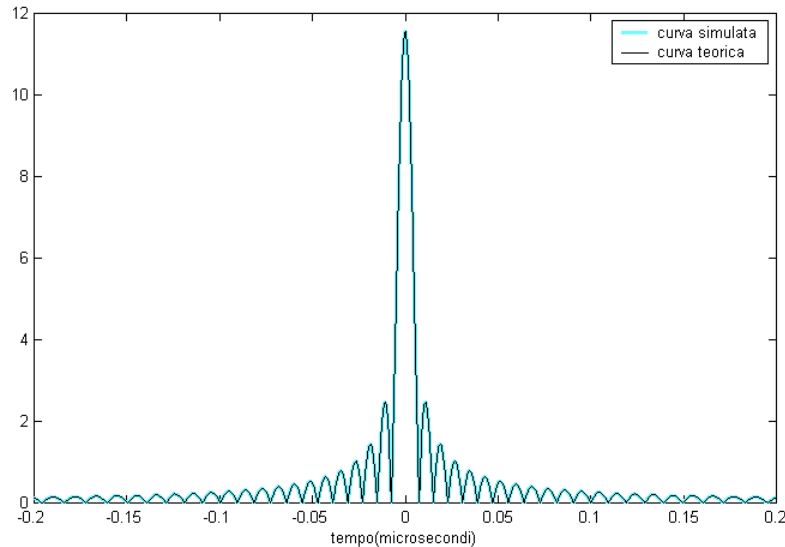

Matched filter output
for: $B=133.5$ MHz
and $T=1$ μ s

Matched filter output

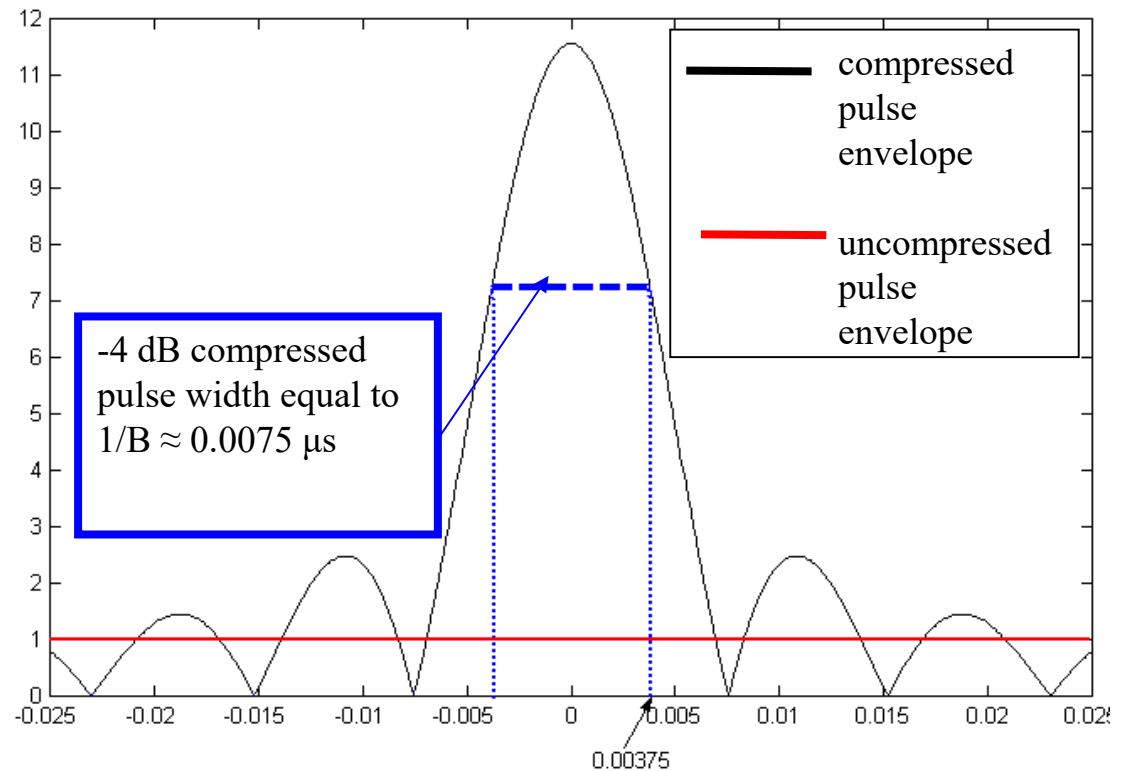

Pulse compression technique (IV)

Matched filter output : sidelobes

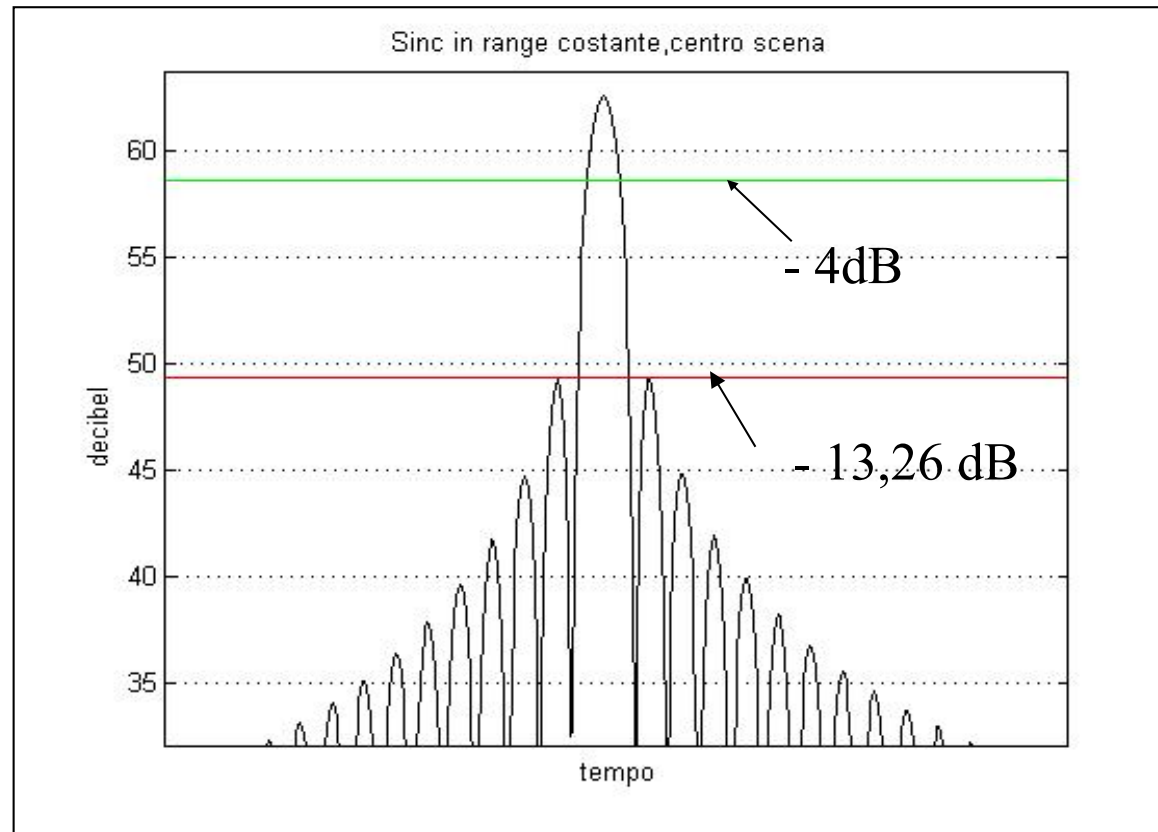

SAW pulse compression (I)

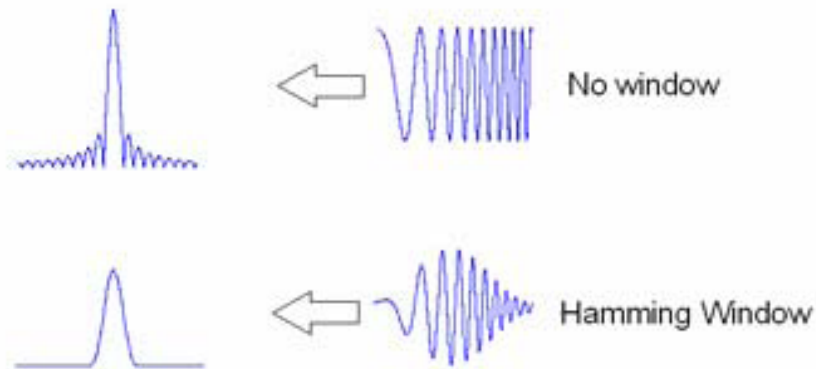
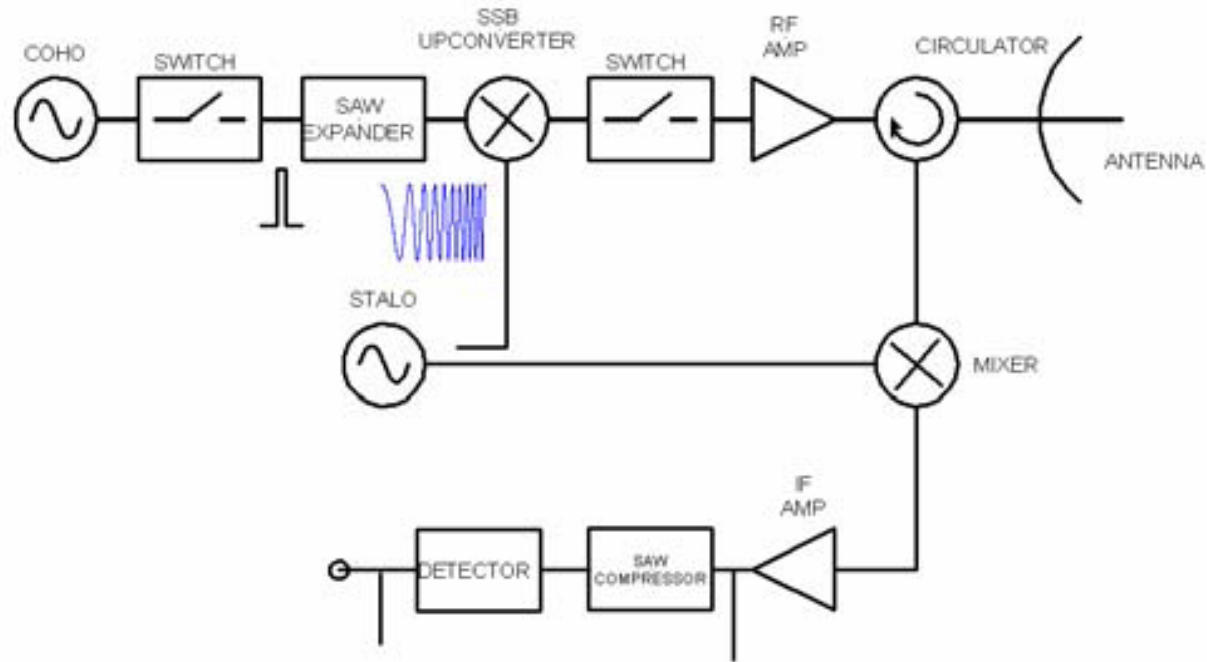

SAW pulse compression (II)

- In a pulse compression system, a very brief pulse consisting of a range of frequencies passes through a dispersive delay line (SAW expander) in which its components are delayed in proportion to their frequency.
- In the process the pulse is stretched; for example a 1ns pulse may be lengthened by a factor of 1000 to a duration of 1 μ s before it is up-converted amplified and transmitted.
- A constant amplitude waveform is produced in which the frequency increases or decreases linearly by Δf over the duration of the pulse

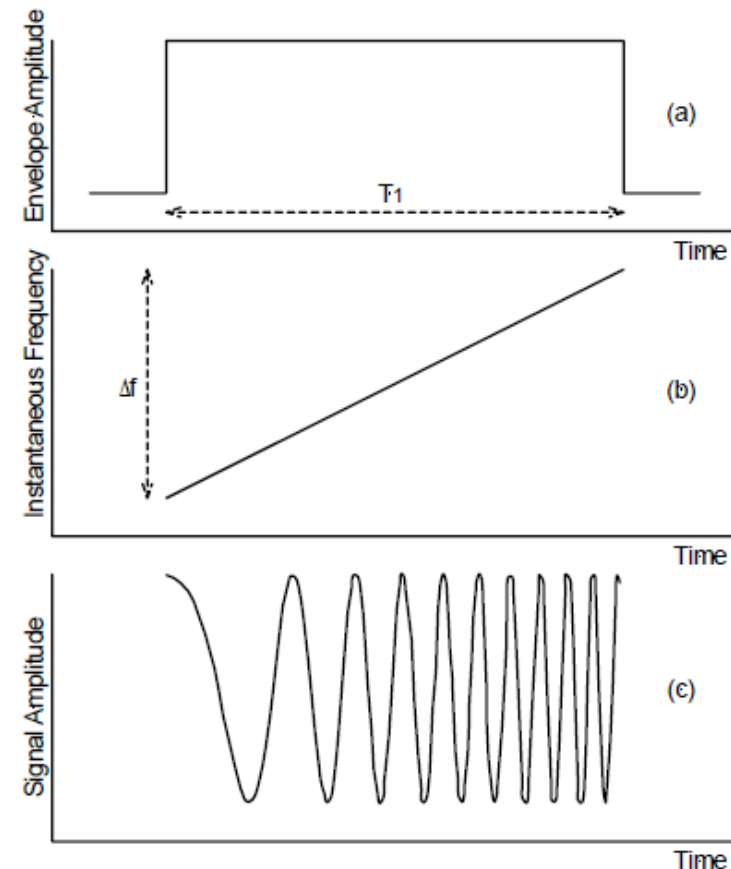

SAW pulse compression (III)

- The echo returns from the target are down converted and amplified
- It is then passed through a pulse compression filter which is designed so that the velocity of propagation is proportional to frequency
- The pulse is compressed to a width $1/\Delta f$
- The compressed echo yields nearly all of the information that would have been available had the unaltered 1ns pulse been transmitted.
- The amount of signal-to-noise ratio (SNR) gain achieved is approximately equivalent to the pulse time-bandwidth product $\beta \cdot \tau$.
- Most pulse compression systems use surface acoustic wave (SAW) technology to implement the pulse expansion and compression functions
- The maximum $\beta \cdot \tau$ product that is readily available is about 1000.

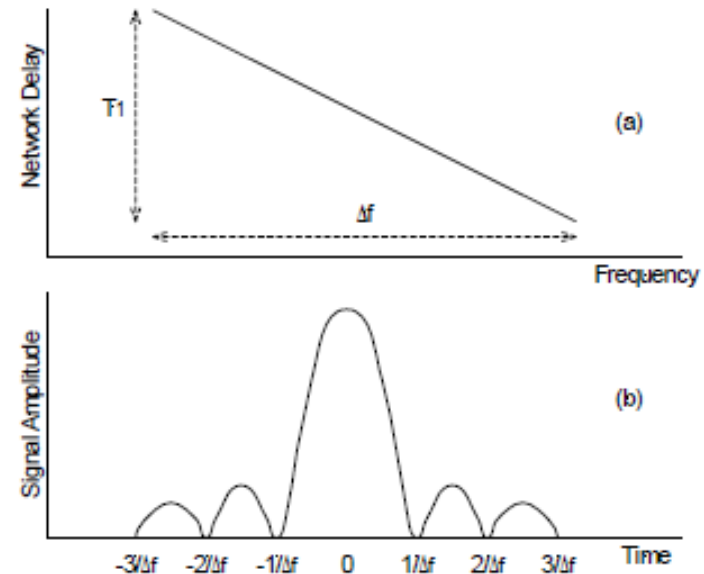

SAW pulse compression (IV)

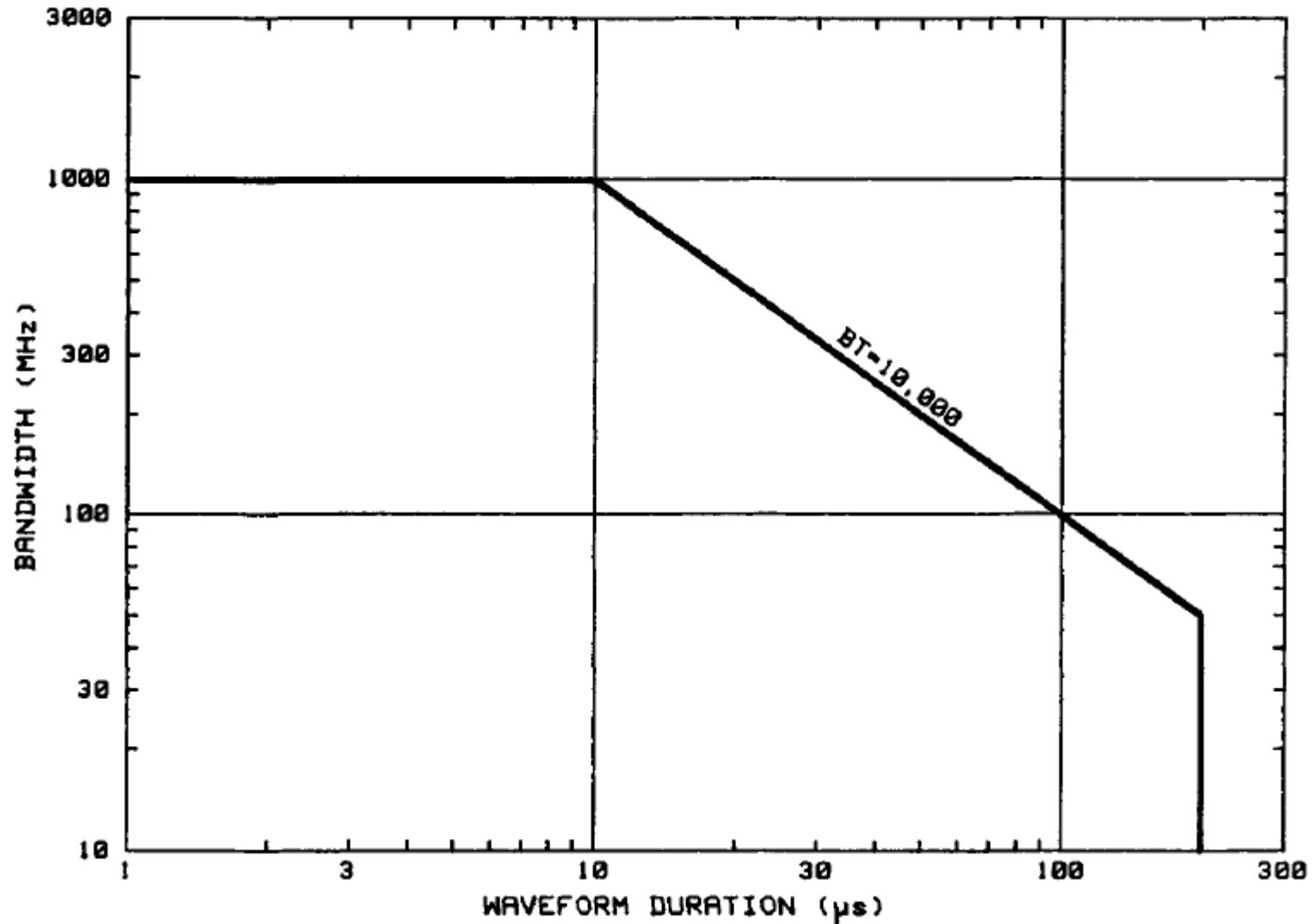

Chirp approximation and sidelobes

- Chirp autocorrelation
(matched filter output)

$$g(t) = \sqrt{\frac{B}{T}} \frac{\sin \left[\pi \frac{B}{T} (T - |t|) t \right]}{\pi \frac{B}{T} t}$$

- approximated with

$$g(t) \cong \sqrt{\frac{B}{T}} \frac{\sin [\pi B t]}{\pi \frac{B}{T} t} = \sqrt{B T} \operatorname{sinc} [\pi B t]$$

which is the Inverse Fourier Transform of
a rectangle in the frequency domain

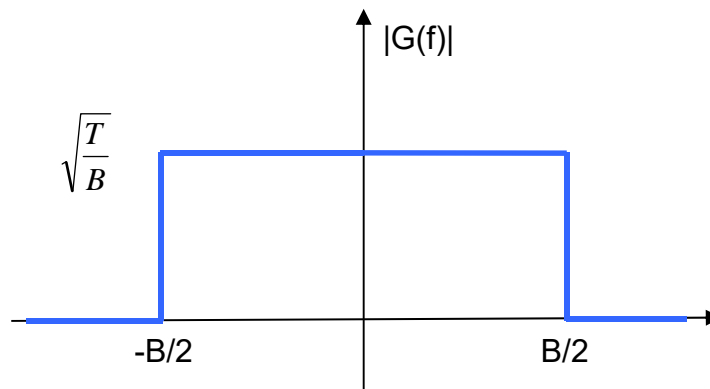

$$G(f) = \sqrt{\frac{T}{B}} \operatorname{rect}_B(f)$$

Distorsioni lineari (I)

Effetto delle distorsioni

- Il sistema reale sarà affetto da distorsioni (non sarà esattamente uguale a quello ideale): tutte le distorsioni di sistema possono essere sintetizzate in un filtro distorcente posto in cascata al filtro adattato ideale:

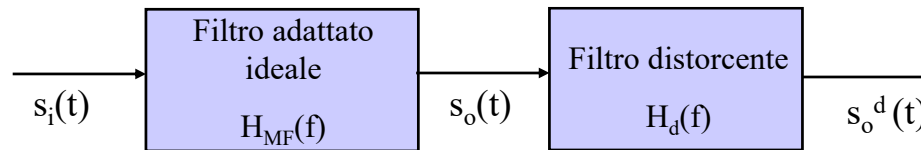

- Nell'ipotesi di piccole distorsioni la $H_d(f)$ può essere sviluppata in serie arrestandosi al primo termine

$$H_d(f) = A(f)e^{jB(f)} \rightarrow \begin{cases} A(f) = 1 + a_1 \cos(2\pi C_a f) \\ e^{jB(f)} = e^{jb_1 \sin(2\pi C_b f)} \cong 1 + jb_1 \sin(2\pi C_b f) \end{cases}$$

- a_1 : valore di picco della componente di ampiezza;
- b_1 : valore di picco della componente di fase;
- C_a : frequenza ripple di ampiezza;
- C_b : frequenza ripple di fase;

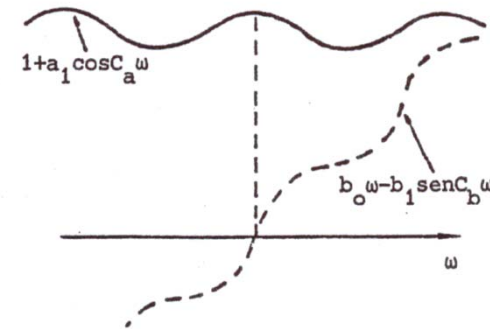

Distorsioni lineari (II)

- Il segnale di uscita distorto è dato da:

$$s_o^d(t) = s_o(t) + \frac{a_1}{2} s_o(t + C_a) + \frac{a_1}{2} s_o(t - C_a) \longrightarrow \text{effetto della distorsione di ampiezza;}$$

$$s_o^d(t) = s_o(t) + \frac{b_1}{2} s_o(t + C_b) - \frac{b_1}{2} s_o(t - C_b) \longrightarrow \text{effetto della distorsione di fase;}$$

**ECHI
APPAIATI**



L'utilizzo di filtri reali anziché ideali comporta la presenza di un disturbo additivo dato dagli echi appaiati: tanto maggiore è a_1 & b_1 tanto maggiore è l'ampiezza dell'eco, tanto minore è C_a & C_b (ripple lento) tanto più gli echi appaiati compaiono vicini al segnale utile \Rightarrow dalle specifiche di dinamica si può ricavare la massima distorsione ammissibile (valore massimo a_1 & b_1).

Frequency domain weighting (I)

- To control sidelobes of the compressed waveform, amplitude weighting with appropriate taper functions can be used

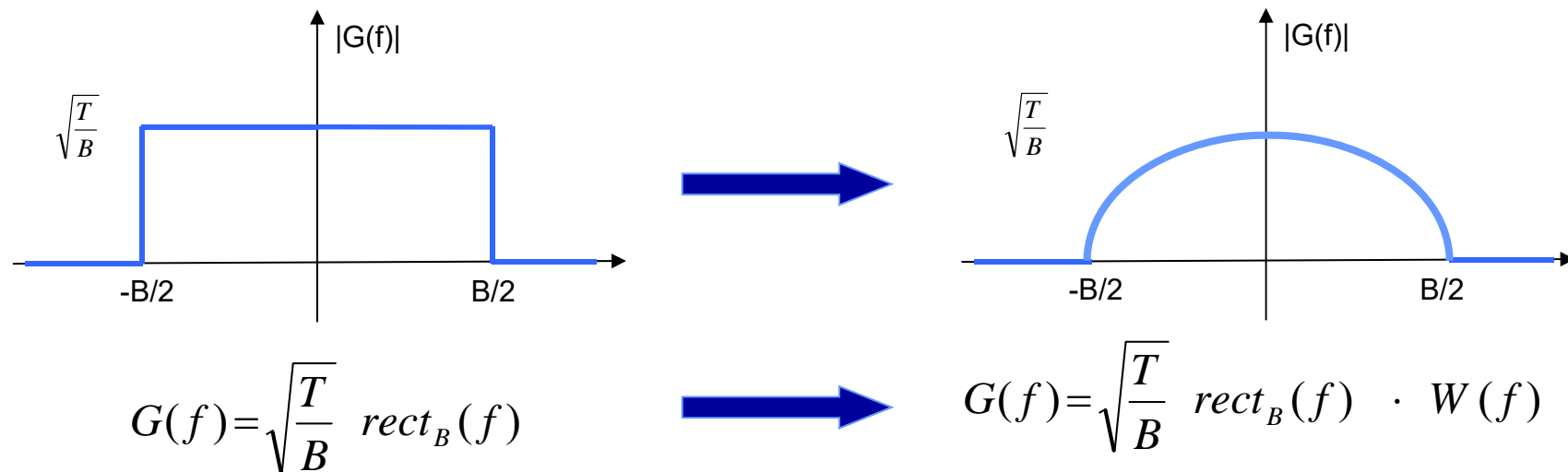

Taking the Inverse Fourier Transform, we have in time domain

$$g(t) \cong \sqrt{BT} \text{sinc} [\pi B t] \quad \longrightarrow \quad g(t) \cong \sqrt{BT} \text{sinc} [\pi B t] * w(t)$$

Frequency domain weighting (II)

- using appropriate taper function, allows to control sidelobes

For example

$$W(f) = (1 - k) + k \cos\left(\pi \frac{f}{B}\right)$$

$$w(t) = (1 - k) \delta(t) + \frac{k}{2} \delta\left(t - \frac{1}{2B}\right) + \frac{k}{2} \delta\left(t + \frac{1}{2B}\right)$$

Shifted replicas to remove sidelobes ...

$$g(t) \cong \sqrt{BT} \left\{ (1 - k) \operatorname{sinc} [\pi B t] + \frac{k}{2} \operatorname{sinc} \left[\pi B \left(t - \frac{1}{2B}\right) \right] + \frac{k}{2} \operatorname{sinc} \left[\pi B \left(t + \frac{1}{2B}\right) \right] \right\}$$

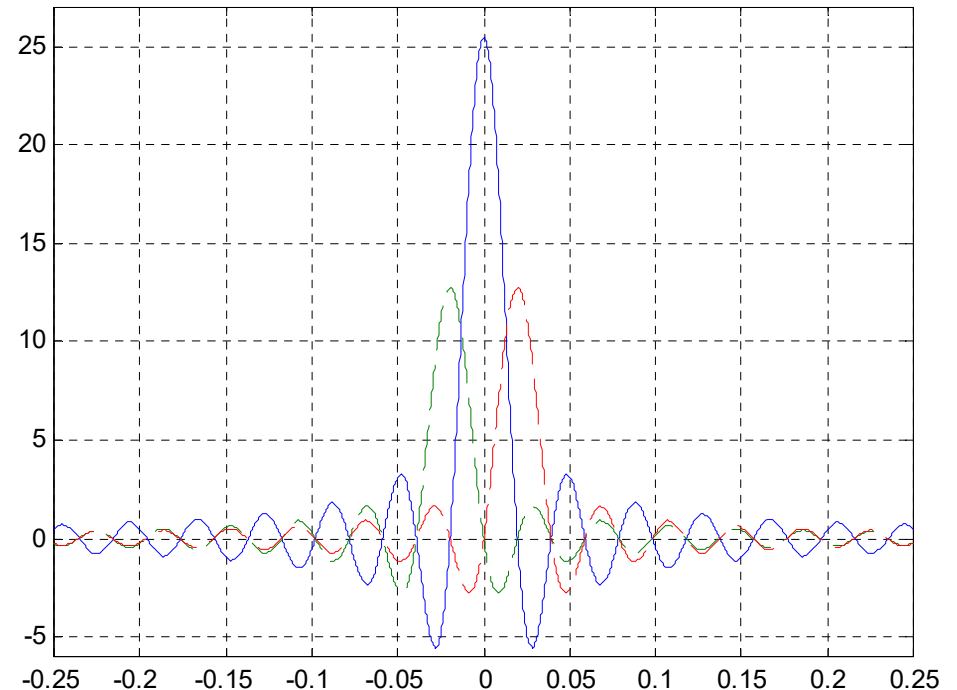

Analog vs. Digital domain operations

- usually compression is applied in the sampled domain
- Starting from an approximately rectangular chirp spectrum (sampled in frequency at $1/T$)

$$g(t_n) = \sum_{k=-\frac{(N-1)}{2}}^{\frac{(N-1)}{2}} e^{+j\frac{2\pi}{T}kt_n} = \frac{\sin\left[\frac{\pi}{T}(N-1)t_n\right]}{\sin\left[\frac{\pi}{T}t_n\right]}$$

Zeros of NUM: $t_n = \frac{kT}{N-1}$

Zeros of DEN: $t_n = kT$

which is the Inverse Fourier Transform of a rectangle in the frequency domain

$$g(t_n) = \sum_{k=-\frac{(N-1)}{2}}^{\frac{(N-1)}{2}} w_k e^{+j\frac{2\pi}{T}kt_n} \quad \text{with} \quad w_k = W\left(\frac{k}{T}\right)$$

Compressed waveform quality parameters

● **Side Lobe Level**
$$\text{SLL} = \frac{\text{Amplitude of the highest Side Lobe}}{\text{Main Beam Peak}}$$
Side Lobe Ratio
$$\text{SLR} = (\text{SLL})^{-1}$$

$w_k \rightarrow$ taper coefficients



Generally achieved at the expense of:

● **Efficiency**

$$\eta = \frac{\left(\sum_{k=0}^{N-1} w_k \right)^2}{N \sum_{k=0}^{N-1} w_k^2}$$

● **3 dB resolution**

Taylor (1953):

- Symmetric weights yield lower sidelobes
- The sidelobe decay depends on the discontinuity in the aperture distribution and in its derivatives.
- A weight distribution with non-zero external elements (pedestal) is more efficient

Common used taper functions

	Efficiency η	PSL (dB)	Main lobe width (w.r.t) $1/B$.
Uniform	1	-13.3	0.89
Cosine	0.81	-23	1.19
Cosine squared (Hanning)	0.67	-32	1.44
Cosine squared on 10 dB pedestal	0.88	-26	1.08
Cosine squared on 20 dB pedestal	0.75	-40	1.28
Hamming	0.73	-43	1.30
Dolph Chebyshev	0.72	-50	1.33
Dolph Chebyshev	0.66	-60	1.44
Taylor $n\text{-bar}=3$	0.9	-26	1.05
Taylor $n\text{-bar}=5$	0.8	-36	1.18
Taylor $n\text{-bar}=8$	0.73	-46	1.30

Triangle (Bartlett) Window

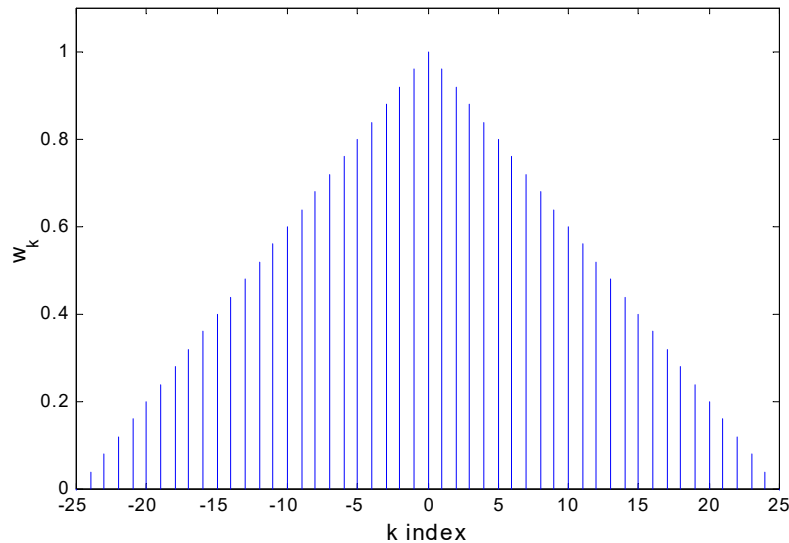

$$w_k = 1 - \frac{|k|}{(N-1)/2} \quad k = -\frac{N-1}{2}, \dots, -1, 0, 1, \dots, \frac{N-1}{2}$$

$$g(t_n) = \frac{2}{N} \left[\frac{\sin\left[\frac{\pi N}{T} \frac{t_n}{2}\right]}{\sin\left[\frac{\pi}{T} t_n\right]} \right]^2$$

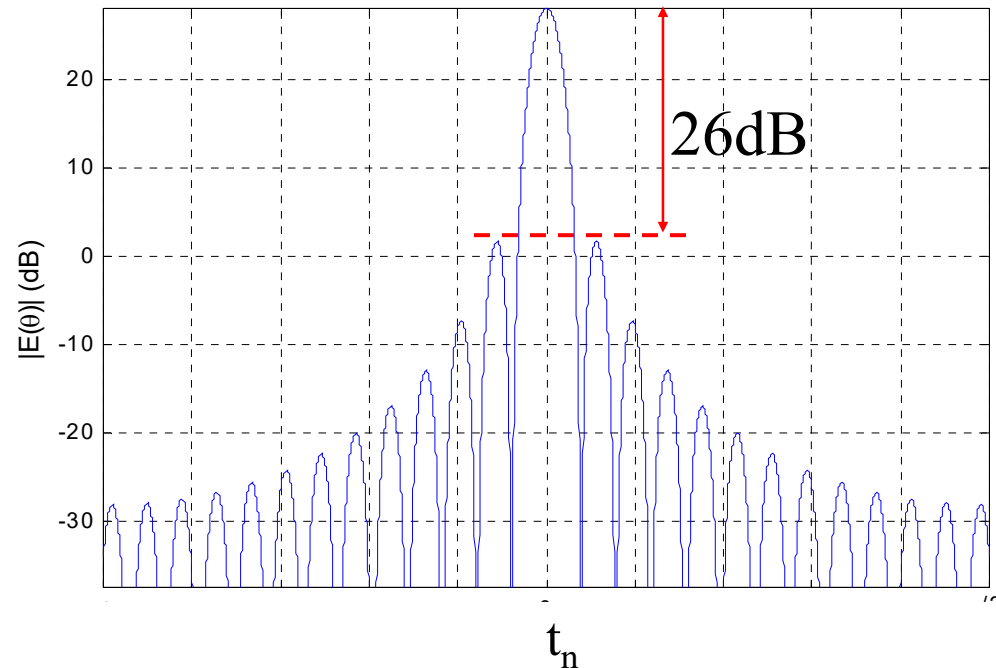

- Main Beam width (between zero crossing) is twice that of the uniform window
- Zeros of order 2 in the Fourier Transform
- $SLR \approx 26\text{dB} = 2 * 13\text{dB}$
- Decay $SL \propto 1/x^2$ (-12dB/oct)
(discontinuity in the first derivative)

$\cos^\alpha(x)$ Windows

$$w_k = \cos^\alpha \left[\frac{k}{N-1} \pi \right] \quad k = -\frac{N-1}{2}, \dots, -1, 0, 1, \dots, \frac{N-1}{2}$$

As α increases, the windows become smoother and the pattern shows increased SLR and faster falloff of the SL, but with an increase width of the ML.

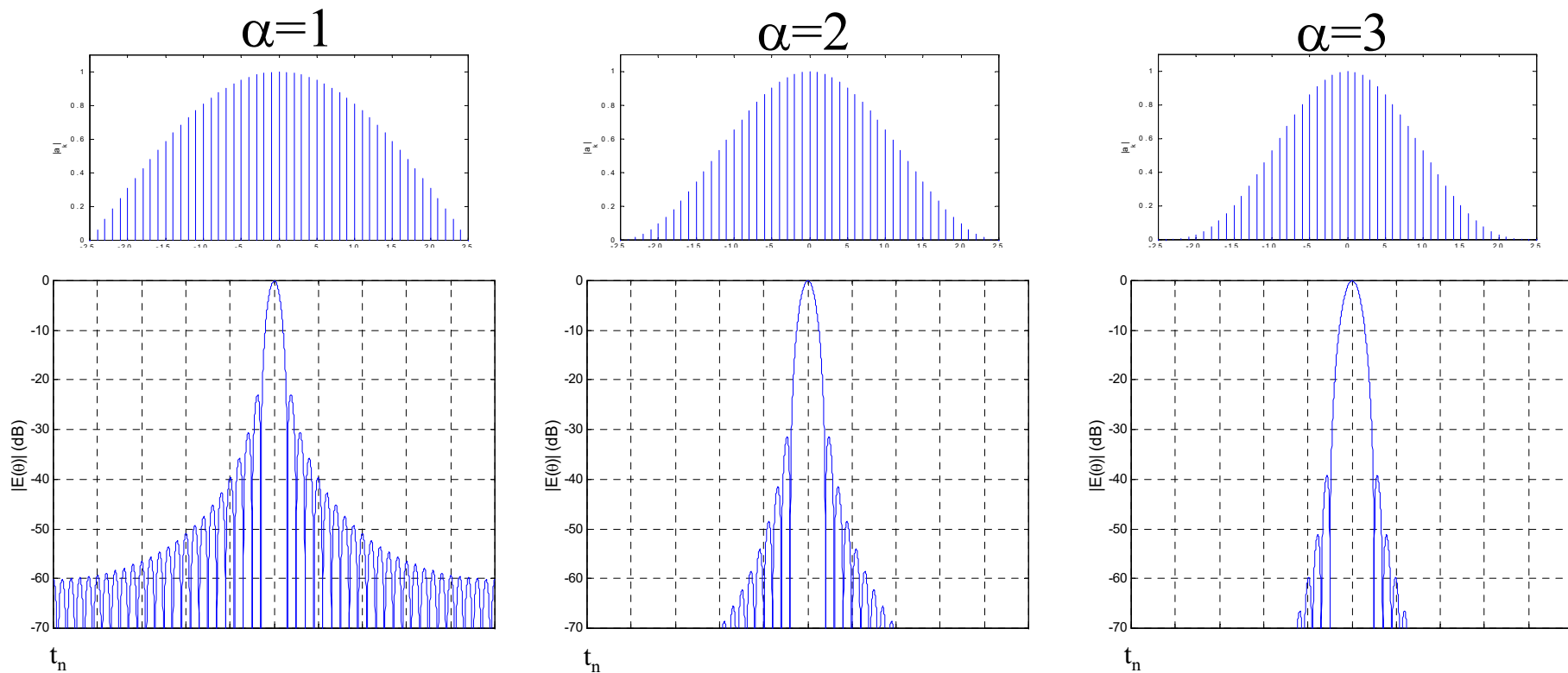

$\cos^\alpha(x)$ Windows \rightarrow Hanning Window ($\alpha=2$)

$$w_k = \cos^2\left[\frac{k}{N-1}\pi\right] = \frac{1}{2}\left[1 + \cos\left[\frac{2k}{N-1}\pi\right]\right] = \frac{1}{2} + \frac{1}{2}\cos\left[\frac{2k}{N-1}\pi\right] \quad k = -\frac{N-1}{2}, \dots, -1, 0, 1, \dots, \frac{N-1}{2}$$

$$g(t_n) = \left\{ \frac{1}{2}D(x) + \frac{1}{4}\left[D\left(x + \frac{\pi}{N}\right) + D\left(x - \frac{\pi}{N}\right) \right] \right\}$$

$$D(x) = \frac{\sin\left[\frac{\pi}{T}Nt_n\right]}{\sin\left[\frac{\pi}{T}t_n\right]}$$

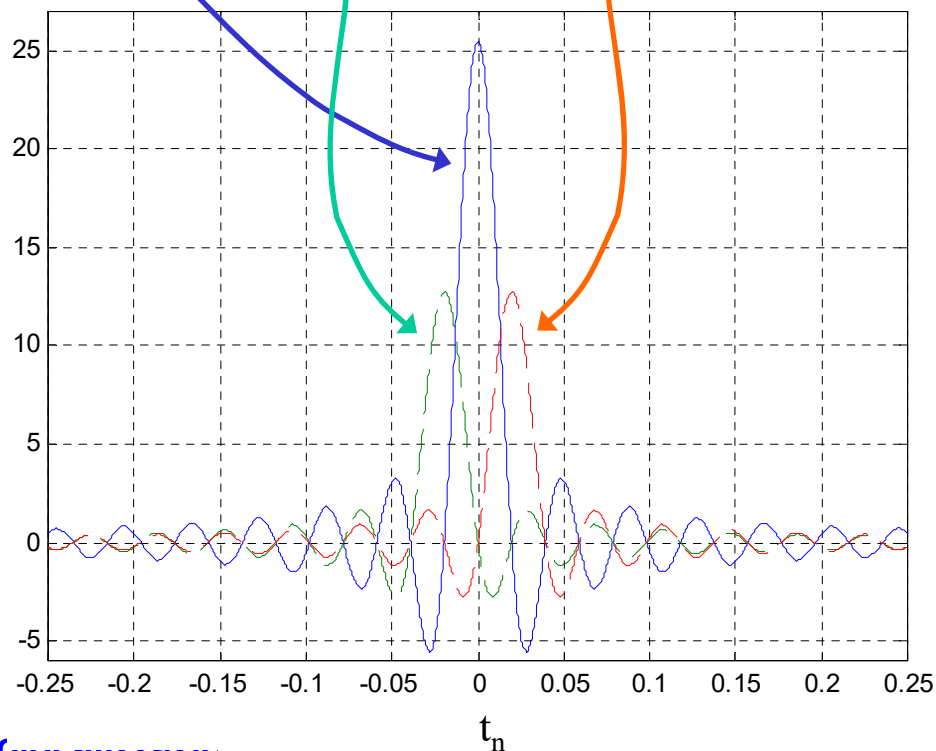

$\cos^\alpha(x)$ Windows \rightarrow Hanning Window ($\alpha=2$)

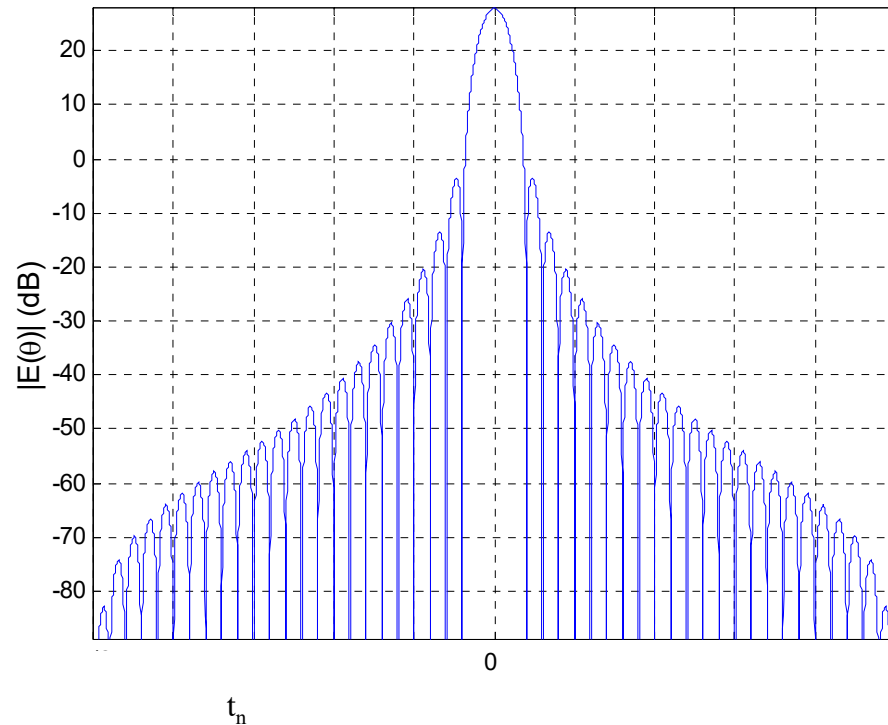

- It does not require extra memory and is controlled by a single parameter.
- Wide enlargement of the main lobe
- Low efficiency: $\eta=0.67$
- SLR=32dB
- SL Decay $\propto 1/x^3$ (-18dB/oct)
(discontinuity in the second derivative)

Hamming Window (1/2)

The Hamming weights are a modified version of the Hanning weights:

$$\text{Hanning} \left\{ \begin{array}{l} w_k = \frac{1}{2} + \frac{1}{2} \cos \left[\frac{2k}{N-1} \pi \right] \quad k = -\frac{N-1}{2}, \dots, -1, 0, 1, \dots, \frac{N-1}{2} \\ g(t_n) = \left\{ \frac{1}{2} D(x) + \frac{1}{4} \left[D\left(x + \frac{\pi}{N}\right) + D\left(x - \frac{\pi}{N}\right) \right] \right\} \end{array} \right.$$

It is obtained by modifying the coefficients of the combination of D(x) functions to achieve a better SL cancellation

$$\left\{ \begin{array}{l} w_k = \gamma + (1-\gamma) \cos \left[\frac{2k}{N-1} \pi \right] \quad k = -\frac{N-1}{2}, \dots, -1, 0, 1, \dots, \frac{N-1}{2} \\ g(t_n) = \left\{ \gamma D(x) + \frac{1}{2} (1-\gamma) \left[D\left(x + \frac{\pi}{N}\right) + D\left(x - \frac{\pi}{N}\right) \right] \right\} \end{array} \right.$$

Cancellation of the first sidelobe is for $\gamma=0.543478261$. in practice, it is used

$$\gamma=0.54: \text{Hamming} \left\{ \begin{array}{l} w_k = 0.54 + 0.46 \cos \left[\frac{2k}{N-1} \pi \right] \quad k = -\frac{N-1}{2}, \dots, -1, 0, 1, \dots, \frac{N-1}{2} \\ g(t_n) = \left\{ 0.54 D(x) + \frac{1}{2} 0.46 \left[D\left(x + \frac{\pi}{N}\right) + D\left(x - \frac{\pi}{N}\right) \right] \right\} \end{array} \right.$$

Hamming Window (2/2)

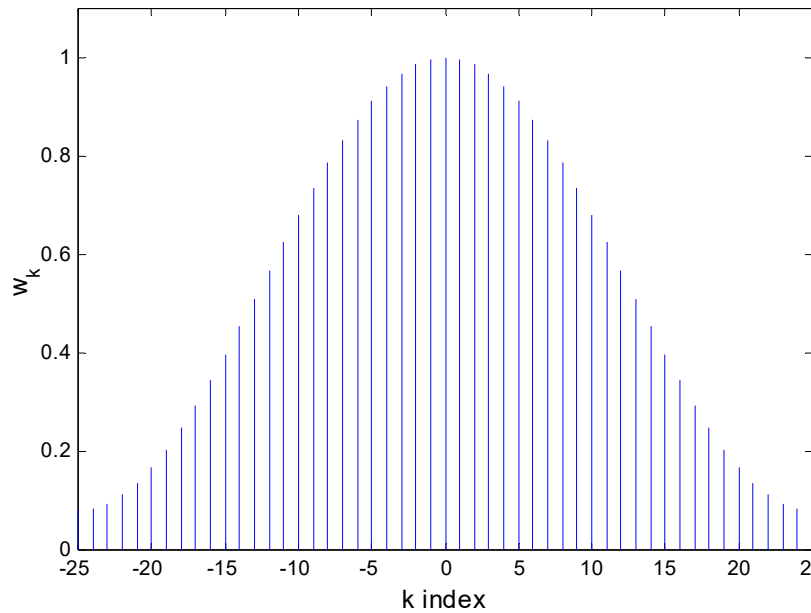

- SLR=43dB
- SL Decay $\propto 1/x$ (-6dB/oct)
(discontinuity at the extremes)

- large attenuation of the first SL of the original compressed waveform
- Better efficiency than Hanning: $\eta=0.73$

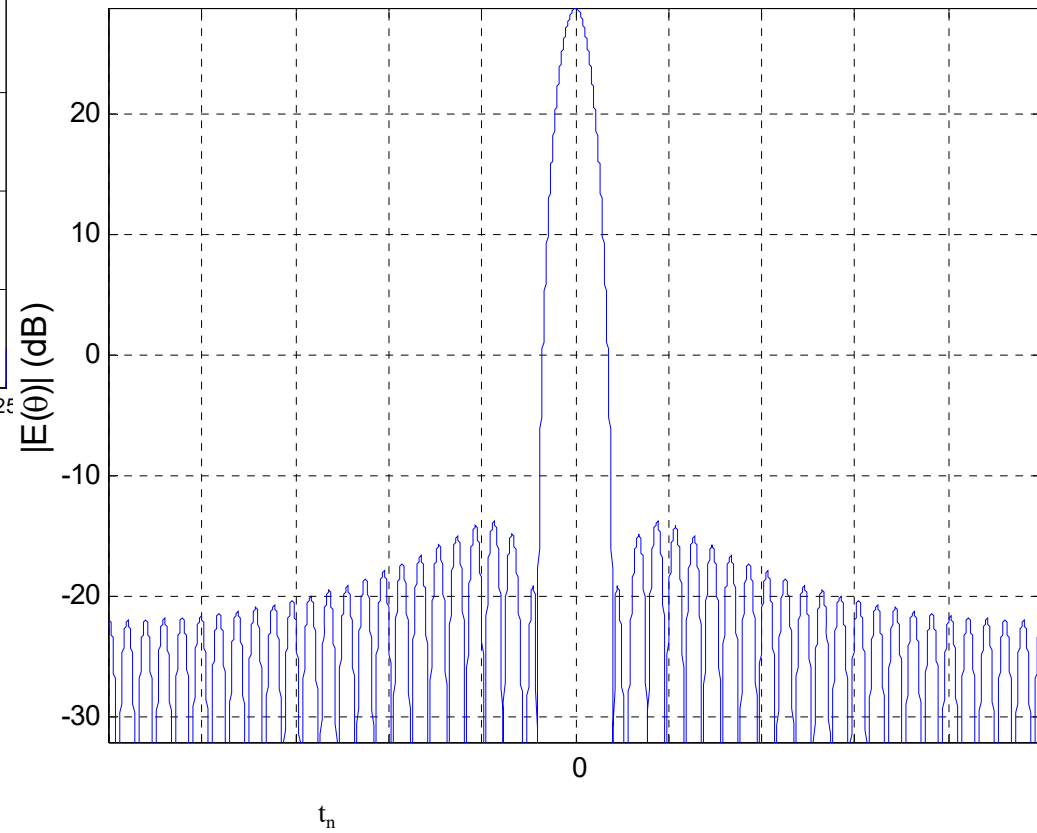

Blackman Windows

- Hanning and Hamming taper functions belong to the “raised cosine” family
- Both are special cases of the Blackman windows (windows function of $(N+1)/2$ parameters) with only γ_0 and γ_1 non-zero coefficients :

$$w_k = \sum_{m=0}^{(N-1)/2} \gamma_m \cos\left(\frac{2\pi}{N-1} mk\right) \quad \sum_{m=0}^{(N-1)/2} \gamma_m = 1 \quad k = -\frac{N-1}{2}, \dots, -1, 0, 1, \dots, \frac{N-1}{2}$$

Difficulties with the family of windows:

- The choice of parameters to achieve the desired waveform characteristics is difficult (complex inversion)
- Often the characteristics are not adequate in terms of resolution and efficiency.

Dolph-Chebyshev Window (1/3)

It provides the maximal resolution for assigned sidelobe (constant) level!

The design is based on the properties of the **Chebyshev polynomials** :

$$T_n(u) = \begin{cases} (-1)^n \cosh(n \cosh^{-1}|u|) & u < -1 \\ \cos(n \cos^{-1}u) & |u| \leq 1 \\ \cosh(n \cosh^{-1}u) & u > 1 \end{cases}$$

Properties:

- $T_n(u) = 2uT_{n-1}(u) - T_{n-2}(u)$
- Zeros in $|u| \leq 1, u_p = \cos\left[(2p-1)\frac{\pi}{2n}\right] \quad p = 1, \dots, n$
- Maxima and minima in $u_k = \cos\left[\frac{k\pi}{n}\right] \quad k = 1, \dots, n-1$
- Also $T_n(u_k) = \pm 1$

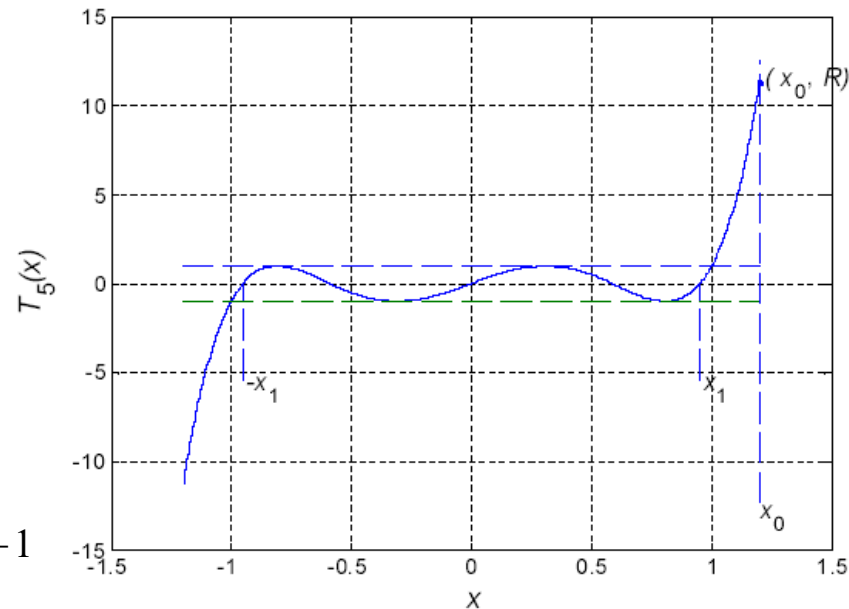

H.L. Van Trees, Optimum Array Processing, Wiley

For a window of N elements, a polynomial with order $n=N-1$ is used ($N-1$ zeros).

The oscillating part of the polynomial is used for the sidelobes, while the main lobe is mapped in the region $x > 1$.

Radiotecnica e Radiolocalizzazione

Dolph-Chebyshev Window (2/3)

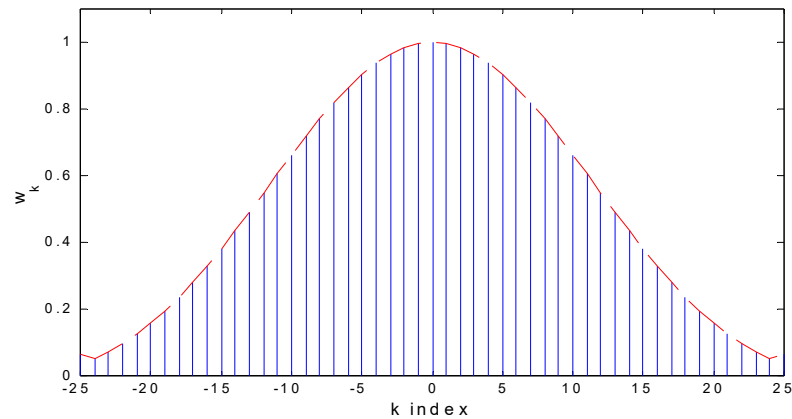

SLR=50dB

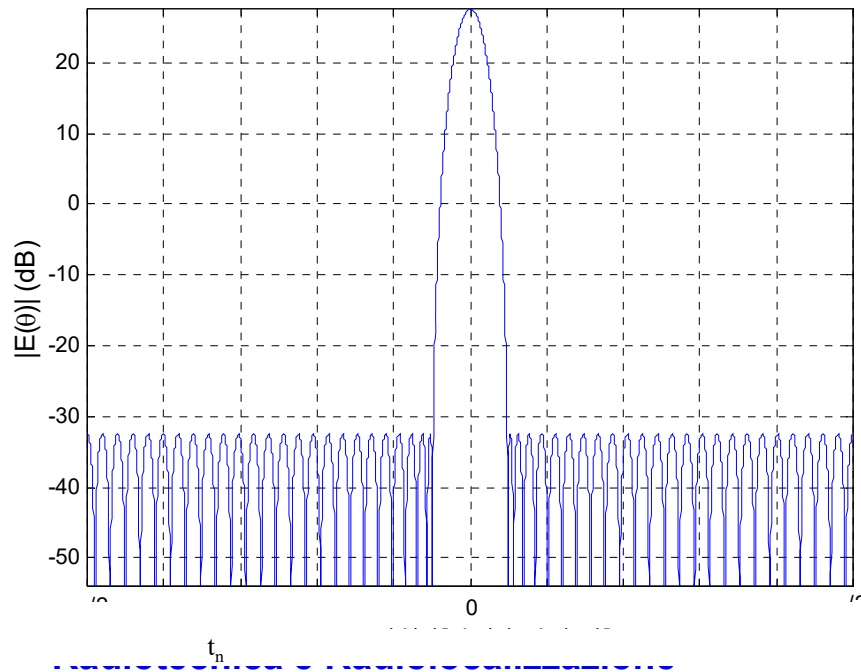
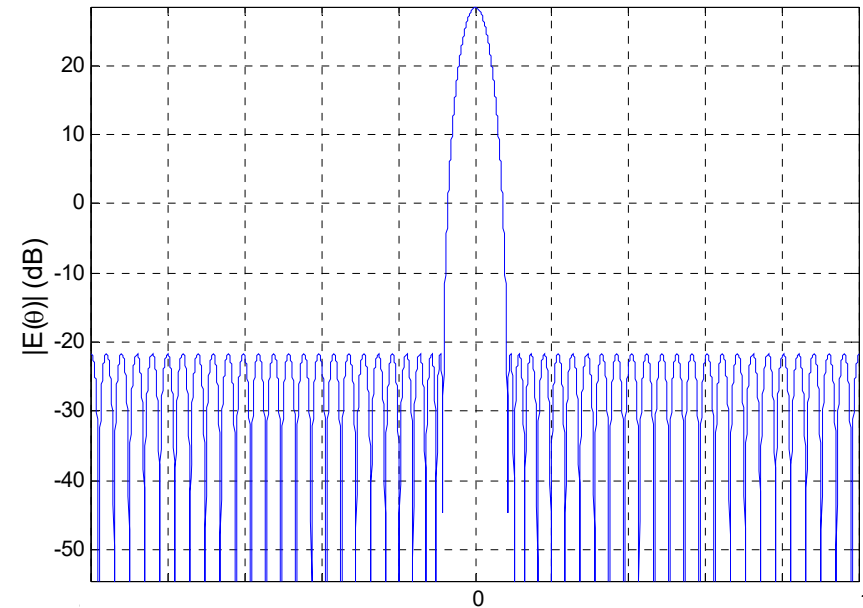

SLR=60dB

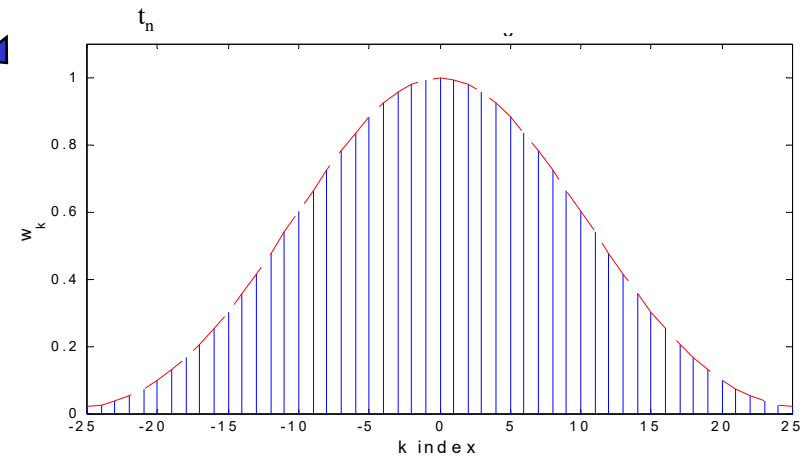

Dolph-Chebyshev Window (3/3)

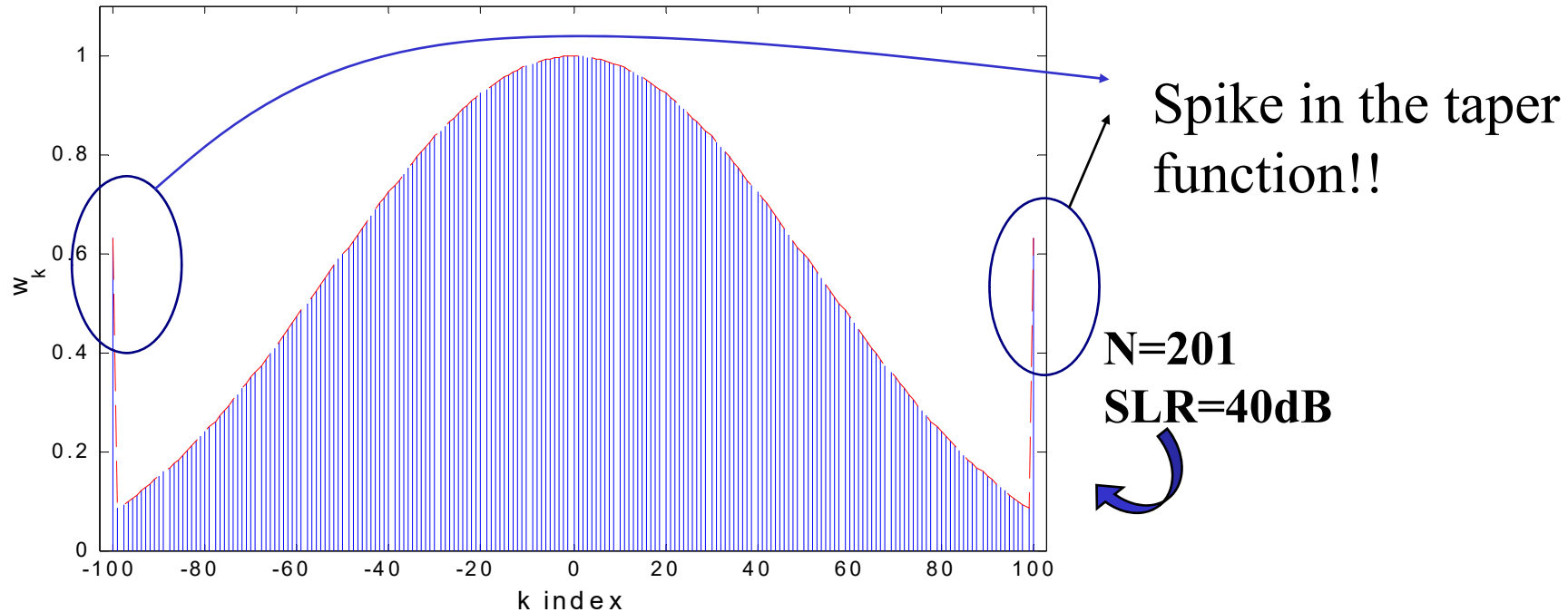

For this reason, such taper function is not used in practice.
The Taylor taper function is studied to solve such undesired feature, while keeping the nice properties of the Dolph-Chebyshev solution.

Taylor n-bar Window (1/4)

This is a trade-off between Dolph-Chebyshev taper function with constant RSL and the uniform weights with $1/x$ sidelobe decay.

Starting point

$$\begin{cases} F(u) = \cosh\left[\pi\sqrt{A^2 - u^2}\right] & u \leq A \\ F(u) = \cos\left[\pi\sqrt{u^2 - A^2}\right] & u \geq A \end{cases}$$

- $u = 2x/\pi$
- Pattern with constant level sidelobes
- There is a transition in the main lobe at $u=A$ between the hyperbolic function and the trigonometric function
- Zeros at $\rightarrow z_n = \pm\sqrt{A^2 + (n-1/2)^2}$
- $SLR = F(0) = (1/\pi)\cosh A$

Strategy

Using this ideal pattern, there are still spikes at the window borders \rightarrow an approximate pattern is used where:

- The first \bar{n} sidelobes are maintained at a constant level
- The pattern zeros are moved to achieve a $1/u$ behavior in the sidelobe level region far from the main beam

Taylor n-bar Window (2/4)

New zeros:

$$\begin{cases} z_n = \pm \sigma \sqrt{A^2 + (n-1/2)^2} & 1 \leq n \leq \bar{n} \\ z_n = \pm n & n \geq \bar{n} \end{cases} \quad \sigma = \frac{\bar{n}}{\sqrt{A^2 + (\bar{n} - 1/2)^2}}$$

$$F(u) = \frac{\sin \pi u}{\pi u} \prod_{n=1}^{\bar{n}-1} \frac{1 - \left(\frac{u}{z_n}\right)^2}{1 - \left(\frac{u}{n}\right)^2} \quad \xrightarrow{\text{Inversion}} \quad w_k = \left[1 + 2 \sum_{n=1}^{\bar{n}-1} F(n, A, \bar{n}) \cos\left(n\pi \frac{2k}{(N-1)}\right) \right] / w_{MAX}$$

with $F(n, A, \bar{n}) = \frac{[(\bar{n}-1)!]^2}{(\bar{n}-1+n)! (\bar{n}-1-n)!} \prod_{m=1}^{\bar{n}-1} \left[1 - \left(\frac{n}{z_m}\right)^2 \right]$

$$k = -\frac{N-1}{2}, \dots, -1, 0, 1, \dots, \frac{N-1}{2}$$

Taylor n-bar Window (3/4)

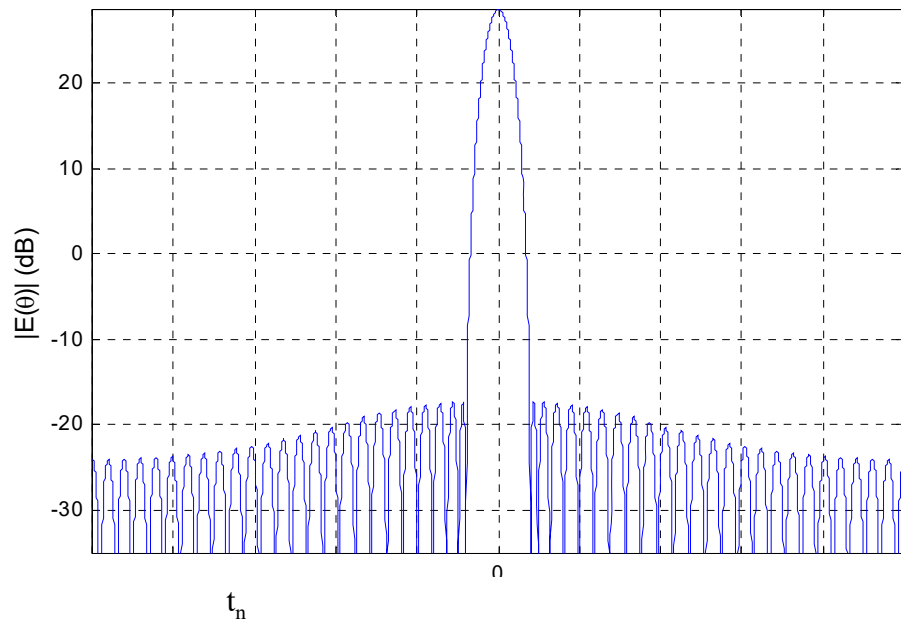
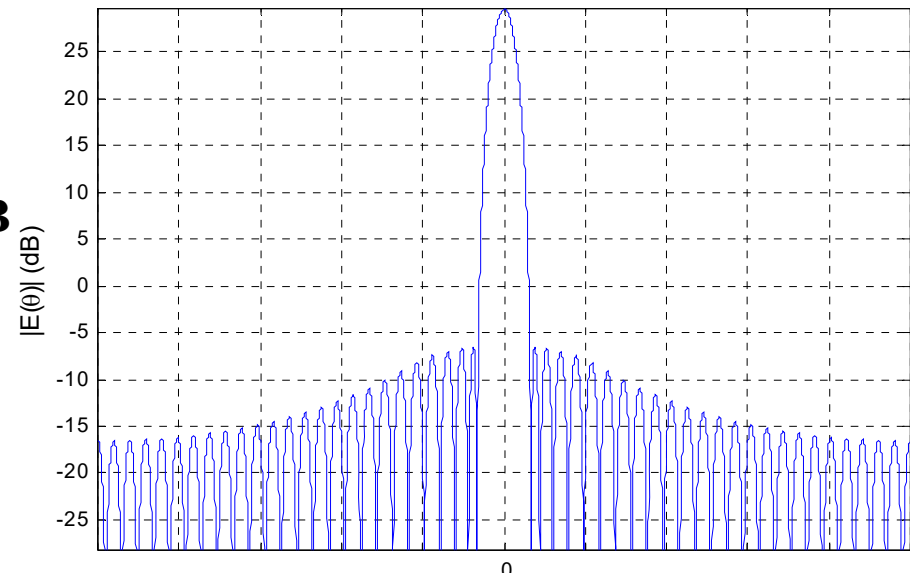
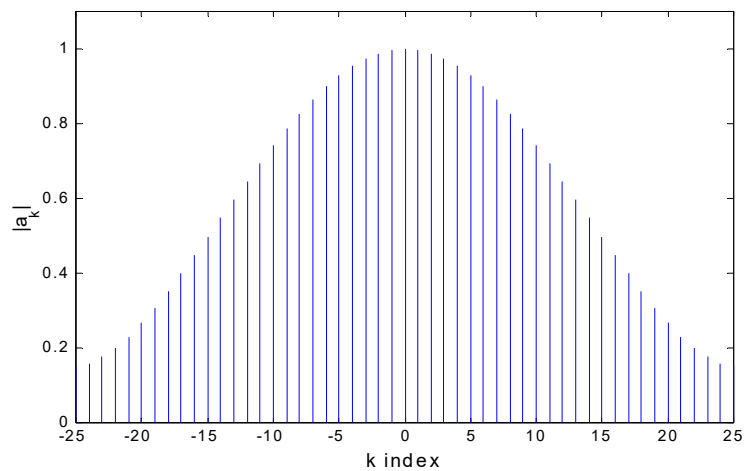

$\bar{n} = 8$
SLR=46dB

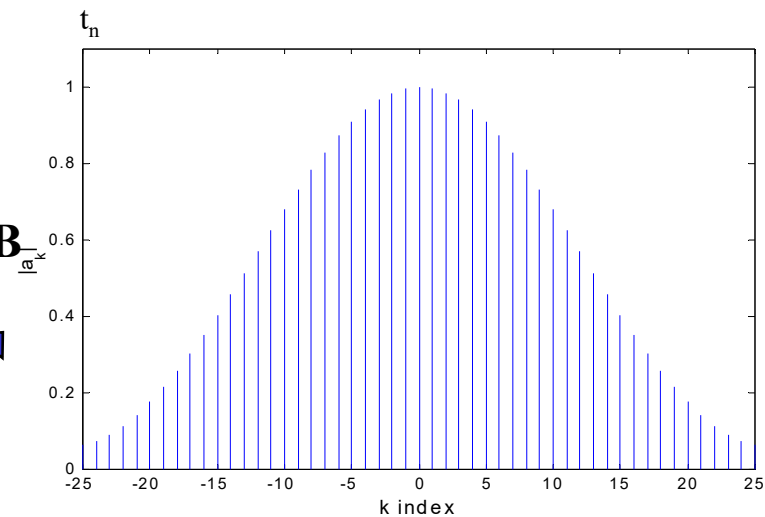

Taylor n-bar Window (4/4)

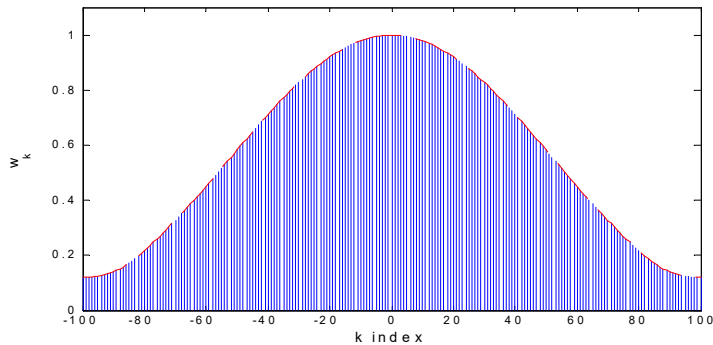

$\bar{n} = 10$
 $N = 201$
 $SLR = 40\text{dB}$



No spikes!

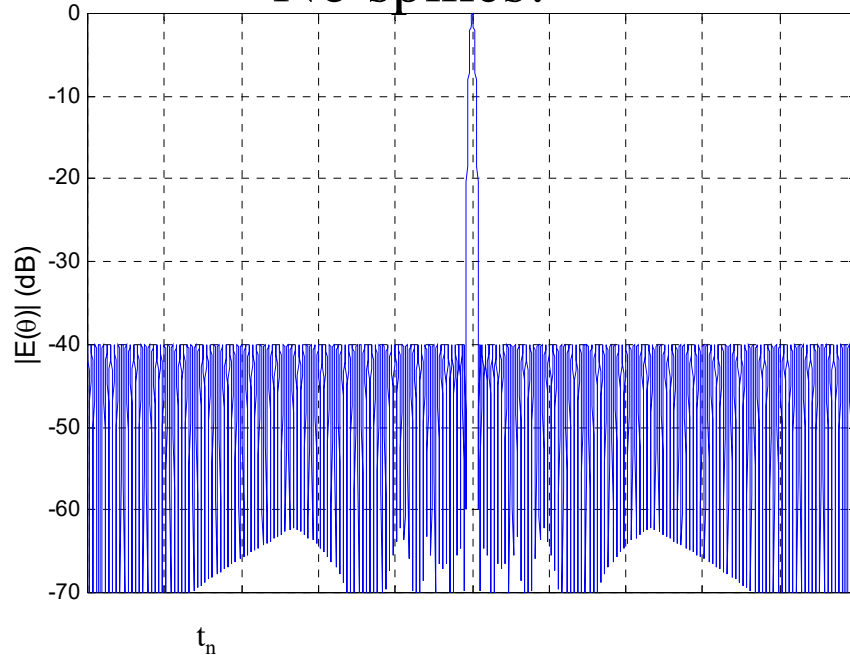

**Chebyshev
 pattern
 -40dB**

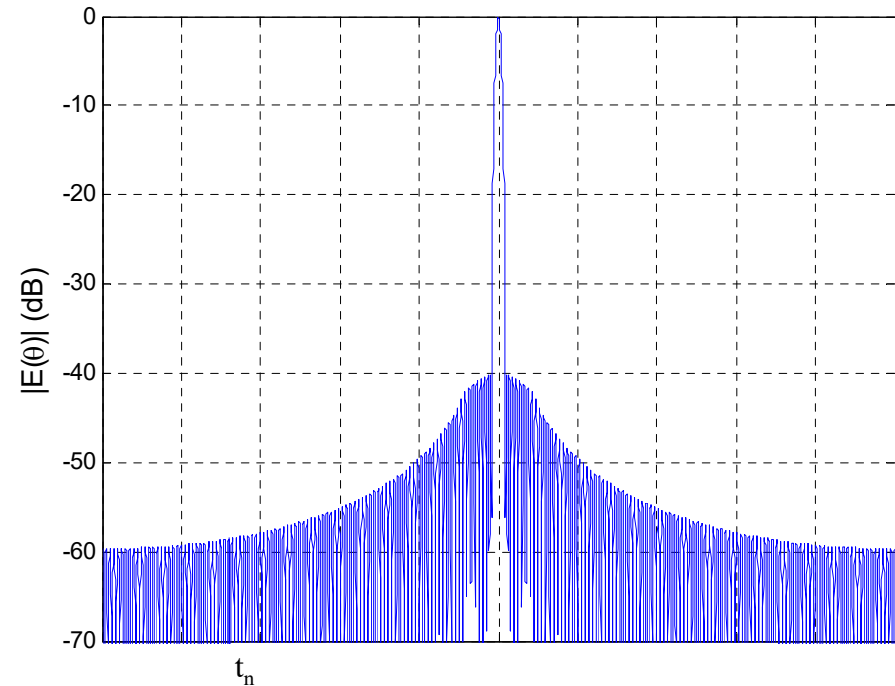

- Good approximation for the first SL
- SL asymptotic decay $\propto 1/x$
- Main beam widening
- n cannot be too small for an assigned SLR, but large n values yield implementation problems

Rete di Taylor: coefficienti

$$4. \quad w_{\text{Toy}}(t) = \sum_{m=-\bar{n}}^{\bar{n}} F_m w_0\left(t - \frac{m}{B}\right)$$

where

$$F_0 = 1, F_m = 0 \text{ for } |m| \geq \bar{n}$$

and

$$F_m = E_m$$

TAYLOR WEIGHTING:

$$W_{\text{Toy}}(f) =$$

$$W_0(f) \left[1 + 2 \sum_{m=1}^{\bar{n}-1} F_m \cos 2\pi m \frac{f}{B} \right]$$

(REFS. 39,42,43)

TABLE 10.9 Taylor Coefficients F_m *

Design sidelobe ratio, dB	-30	-35	-40	-40	-45	-45	-50
\bar{n}	4	5	6	8	8	10	10
Main lobe width, -3 dB	1.13/B	1.19/B	1.25/B	1.25/B	1.31/B	1.31/B	1.36/B
F_1	0.292656	0.344350	0.389116	0.387560	0.428251	0.426796	0.462719
F_2	-0.157838(-1)	-0.151949(-1)	-0.945245(-2)	-0.954603(-2)	0.208399(-3)	-0.682067(-4)	0.126816(-1)
F_3	0.218104(-2)	0.427831(-2)	0.488172(-2)	0.470359(-2)	0.427022(-2)	0.420099(-2)	0.302744(-2)
F_4		-0.734551(-3)	-0.161019(-2)	-0.135350(-2)	-0.193234(-2)	-0.179997(-2)	-0.178566(-2)
F_5			0.347037(-3)	0.332979(-4)	0.740559(-3)	0.569438(-3)	0.884107(-3)
F_6				0.357716(-3)	-0.198534(-3)	0.380378(-5)	-0.382432(-3)
F_7				-0.290474(-3)	0.339759(-5)	-0.224597(-3)	0.121447(-3)
F_8						0.246265(-3)	-0.417574(-5)
F_9						-0.153486(-3)	-0.249574(-4)

* $F_0 = 1$; $F_{-m} = F_m$; floating decimal notation: $-0.945245(-2) = -0.00945245$.

Confronto reti di pesatura

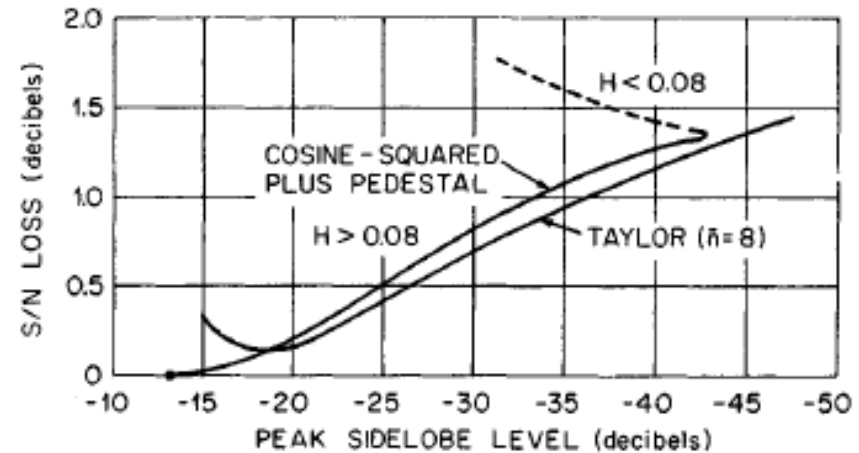
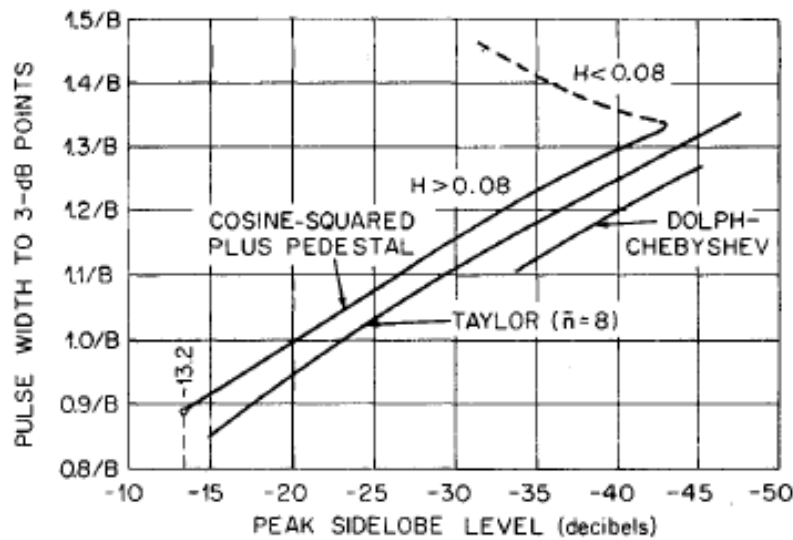
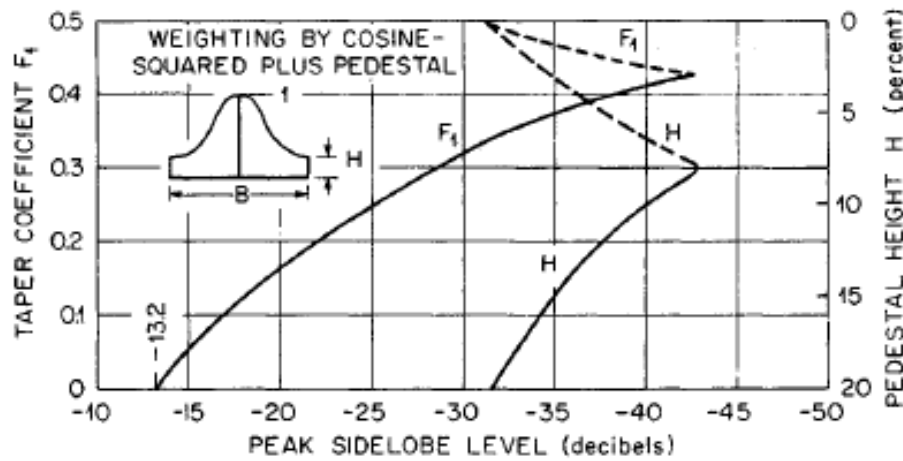

FIG. 10.16 (a) Taper coefficient and pedestal height versus peak sidelobe level. (b) Compressed-pulse width versus peak sidelobe level. (c) SNR loss versus peak sidelobe level.

Chirp approximation and sidelobes (II)

▪ Side Lobe di Fresnel

$$S.L.F. |_{dB} = 20 \log(BT) + 3$$

Porzione trascurata
nell'approx
rettangolare

Importante per bassi
rapporti di
compressione

Limita la possibilità di
abbassare i lobi laterali
tramite pesatura

