Forme d'onda con modulazione di fase

Pierfrancesco Lombardo

Forme d'onda con codifica di fase

$$s_0(t) = \frac{1}{\sqrt{N\tau_p}} \sum_{n=0}^{N-1} s_{0n}(t - n \cdot \tau_p)$$

$$s_{0n}(t) = e^{j\phi_n} \text{rect}_{\tau_p} \left(t - \frac{\tau_p}{2} \right) = \begin{cases} e^{j\phi_n}, & 0 \leq t \leq \tau_p \\ 0, & \text{altrove} \end{cases}$$

Barker
Frank
P3 e P4
P(n,k)

- **Codici bi-fase:**

- facili da implementare
- permettono buon controllo dei lobi laterali
- non forte tolleranza alla frequenza Doppler

- **Codici poli-fase:**

- tendono ad avere migliore tolleranza alla frequenza Doppler
- tendono a permettere un miglior controllo dei lobi laterali

Codici Binari

- La fase della portante ad RF commuta fra due valori di fase distanti di 180°

Può essere descritta usando sequenze di +1 e -1:

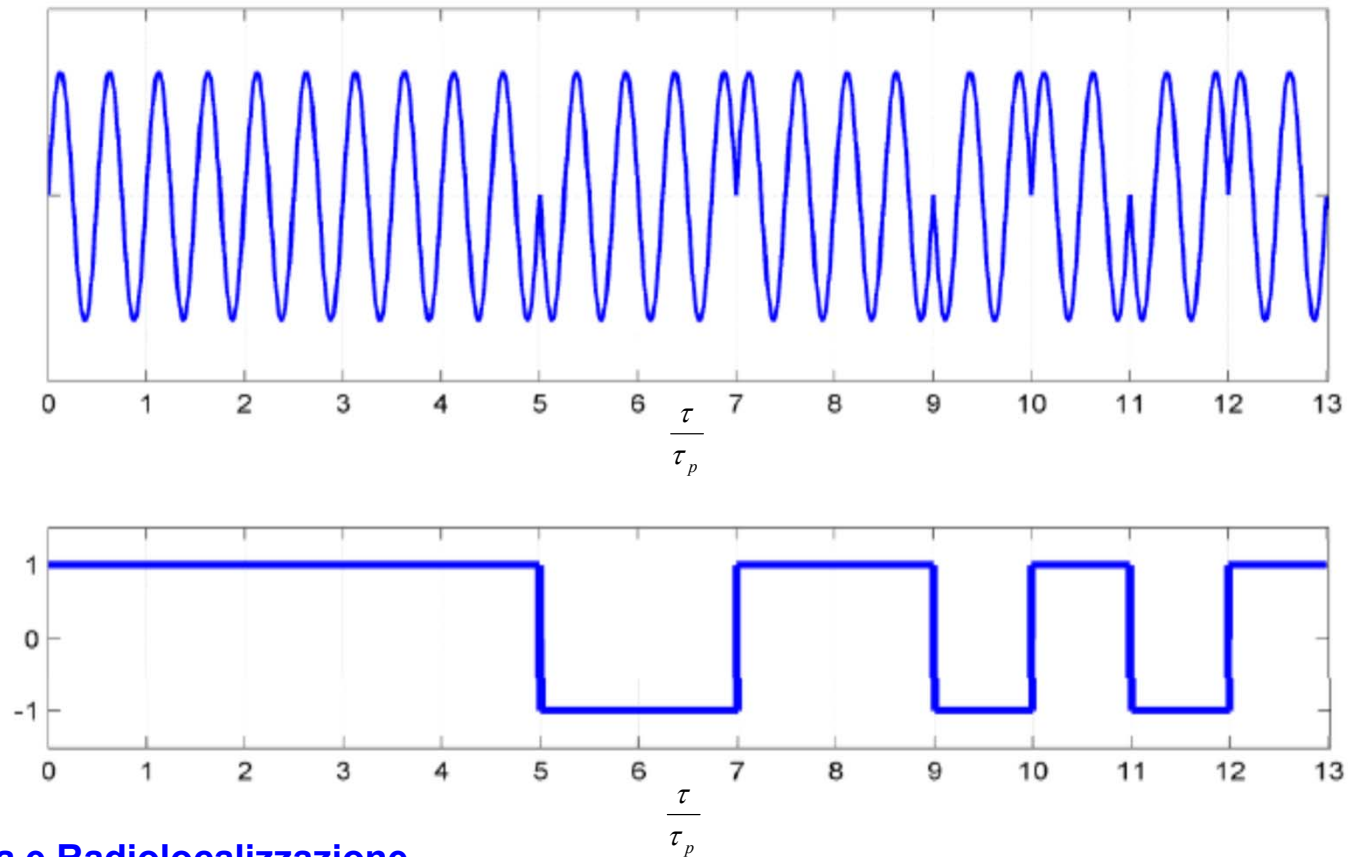

Codici di Barker

Sono codici binari di lunghezza N, caratterizzati da Funzione di AutoCorrelazione (ACF) con lobi laterali in modulo $\leq 1/N$

- Esistono solo poche sequenze con queste caratteristiche:

Lunghezza N	codice	PSR (dB)	ISLR (dB)
2	+ -	6,0	3,0
2	++	6,0	3,0
3	++-	9,5	6,5
3	+ - +	9,5	6,5
4	++-+	12,0	6,0
4	+++ -	12,0	6,0
5	+++ - +	14,0	8,0
7	+++ - - + -	16,9	9,1
11	+++ - - - + - - + -	20,8	10,8
13	+++++ - - + - - + - +	22,3	11,5

Calcolo ACF del codice di Barker da 7

Table 8.3 The Autocorrelation Sequence of a Barker Code of Length 7

$\{u_n\}$		+	+	+	-	-	+	-						
$\{u_{N-n+1}^*\}$														
-		-	-	-	+	+	-	+						
+			+	+	+	-	-	+	-					
-				-	-	-	+	+	-	+				
-					-	-	-	+	+	-	+			
+						+	+	+	-	-	+	-		
+							+	+	+	-	-	+	-	
+								+	+	+	-	-	+	-
Output sequence		-1	0	-1	0	-1	0	+7	0	-1	0	-1	0	-1

Da N. Levanon, "Radar Principles"

ACF del codice di Barker da 13

Rispetto ad impulso non modulato τ_p :

- Energia trasmessa $BT=n=13$ volte superiore
- risoluzione in tempo uguale
- risoluzione in Doppler $BT=n=13$ volte superiore
- (zona cieca $BT=n=13$ volte più larga)

Rispetto ad impulso non modulato $T=n\tau_p$:

- Energia trasmessa uguale
- risoluzione in tempo $BT=n=13$ volte migliore
- risoluzione in Doppler uguale
- (zona cieca uguale)

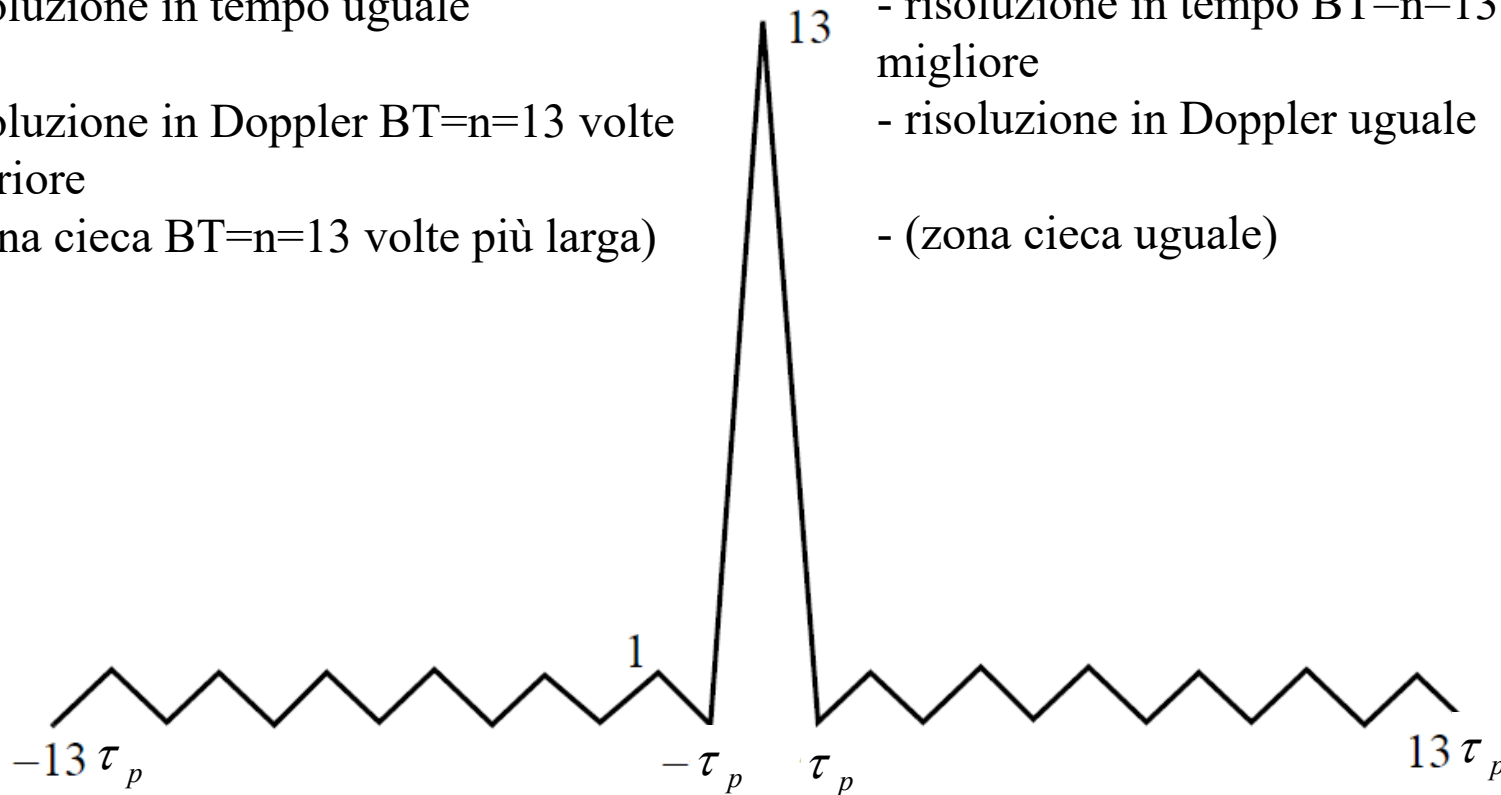

Codici di Barker innestati

- Si possono innestare codici di barker fra loro:
- Esempio di ACF per combinazione di Barker 13 con Baker 3

11111-1-111-11-11 11111-1-111-11-11 -1-1-1-1-111-1-11-11-1

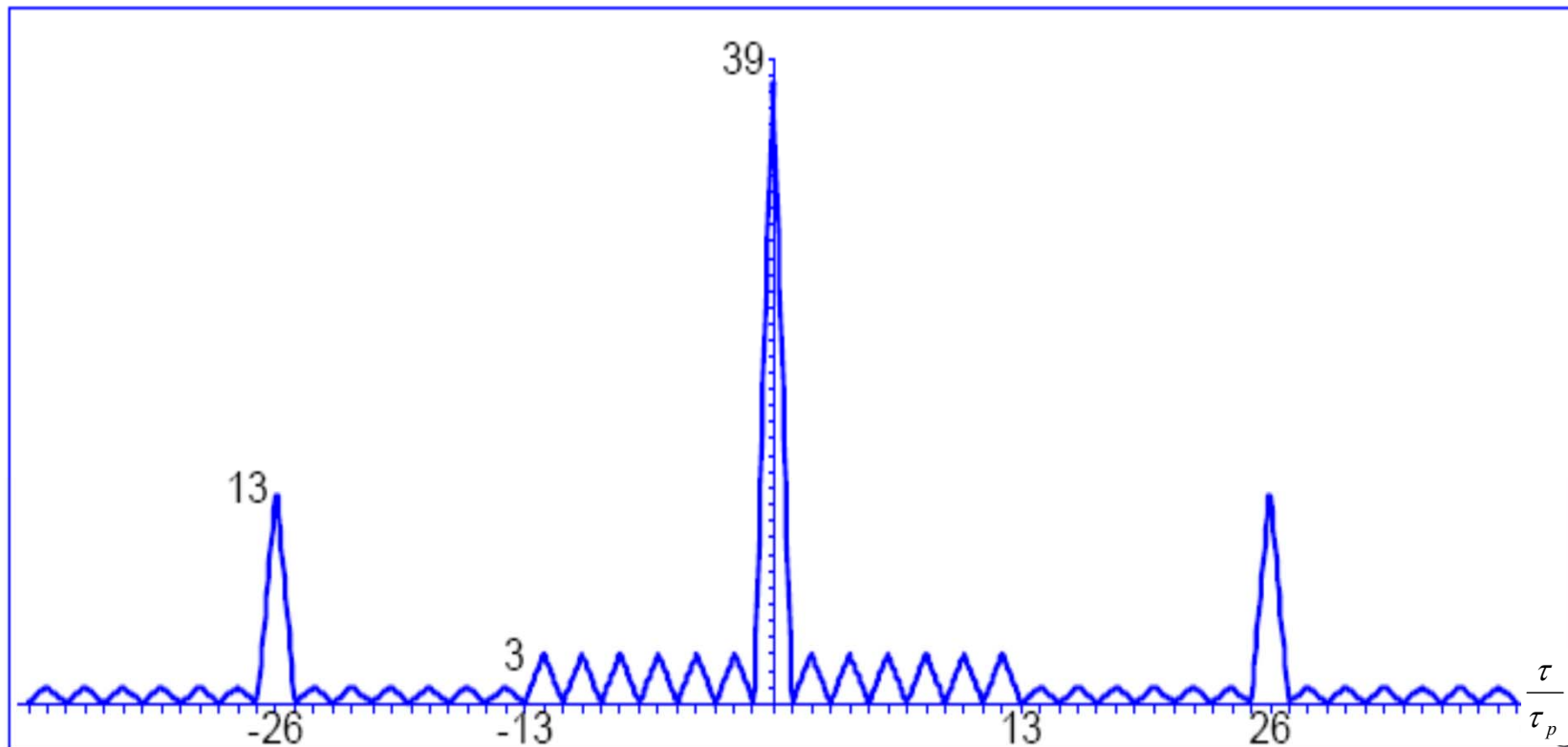

Codici di Barker Polifase

- Usare valori di fase generici (non binari) può portare a lobi più bassi e sequenze lunghe
- Il lobo laterale più lontano dal picco vale sempre 1 (sia per codici binary che polifase)
- Le sequenze polifase con PSLR massimo (escluso il lobo laterale esterno) sono chiamate **sequenze di barker generalizzate** o **sequenze di Barker Polifase**

Codici di Barker Polifase

- **Caso 1:** valori di fase pari alla radice k -esima dell'unità
(es: $k=2$ codici di Barker, $k=6$ sextic Barker codes).
- **Caso 2:** senza restrizione sui valori di fase quantizzati utilizzabili
(sequenze note per valori di $M \leq 36$)

Codici di Barker Polifase (I)

Espressione in forma normalizzata:

i primi due elementi di ogni codice valgono 0 e non sono riportati in tabella.

<i>M</i>	Peak sidelobe	Phase values [°]
4	0.5	104 313
5	0.77	73 225.3 90.6
6	1	58.2 175.9 354.1 234.2
7	0.522	106.4 93 316.7 60.5 270.7
8	0.662	72.1 28.6 294.3 151.7 251.2 63.3
9	0.430	38.7 41.5 270.2 215.1 40.5 160.7 334.3 [el]
10	0.832	60.2 132.1 142.8 18.3 10.7 230.8 22.9 242.9
11	0.892	34.1 259 266.5 327.9 158.4 13.7 22.7 221.5 94.5
12	0.908	104.8 163 170.9 344.3 241 185.5 282.2 147.6 209 78.7
13	0.721	115.8 114.8 248.4 213.4 123.1 154.9 140.2 12.7 149.6 303.5 121.6
14	0.968	66.8 133.5 202.2 100.4 37.5 235.8 167.2 86 168.7 33.5 143.1 13.3
15	0.805	17.8 5.5 5.4 142.4 212 298.1 123.9 91.6 1.3 206 314.2 156.5 23.9
16	0.933	26.5 38.5 97.3 49.4 305.8 286.5 197 65.7 241.3 137.5 319.1 47.9 178.5 303
17	0.733	5.3 18.5 278.4 307.6 67.3 149 207.5 70.6 301.2 282.8 137.3 6.5 120.5 327.9 186
18		(?)
19	0.980	53.3 24.7 90 79.2 232.5 8 331.4 99 240 318.4 159.8 307.8 161.3 137.1 31.8 338.2 217
20	0.979	99.1 125.8 233.1 251.4 133.9 144 354.8 304.5 192.1 302.5 219.5 161.7 283.8 145.4 250.2 106.1 228.4 107

Codici di Barker Polifase (II)

Espressione in forma normalizzata:

i primi due elementi di ogni codice valgono 0 e non sono riportati in tabella.

22	0.995	23.8 53.7 82.1 74.5 349.3 265 314 247.2 147.2 74.6 285.7 160.2 335.4 78.5 317.2 148.4 248.6 344.3 87.8 208.7
23	0.912	7.4 276 286.4 253.9 256.7 351.7 58.4 60.2 226.3 353.1 100.5 168.6 41 208.5 347.8 219.2 125.9 349.7 315.3 182.1 56.3
24	0.997	5 316.4 257.1 216.5 202.4 319 311.1 356.9 296.8 111.2 36.1 280.8 136.9 10.1 115.7 259.2 134.3 268.0 28.0 142.3 208.4 333.8
25	0.936	81.9 65 316.3 273.1 326.3 339.8 62.7 18.8 270.5 198 98.8 126.6 206.5 350.7 105.9 270.8 295.4 162.3 334.2 155.5 339.8 147.7 4.4
26	0.879	51.3 117.1 138.2 265.4 267 175.4 117.8 260.2 200 136.1 154.2 179 75.8 341 187.4 307 194.4 92.5 190.2 17.2 110 250.3 38.7 199.7
27	0.985	10.6 21.9 28.7 324.7 308.4 280.6 118.4 99.2 112.2 284.5 200.6 313.8 116.3 326.7 184.8 53.4 8.8 193.9 97.1 240.9 335.3 103 228.6 332 93
28	0.950	46.9 84.3 166.3 145.7 199.8 105.1 116.6 58.7 109.7 325.9 24.3 189.9 21.4 196.2 58.8 326.5 129.2 259 306.7 123.5 111.2 312.7 298.5 173.8 97.9 327.8
29	0.871	6.9 318.2 239.9 264.7 239.2 160.4 301.5 327.5 18.7 319.7 84.9 108.6 224.1 6.3 31.4 184 167.8 89.9 325.2 227.5 145.4 329.9 91.6 263.7 94 252.9 59.6
30	0.998	33.1 34.6 33.7 11.9 300.1 281.5 26.5 54.2 155.6 211.9 231.6 134.4 76 317.7 275.8 67.6 299 184.6 72.6 153.8 6.6 262.6 94.1 242.8 359.1 149.7 306.4 71.5
31	0.935	28.4 117.7 165.1 236.5 308.7 305 236.5 216.4 327.4 279.5 211.3 247.2 192 95.4 17 273 52.8 331.1 224 303.7 147.2 21.7 245.6 29.3 145.5 297.1 62.4 190.8 7.8
32	0.996	13.5 16.5 90.5 110 95 60.5 333 307 289 281.5 85.5 164 248.5 335 171.5 76 64 221.5 298 110 37 272.5 179.5 19.5 179 288 82.5 292 133 329.5
33	0.990	143 153.5 339 332.5 180.5 133.5 19 108.5 166 216.5 225.5 227.5 318.5 238.5 184.5 226 141.5 113.5 75 36 185.5 327 226.5 108.5 302.5 116.5 273 350 188 356.5 164.5
34	0.997	11 1 307 245 200 184 231 293 300 348 45 227 247 57 335 1 127 249 68 91 315 221 57 116 238 58 287 127 273 127 5 216
35	0.999	93.2 65.4 166.4 132.4 344.1 279.4 337.6 301.3 197.6 56.2 36.8 9.2 325.8 334.3 24.4 157.8 291.1 301.1 148.4 112.9 141.3 296.6 128.7 125.4 341.4 129.9 244.6 73.8 321.5 157.6 300.7 107.5 254.4
36	0.969	82 118 228 228 58 60 154 108 20 234 212 262 236 196 220 116 12 226 178 122 126 76 266 114 256 108 320 100 266 30 124 246 60 186

ACF del codice di Barker Polifase con M=15

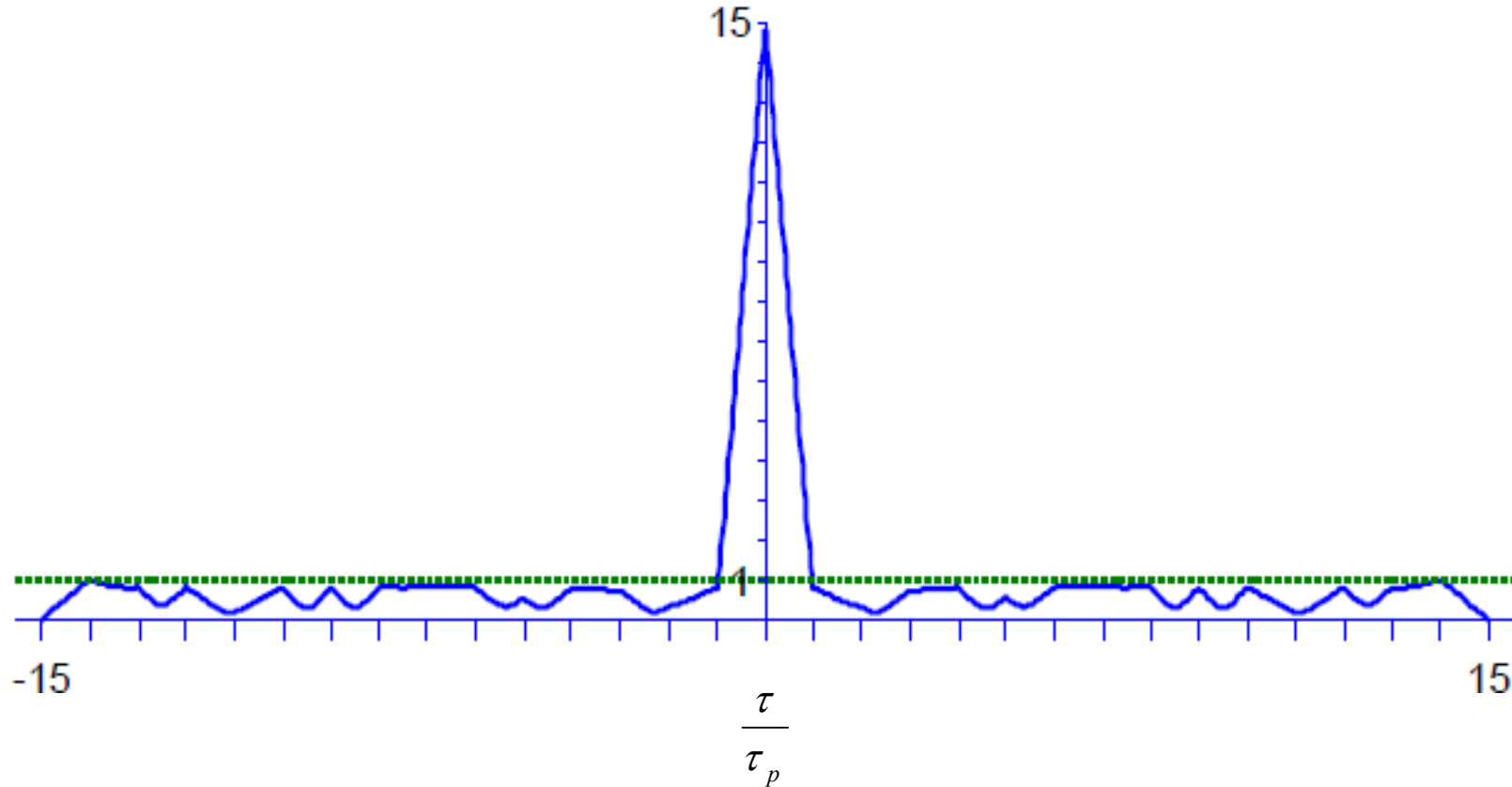

Codici binari con PSL massimo (I)

<i>M</i>	PSL	Sample code
6	2	110100
8	2	10010111
9	2	011010111
10	2	0101100111
12	2	100101110111
14	2	01010010000011
15	2	001100000101011
16	2	0110100001110111
17	2	00111011101001011
18	2	011001000011110101
19	2	1011011101110001111
20	2	01010001100000011011
21	2	101101011101110000011
22	3	0011100110110101011111
23	3	01110001111110101001001
24	3	011001001010111111100011
25	2	1001001010100000011100111
26	3	10001110000000101011011001
27	3	010010110111011101110000111
28	2	1000111100010001000100101101
29	3	10110010010101000000011100111
30	3	100011000101010010010000001111
31	3	0101010010010011000110000001111
32	3	00000001111001011010101011001100
33	3	01100110010101010010110000111111
34	3	1100110011111111100001101001010101
35	3	00000000111100101101010101100110011
36	3	001100110001010010100000100000111110

G. Coxson &
J Russo,
IEEE Trans
on AES
Jan 2005

Radiotecnica e Ra

Codici binari con PSL massimo (II)

37	3	0010101110100001001110110111110011110
38	3	00000000111100001101001010101001100110
39	3	001001100110101000010111110111100111100
40	3	0010001000100011110111000011101001011010
41	3	000111000111010100101001000000001101100100
42	3	000100010001000111101110000111010010110100
43	3	0000000010110110010101011001100111000011100
44	3	00001111111011001110110010110010101011010111
45	3	00010101011110000110011000110110110111110110
46	3	0000111100000011001111011110110110010101010110
47	3	00001101001101001111110100001010001100110001000
48	3	00010101011010110110000111100110010011111110011
49	4	0000100101010101111101100011110011110010001101111
50	4	00001001011000011000111010101111000010011001101111
51	3	00011100011111110001000110010001001010100100101011
52	4	0000100101000101101011100000111100110010010001101111
53	4	00001001100101010101001111111100011010010110001101111
54	4	000010011001101010001010000001010010110011110001101111
55	4	0000100110000100110101010100001111000110010010001101111
56	4	00001001100110111010101011001011010001111011110001101111
57	4	000010010011010001010100011101101011000100011110001101111
58	4	0000100011110011100101010001011100100111101101011001101111
59	4	00001001001110100111000000100101000101000011101110001101111
60	4	000010101011100011011111000011001001011100110010010100101111
61	4	00000010110110100010011000100110001111001111101010001101010000
62	4	00000000101101011001100110001101001100101100000111010001010000
63	4	000010011001111010110100010010001110001011001010111110001101111
64	4	010000001001000010100010111010011110011000110010001101111000010
65	4	000000010110111100000010110000110110011011110011100101010001010000
66	4	0000000110100110110100001010100011100111001111100010010101101000010
67	4	0100000010100000110110010011010101100011110100100001001110011000010
68	4	00000000100111100100100111100011011001100010101010001110101001010000
69	4	000100110111111011011000010011010100000111010000100011000111000010101
70	4	0110100001001100111011010011100011000010010011111011011101010101111110

Lobi laterali

Quanto è importante ridurre i lobi laterali?

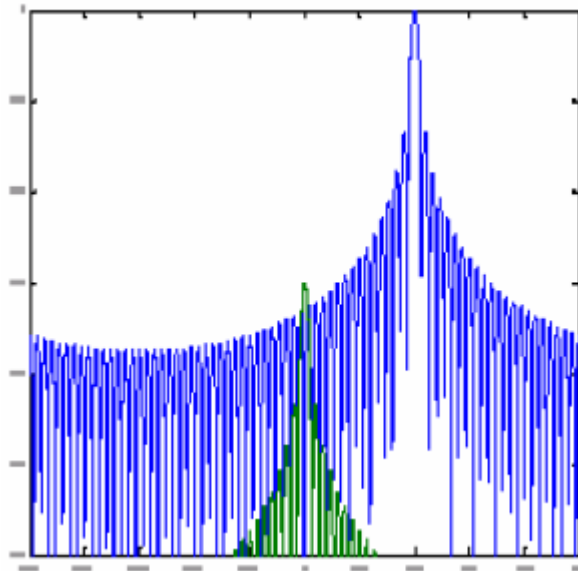

Senza pesatura

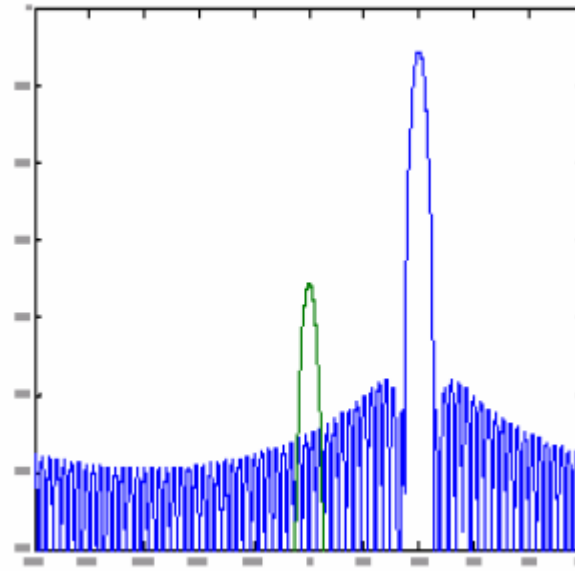

con pesatura di Hamming

Codici con ACF ideale

- **E' possibile trovare una sequenza di impulsi con ACF ideale (lobi laterali a zero) ?**

NO

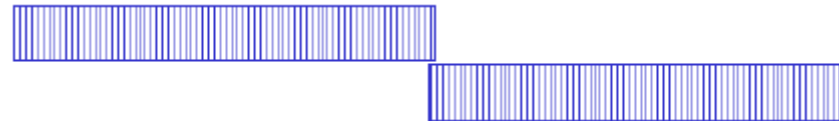

- Ci si può avvicinare di più a tale ACF usando i codici di Huffman, che richiedono modulazione di ampiezza e fase

Codice Polifase di Frank (I)

- Usando M valori di fase
- Numero di elementi $N=M^2$
- Costruito dalle righe della matrice quadrata:

$$\phi_{pq} = \frac{2\pi}{M}(p-1)(q-1) \quad p, q = 1, \dots, M$$

- Per $N=16$

$$\phi_{pq} \begin{bmatrix} 0 & 0 & 0 & 0 \\ 0 & \pi/2 & \pi & 3\pi/2 \\ 0 & \pi & 2\pi & 3\pi \\ 0 & 3\pi/2 & 3\pi & 9\pi/2 \end{bmatrix}$$

$$S_{0pq} = e^{j\phi_{pq}} \begin{bmatrix} 1 & 1 & 1 & 1 \\ 1 & j & -1 & -j \\ 1 & -1 & 1 & -1 \\ 1 & -j & -1 & j \end{bmatrix}$$

Codice Polifase di Frank (II)

$$\phi_m = \frac{2\pi}{M}(m-1)\left(\left\lfloor \frac{m}{M} \right\rfloor - 1\right) \quad m = 1, \dots, M^2$$

Forma di quantizzazione di un segnale chirp

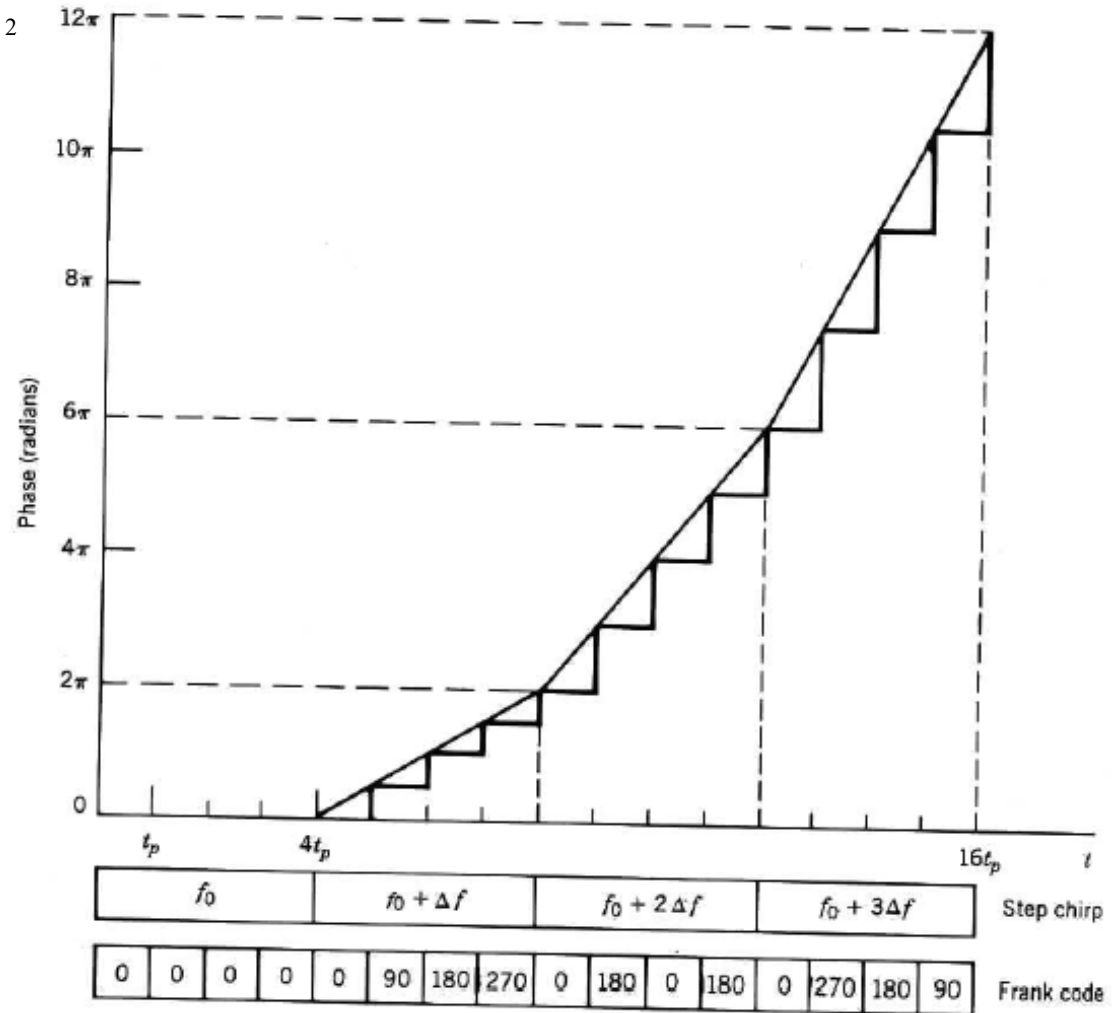

Codice Polifase di Frank (III)

Table 8.5 The Autocorrelation Sequence of a 16-Bit Frank Code

$\{u_n\}$	1	1	1	1	1	j	$-j$	1	-1	1	-1	1	$-j$	-1	j																
$\{u_{n+1}^*\}$																															
$-j$	$-j$	$-j$	$-j$	$-j$	$-j$	1	j	-1	$-j$	j	$-j$	j	-1	j	1																
-1		-1	-1	-1	-1	-1	$-j$	1	j	-1	1	-1	1	-1	j	$-j$															
j			j	j	j	j	-1	$-j$	1	$-j$	j	-1	j	1	$-j$	-1															
1				1	1	1	1	1	1	1	1	1	1	1	1	1															
-1					-1	-1	-1	-1	-1	-1	-1	-1	-1	-1	-1	-1															
1						1	1	1	1	1	1	1	1	1	1	1															
-1							1	1	1	1	1	1	1	1	1	1															
1								1	1	1	1	1	1	1	1	1															
-1									1	1	1	1	1	1	1	1															
j										j	$-j$	j	$-j$	j	$-j$	j															
-1											-1	-1	-1	-1	-1	-1															
$-j$												$-j$	$-j$	$-j$	$-j$	$-j$															
1													1	1	1	1															
1														1	1	1															
1															1	1															
1																1															
1																	1														
Output seq.	$-j$	-1	-1	0	-1	1	j	0	j	-1	1	0	1	1	$-j$	16	j	1	1	0	1	-1	$-j$	0	$-j$	1	-1	0	-1	-1	j

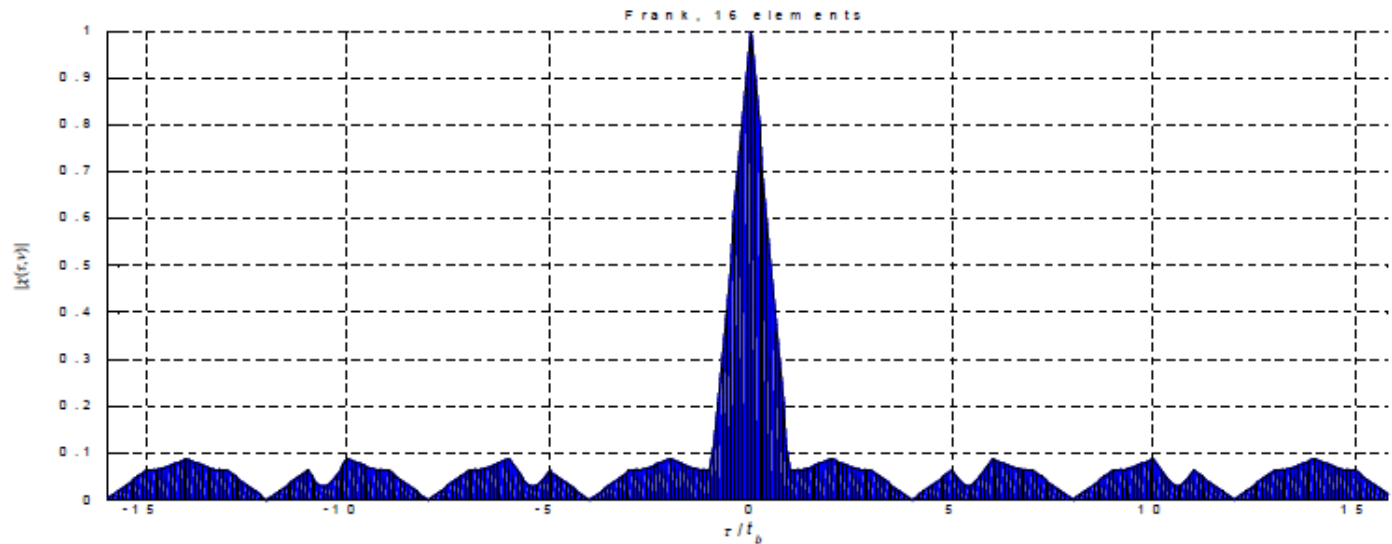

Codice Polifase di Frank (IV)

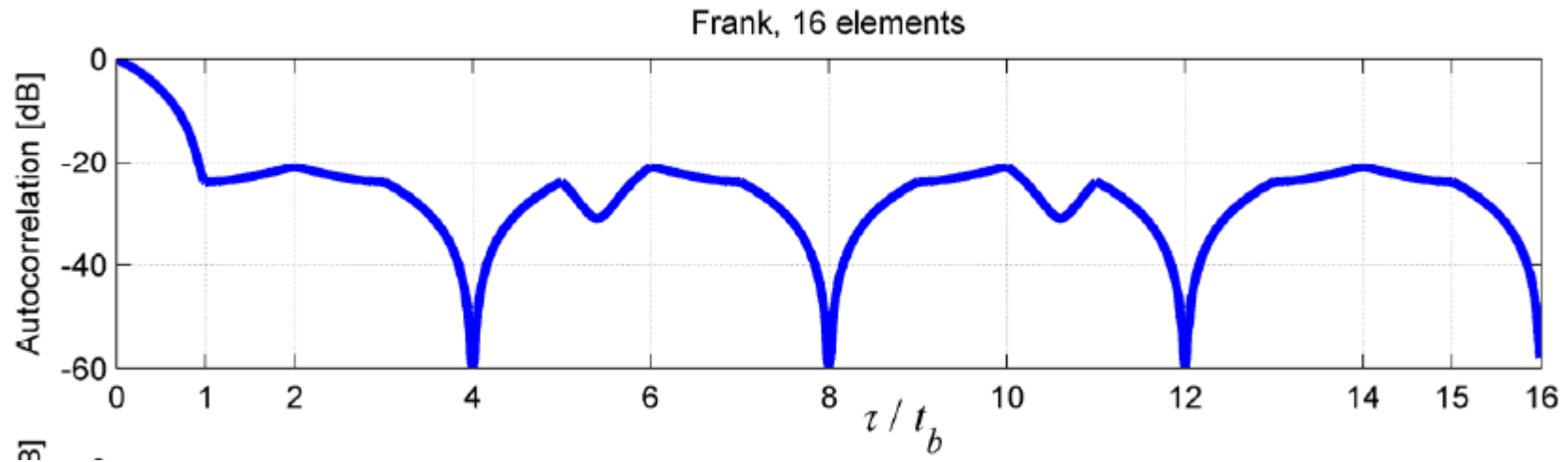

Per $N=16$ $PSR = \frac{16}{\sqrt{2}} = 8\sqrt{2} = 11,3$ (21dB) *(peggiore di Barker)*

Per N grande $PSR = \pi \sqrt{N} = \pi M \Rightarrow 9.94 + 10 * \log_{10}(N)$

($N=100 \sim 30$ dB)

Codici Polifase P3 e P4 (I)

Codice P3

per M pari $\phi_m = \frac{\pi}{M}(m-1)^2 \quad m = 1, \dots, M$

per M dispari $\phi_m = \frac{\pi}{M}(m-1)m \quad m = 1, \dots, M$

Codice P4

$$\phi_m = \frac{\pi}{M}(m-1)^2 - \pi(m-1) \quad m = 1, \dots, M$$

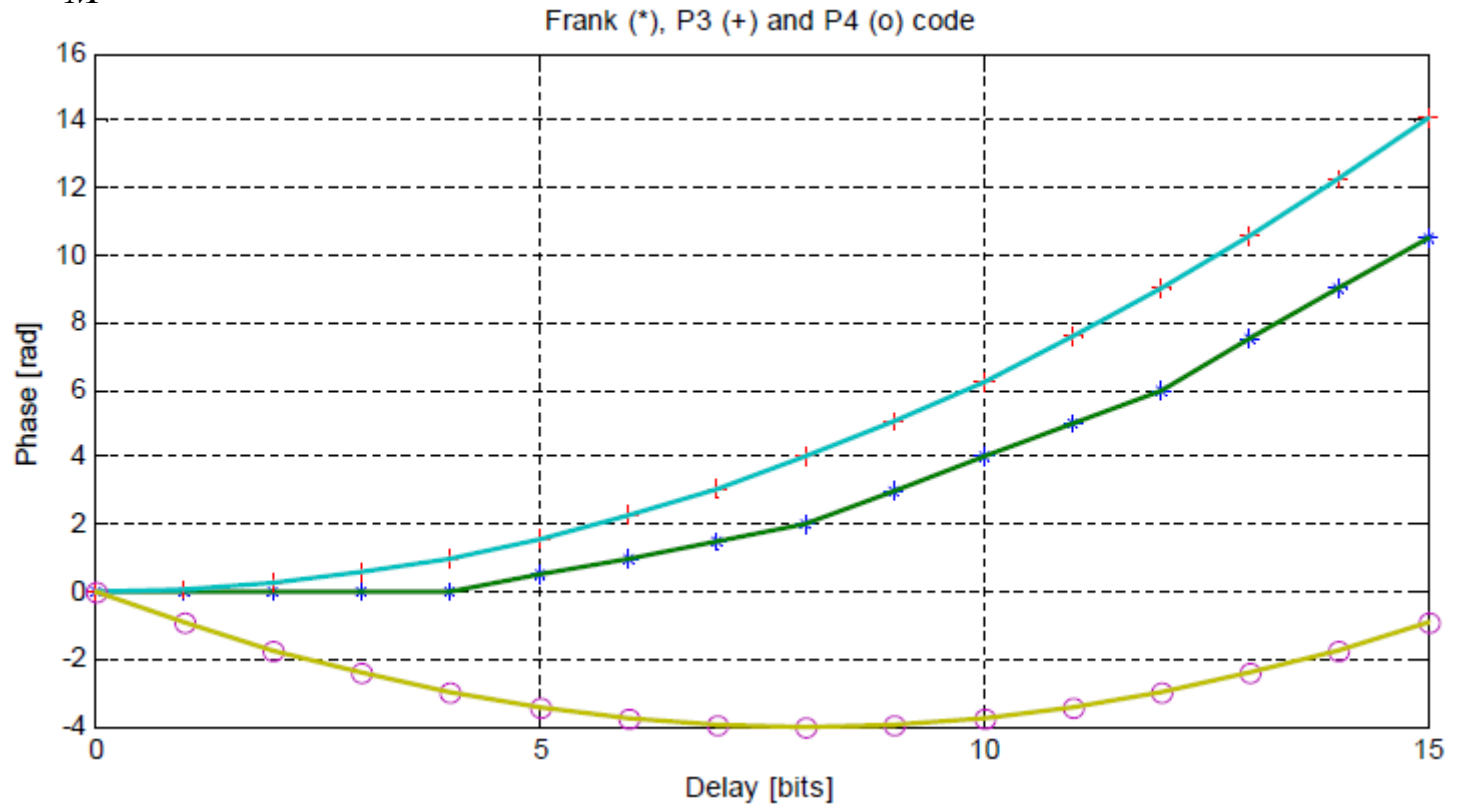

Codici Polifase P3 e P4 (III)

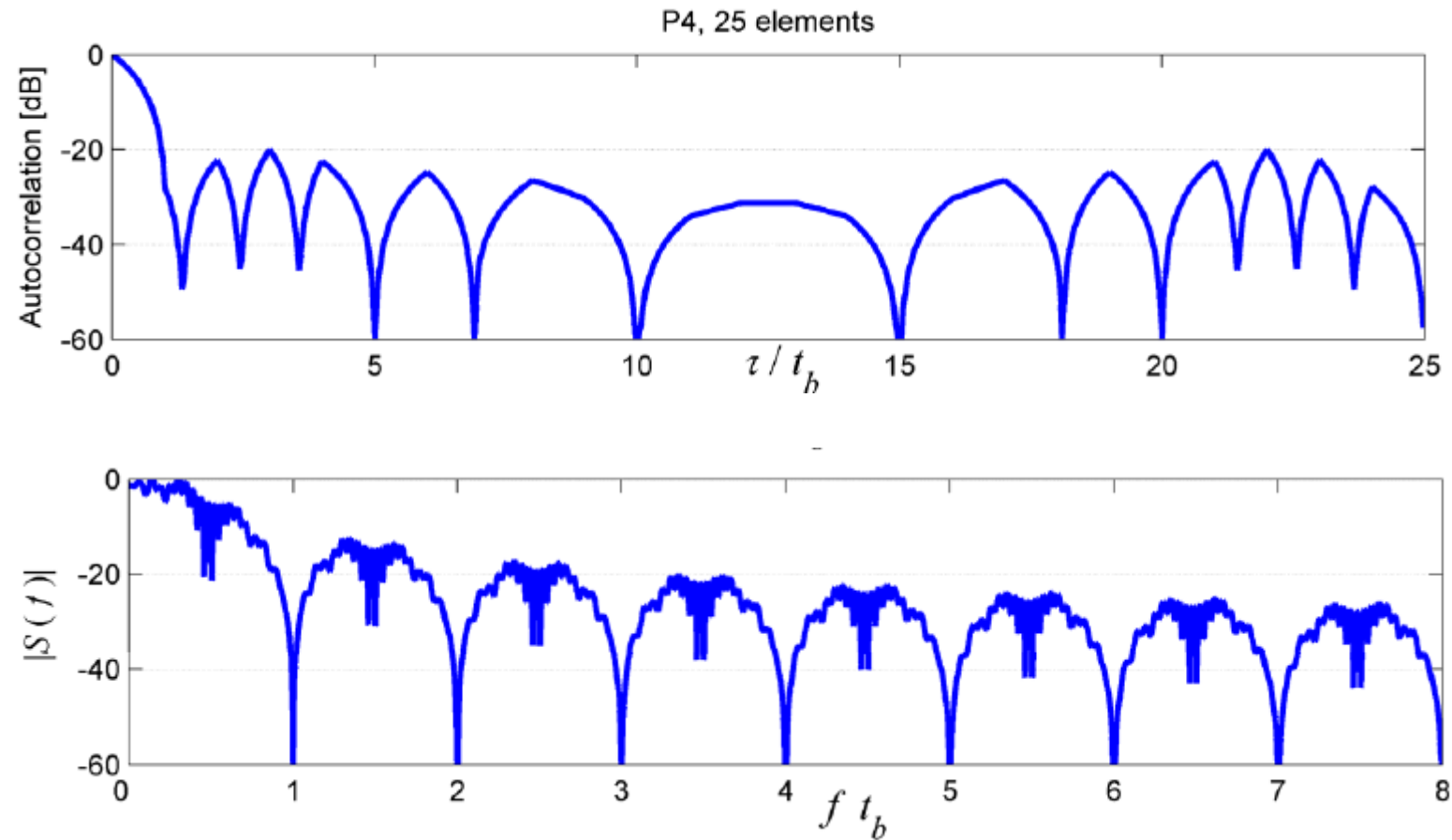

Filtro adattato al singolo impulso

- Per $\tau_p < T/2$:

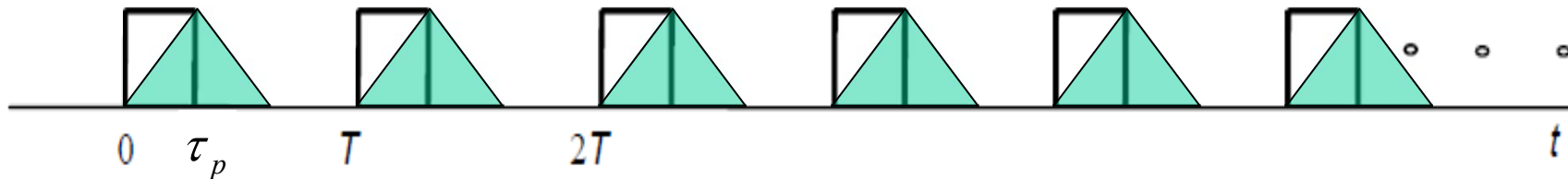

- Per $\tau_p = T$:

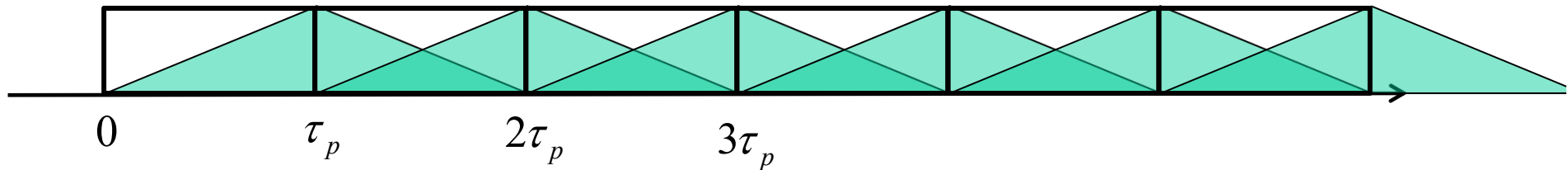

- **Periodic Ambiguity Function**

$$|\chi_P(\tau, \nu)| = \left| \int_0^T s_0(t) s_{0P}^*(t + \tau) e^{j2\pi\nu t} dt \right|$$

$$|\chi_P(\tau, \nu)| = \left| \int_0^T s_0(t) \sum_{n=-\infty}^{\infty} s_0^*(t - n \cdot T + \tau) e^{j2\pi\nu t} dt \right|$$

PAF del Barker 4

1	1	-1	1	1	1	-1	1	1	1	-1	1	1	1	-1	1	1	1	-1	1
1	1	-1	1																
	1	1	-1	1															
		1	1	-1	1														
			1	1	-1	1													
				1	1	-1	1												
					1	1	-1	1											
						1	1	-1	1										
							1	1	-1	1									

4 0 0 0 4 0 0

**Autocorrelazione
periodica perfetta!**

PAF dei codici di Frank

Frank 16

Autocorrelazione periodica perfetta!

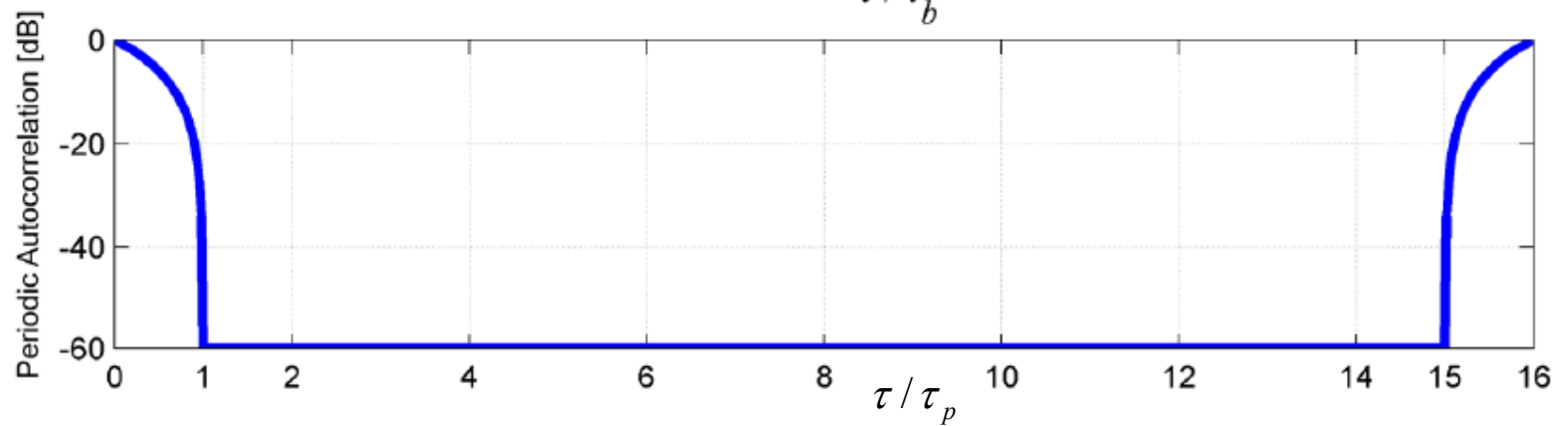
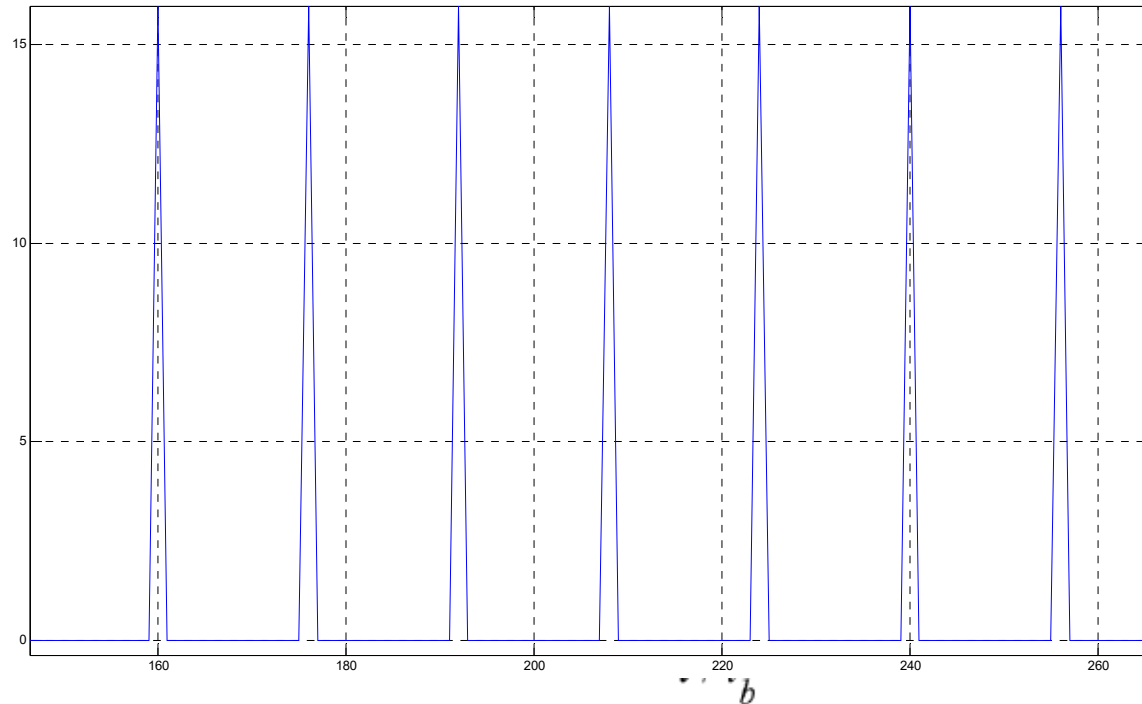

PAF dei codici P4

P4 da 25 elementi

**Autocorrelazione
periodica perfetta!**

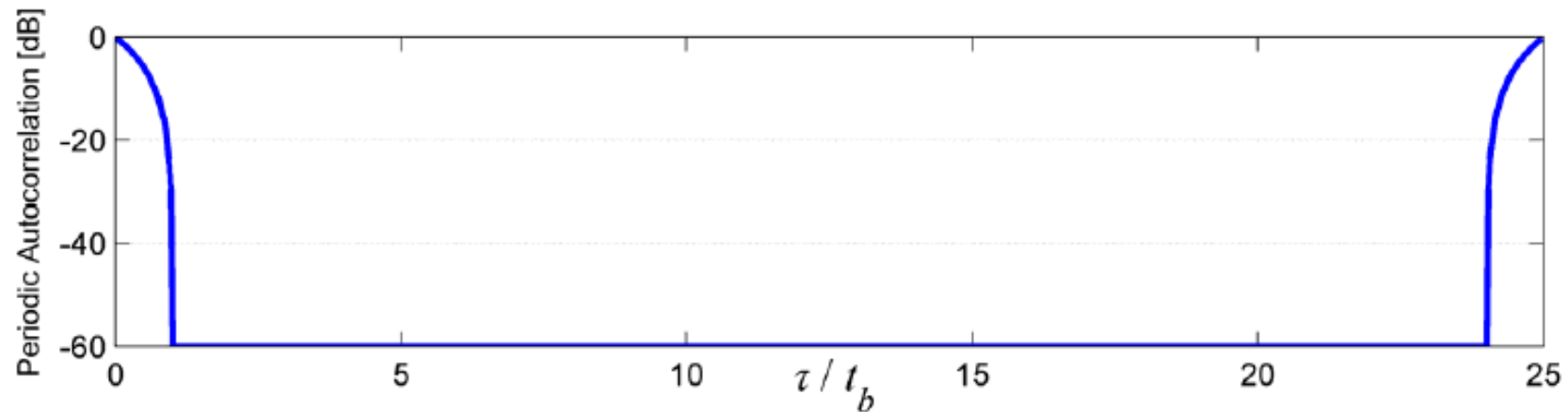

CHIRP: linear frequency modulated signal

MAXIMUM RADAR RANGE

$$R_{\max} = 4 \sqrt{\frac{E_T G^2 \lambda^2 \sigma}{(4\pi)^3 K T_0 F S_a}} \quad \text{Con } E_T = P_p T$$

RANGE RESOLUTION

$$R_d = \frac{cT}{2}$$

CHIRP: LINEAR FREQUENCY MODULATION

$$s(t) = e^{j2\pi(f_p t + \frac{B}{T} \cdot \frac{t^2}{2})} \text{rect}_T(t)$$

B chirp bandwidth
T transmitted pulse length
 f_p (residual) carrier frequency

- CHIRP (long pulse with phase coding): has the power properties of the long pulse and the resolution properties of the short pulse.
- Phase coding → waveform compression by means of matched filtering

CHIRP: Time domain waveform (I)

$$s(t) = e^{j2\pi(f_p t + \frac{B}{T} \cdot \frac{t^2}{2})} \text{rect}_T(t)$$

- CHIRP MODULUS DEL $|s(t)|$:

$$|s(t)| = \begin{cases} 1 & \text{Per } |t| \leq T/2 \\ 0 & \text{Per } |t| \geq T/2 \end{cases}$$

- CHIRP PHASE $\Phi(t)$

$$\Phi(t) = 2\pi(f_p t + \frac{B}{T} \cdot \frac{t^2}{2})$$

- INSTANTANEOUS FREQUENCY $f(t)$

$$f(t) = \frac{1}{2\pi} \cdot \frac{d\Phi(t)}{dt} = f_p + \frac{B}{T} t$$

$$f(-T/2) = f_p - B/2$$

$$f(T/2) = f_p + B/2$$

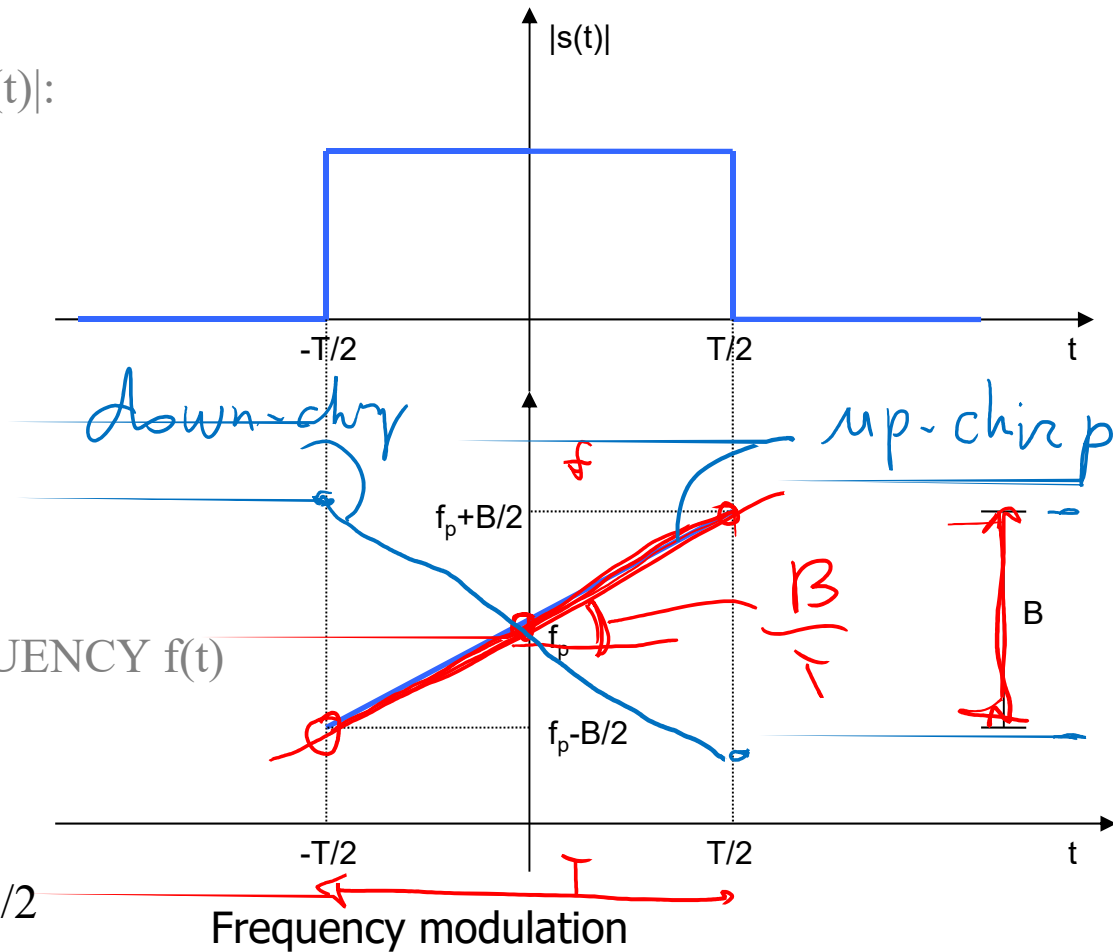

CHIRP: Time domain waveform (II)

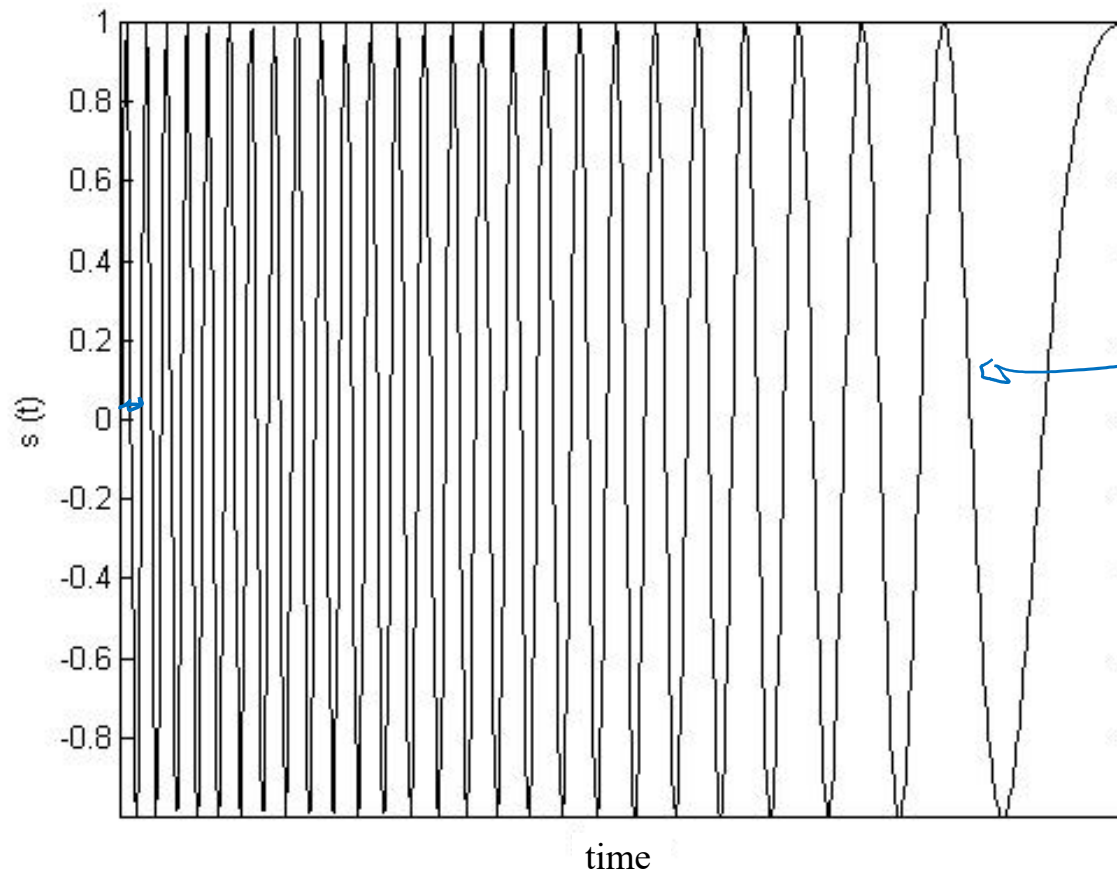

CHIRP: Time domain waveform (III)

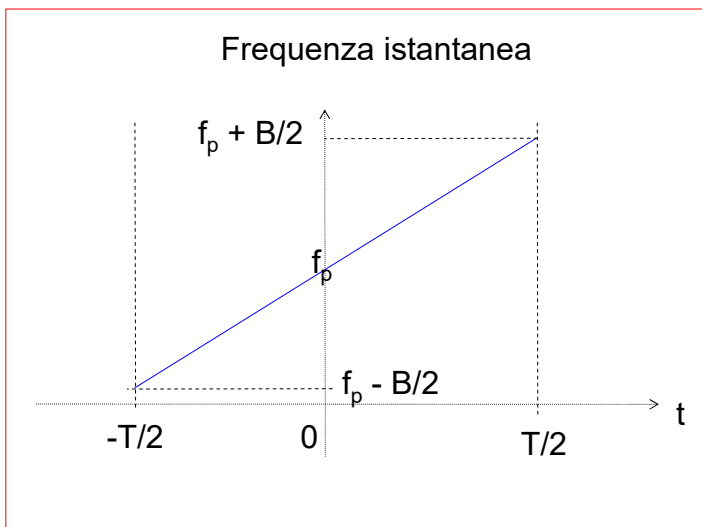
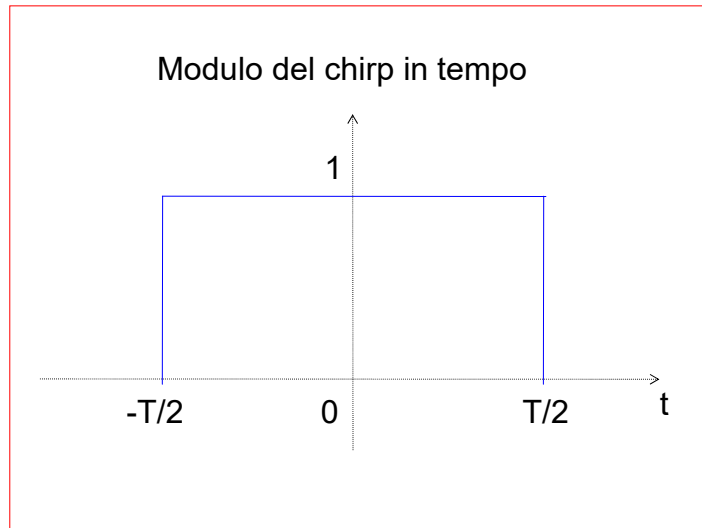

CHIRP: Frequency domain waveform (I)

AMPLITUDE SPECTRUM

PHASE SPECTRUM

For high BT values ($BT > 100$)

$$|S(f)| \cong \frac{1}{\sqrt{2\mu}} \sqrt{2} = \frac{1}{\sqrt{\mu}} = \sqrt{\frac{T}{B}} \quad |f| \leq B/2$$

For high BT values ($BT > 100$)

$$\Phi(f) \cong -\frac{\pi}{\mu} f^2 + \frac{\pi}{4} \quad |f| \leq B/2$$

$$S(f) = \sqrt{\frac{T}{B}} e^{-j\left[\pi \frac{T}{B} f^2 - \frac{\pi}{4}\right]} \text{rect}_B(f)$$

$$\mu = \frac{B}{T}$$



$$t \rightarrow \frac{B}{T} \quad f \rightarrow \frac{1}{B}$$

CHIRP: Frequency domain waveform (II)

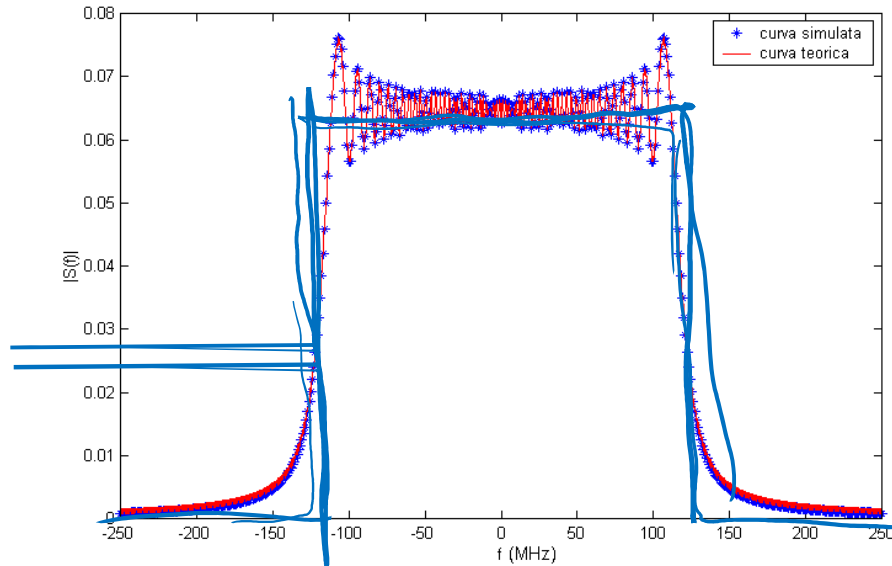

Chirp amplitude spectrum for $B=240\text{MHz}$, $T=1\mu\text{s}$

$T = 100\mu\text{s}$

Alta risoluzione $r_{15} = \frac{c}{2B}$
 ↓
 piccolo
 Banda larga $B = \frac{c}{2r_{15}} = \frac{3 \cdot 10^8}{2 \cdot 0,5}$

Chirp phase spectrum for $B=240\text{MHz}$, $T=1\mu\text{s}$

300 MHz

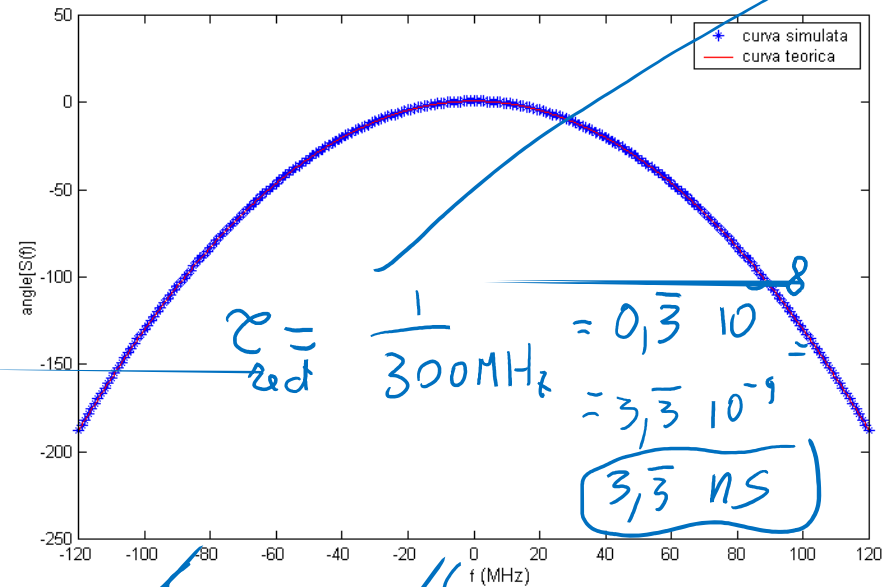

$\tau = \frac{1}{2 \cdot \Delta f} = \frac{1}{2 \cdot 300\text{MHz}} = 0,3 \cdot 10^{-9} = 3,3 \cdot 10^{-10} = 3,3 \text{ ns}$

$300 \cdot 10^6 \cdot 100 \cdot 10^{-6} = 30.000$

45 dB

CHIRP: Frequency domain waveform (III)

Unmodulated RF pulse.
 $t_p \cdot \beta_3 = 1.$

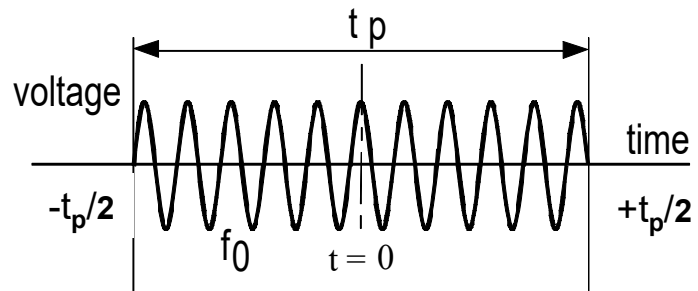

3dB bandwidth $\beta_3 = 1/t_p$

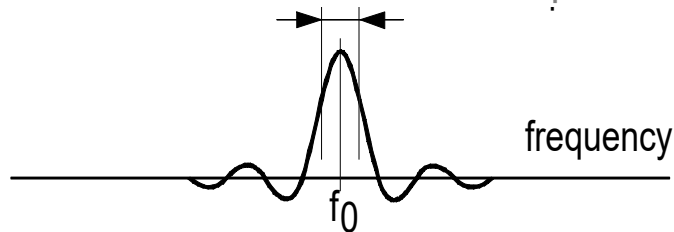

UP-sweep linear
FM chirp pulse.

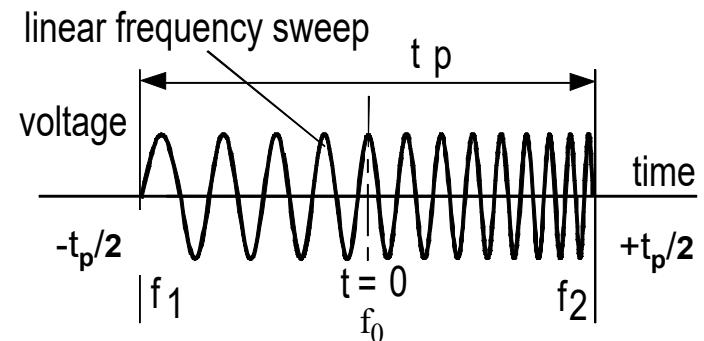

Sweep bandwidth $\beta_s = (f_2 - f_1)$

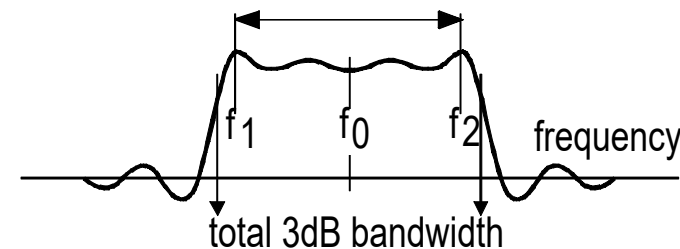

Chirp approximation and sidelobes (I)

- Chirp autocorrelation (matched filter output)

$$g(t) = \sqrt{\frac{B}{T}} \frac{\sin \left[\pi \frac{B}{T} (T - |t|) t \right]}{\pi \frac{B}{T} t}$$

$t \approx 0$

- approximated with

$$g(t) \cong \sqrt{\frac{B}{T}} \frac{\sin[\pi B t]}{\pi \frac{B}{T} t} = \sqrt{BT} \sin c[\pi B t]$$

which is the Inverse Fourier Transform of a rectangle in the frequency domain

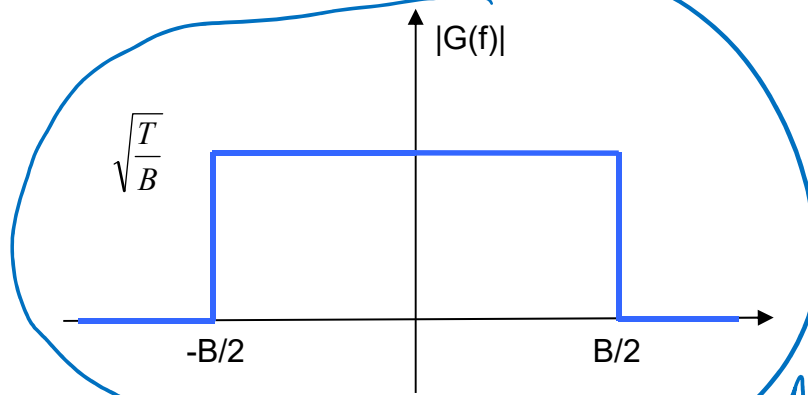

$$|G(f)|^2 = \frac{T}{B} \text{rect}_B(f)$$

$$|G(f)| = \sqrt{\frac{T}{B}} \text{rect}_B(f)$$

$$A(f) = T \text{sinc}(\pi B t)$$

Pulse compression technique (I)

- Matched Filter

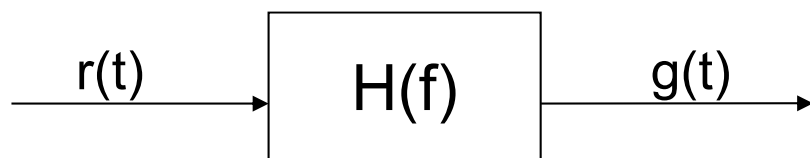

$$r(t) = e^{j2\pi\left(f_p t + \frac{B}{T} \frac{t^2}{2}\right)} \text{rect}_T(t)$$

Received signal

$$h(t) = \sqrt{\frac{B}{T}} e^{-j2\pi\left(-f_p t + \frac{B}{T} \frac{t^2}{2}\right)} \text{rect}_T(t)$$

matched filter
impulse response

$$g(t) = r(t) * h(t) = \int_{-\infty}^{\infty} r(\tau) h(t - \tau) d\tau$$

matched filter
output

$$g(t) = \sqrt{\frac{B}{T}} \frac{\text{sen}\left[\pi \frac{B}{T} (\tau - |t|) t\right]}{\pi \frac{B}{T} t} e^{j2\pi f_p t}$$

sin x/x signal envelope:
with -4dB aperture = 1/B.

- ✓ $g(t)$ autocorrelation of the input signal ($f_d=0$).
- ✓ for $f_d \neq 0$ mismatched filter

The pulse has been
compressed to:
 $\tau_c = 1/B < T$

Pulse compression technique (II)

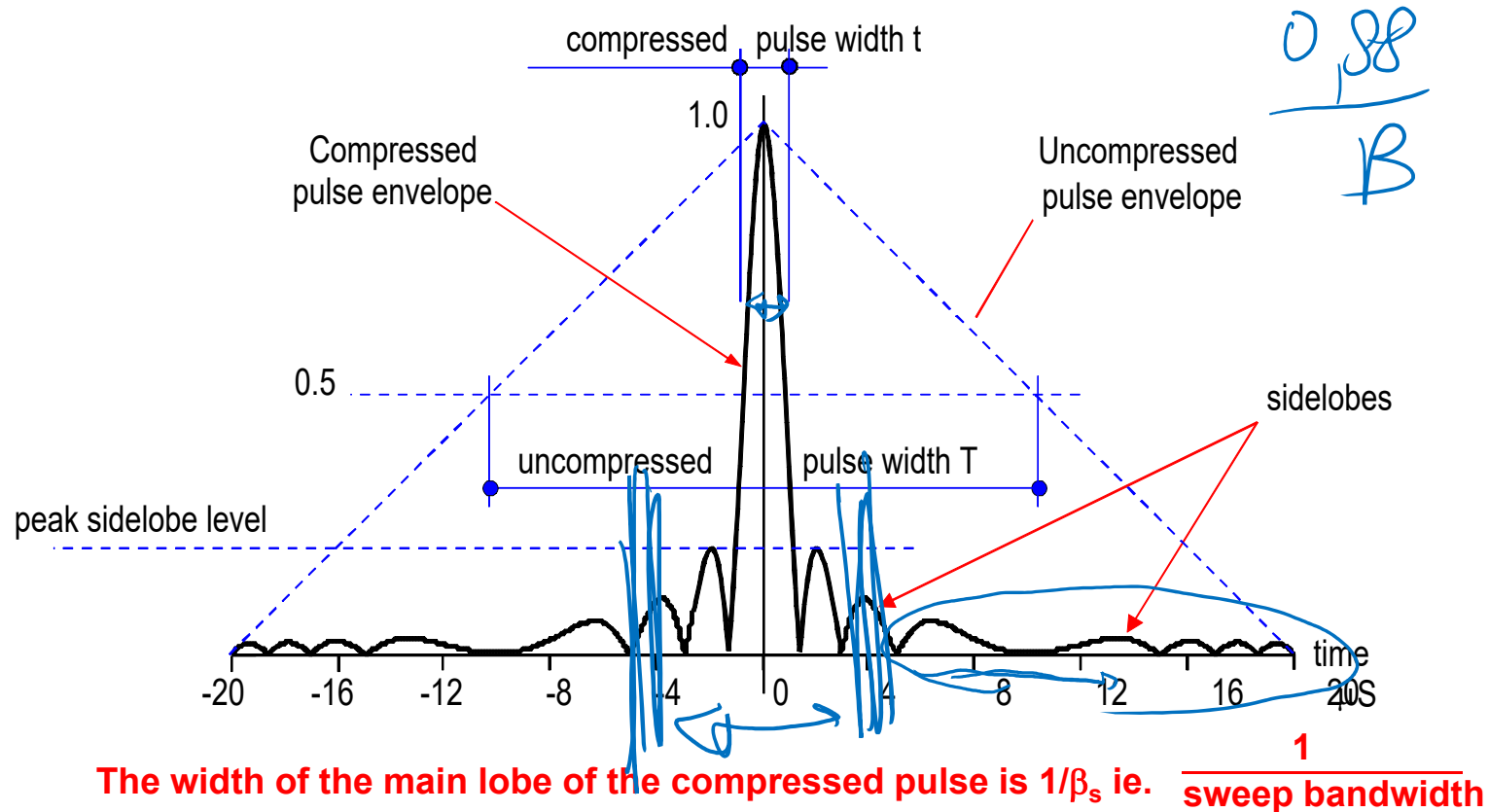

Pulse compression technique (III)

$$f_s = B \quad (2B)$$

~~$$f_s = \frac{1}{B} \quad \left(\frac{1}{2B}\right)$$~~

Matched filter output

$$N_c \approx \frac{T}{t_s} \approx \frac{T}{1/B} = BT$$

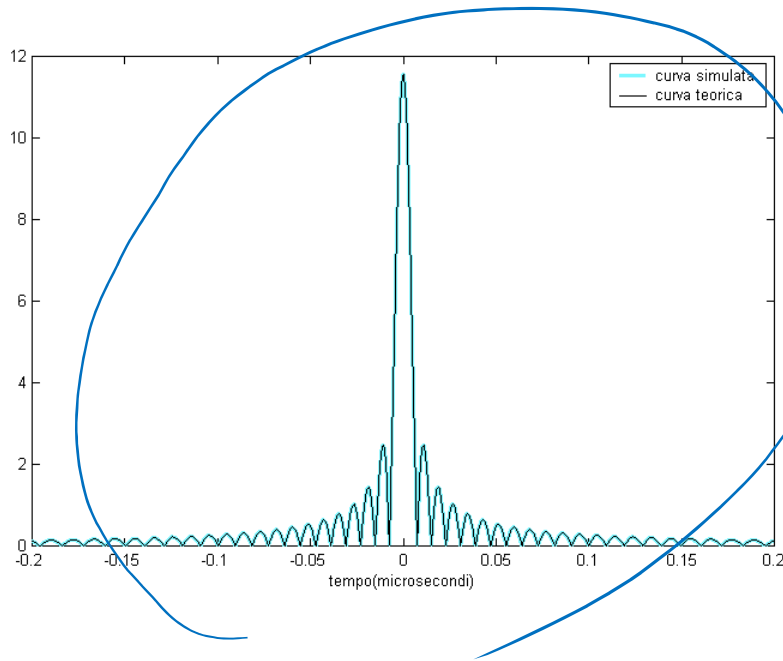

Matched filter output
for: $B=133.5$ MHz
and $T=1$ μ s

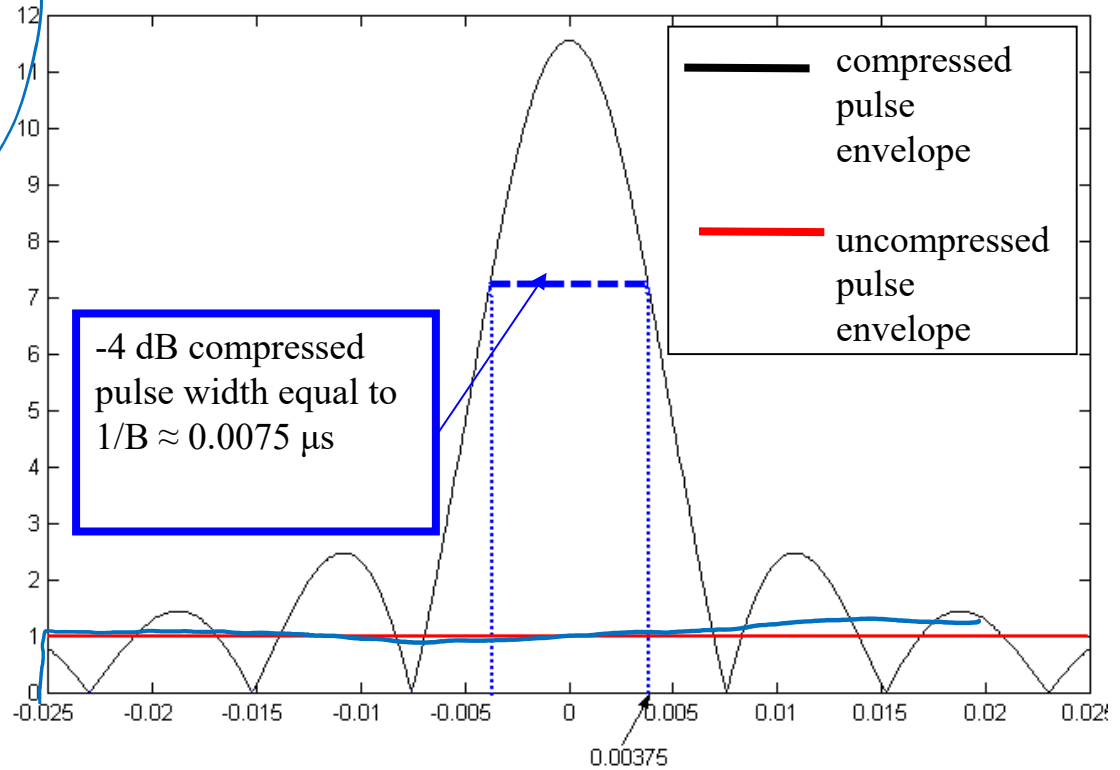

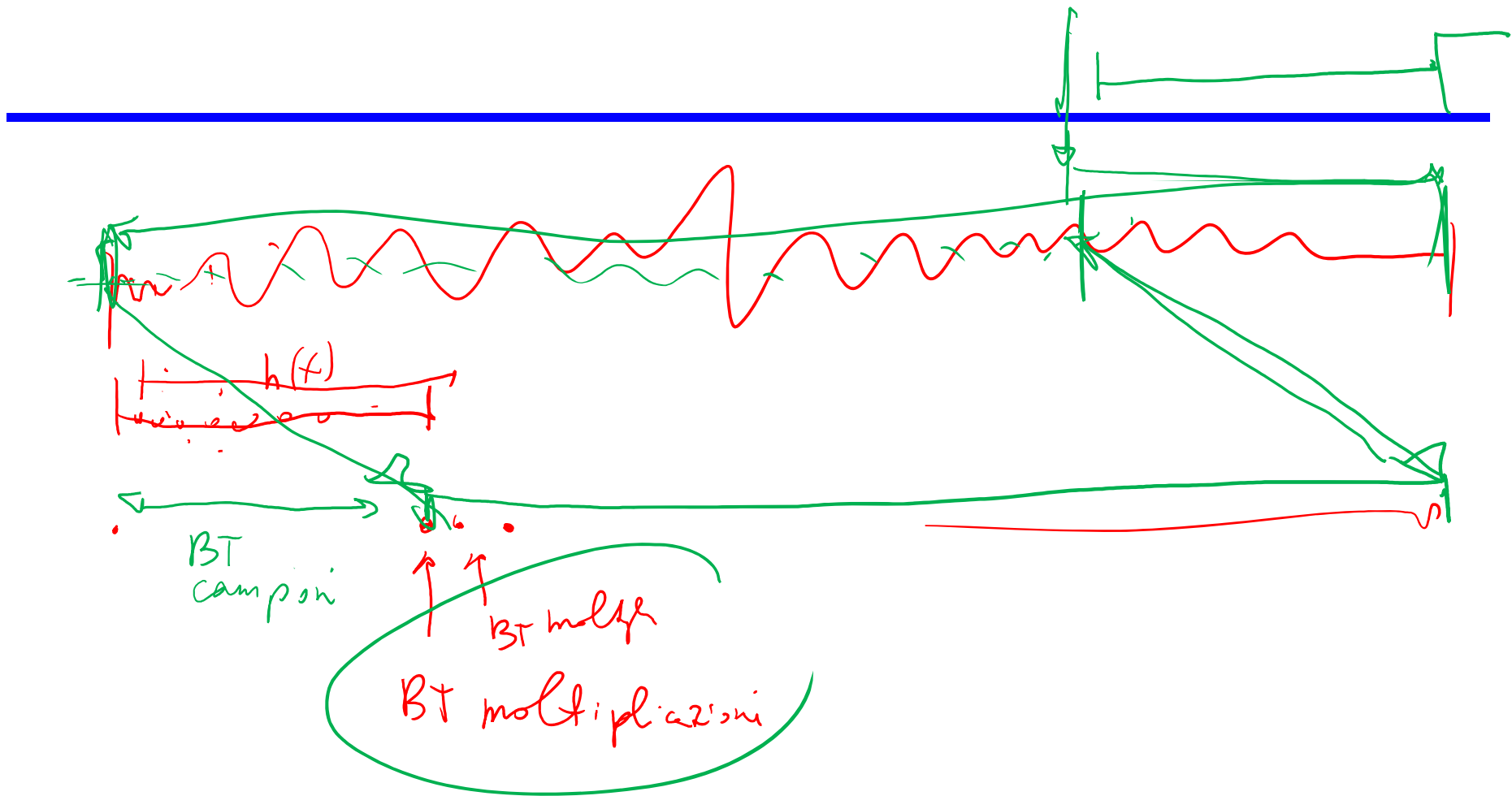

Pulse compression technique (IV)

Matched filter output : sidelobes

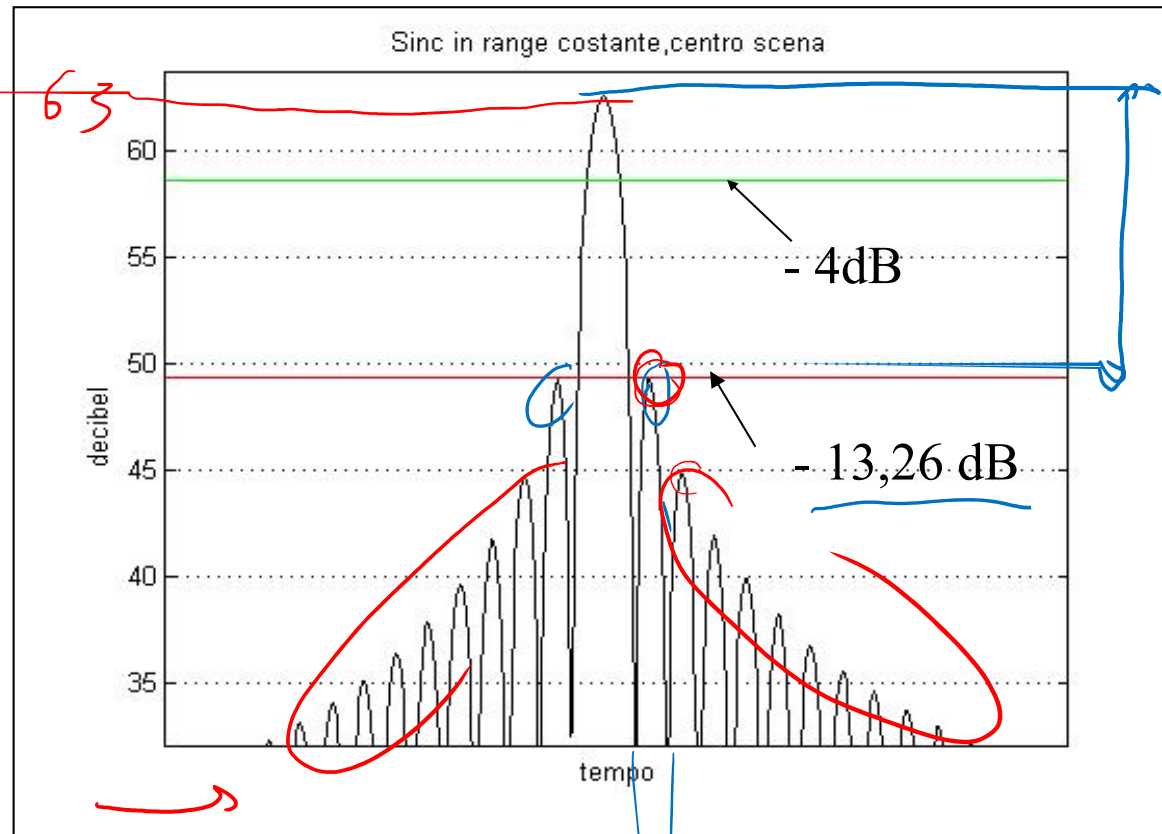

SAW pulse compression (I)

Surface Acoustic Waves

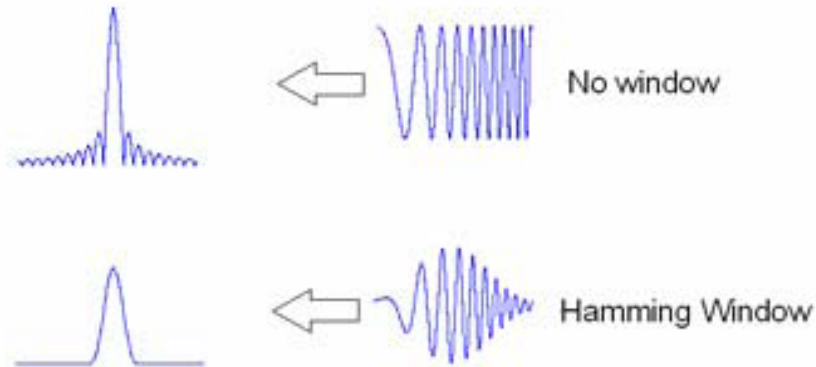
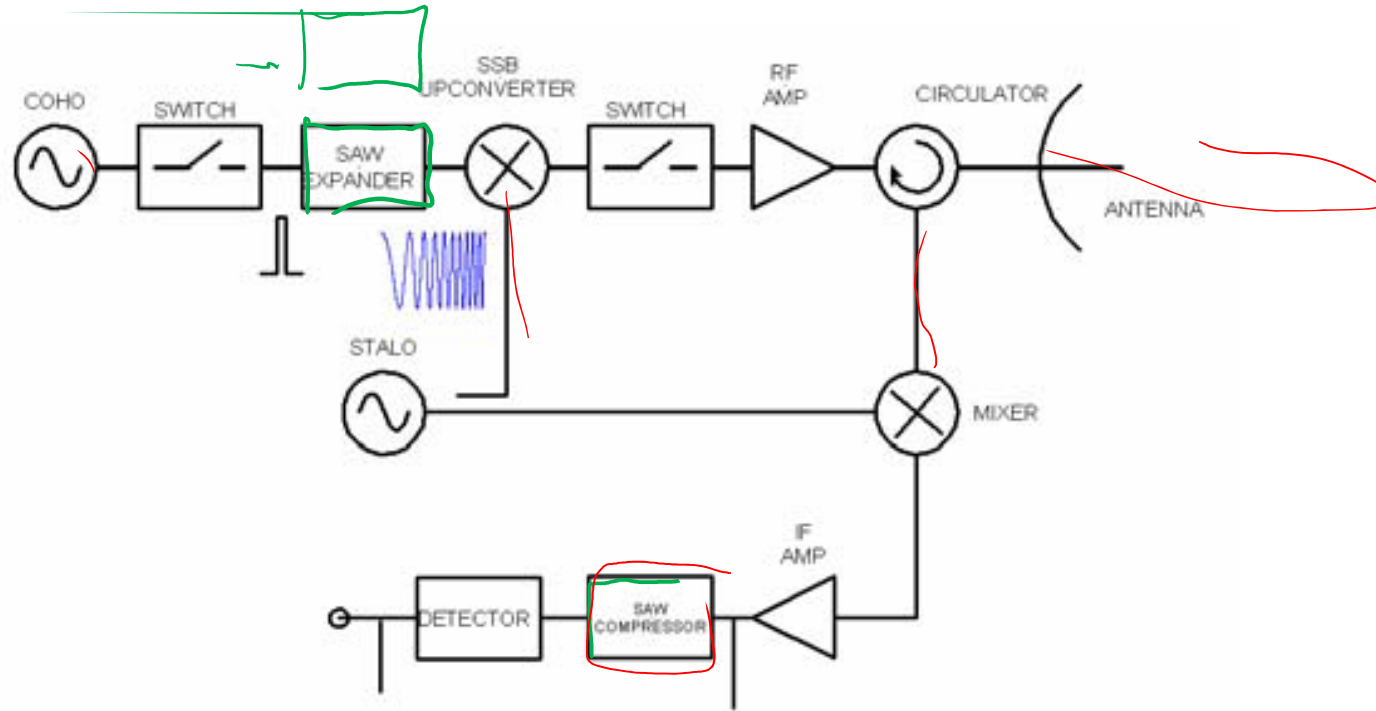

SAW pulse compression (II)

- In a pulse compression system, a very brief pulse consisting of a range of frequencies passes through a dispersive delay line (SAW expander) in which its components are delayed in proportion to their frequency.
- In the process the pulse is stretched; for example a 1ns pulse may be lengthened by a factor of 1000 to a duration of 1 μ s before it is up-converted amplified and transmitted.
- A constant amplitude waveform is produced in which the frequency increases or decreases linearly by Δf over the duration of the pulse

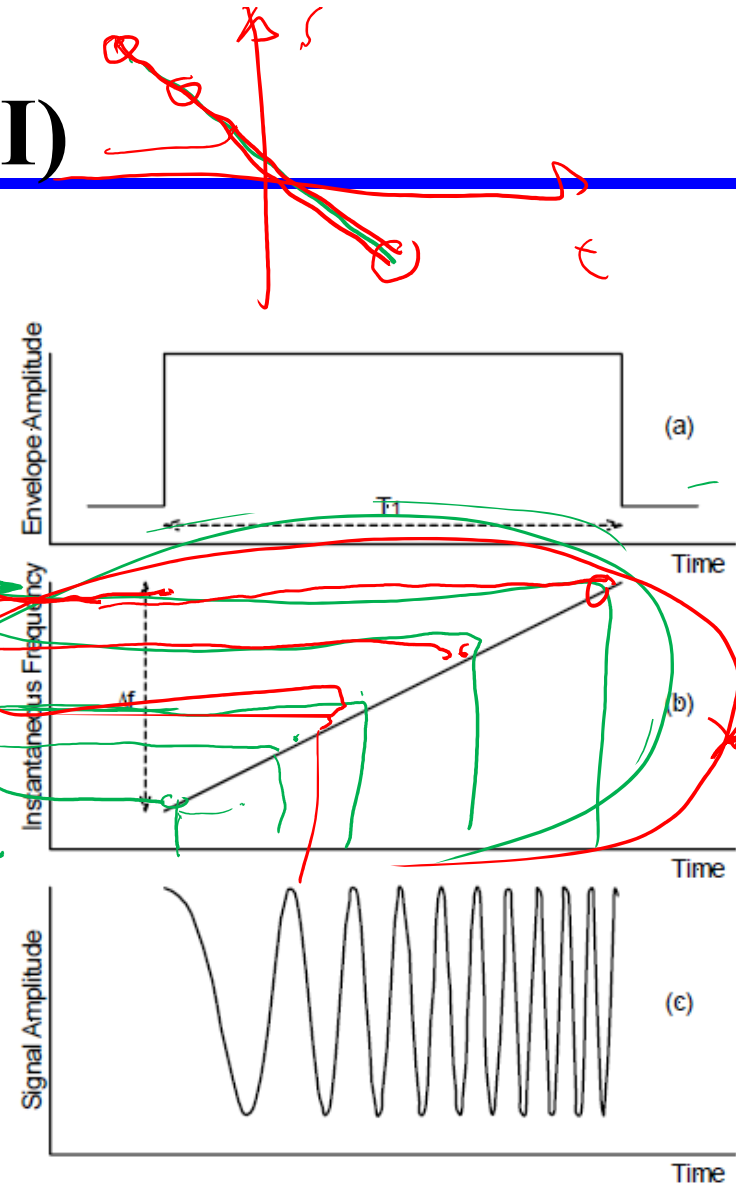

SAW pulse compression (III)

- The echo returns from the target are down converted and amplified
- It is then passed through a pulse compression filter which is designed so that the velocity of propagation is proportional to frequency
- The pulse is compressed to a width $1/\Delta f$
- The compressed echo yields nearly all of the information that would have been available had the unaltered 1ns pulse been transmitted.
- The amount of signal-to-noise ratio (SNR) gain achieved is approximately equivalent to the pulse time-bandwidth product $\beta \cdot \tau$.
- Most pulse compression systems use surface acoustic wave (SAW) technology to implement the pulse expansion and compression functions
- The maximum $\beta \cdot \tau$ product that is readily available is about 1000.

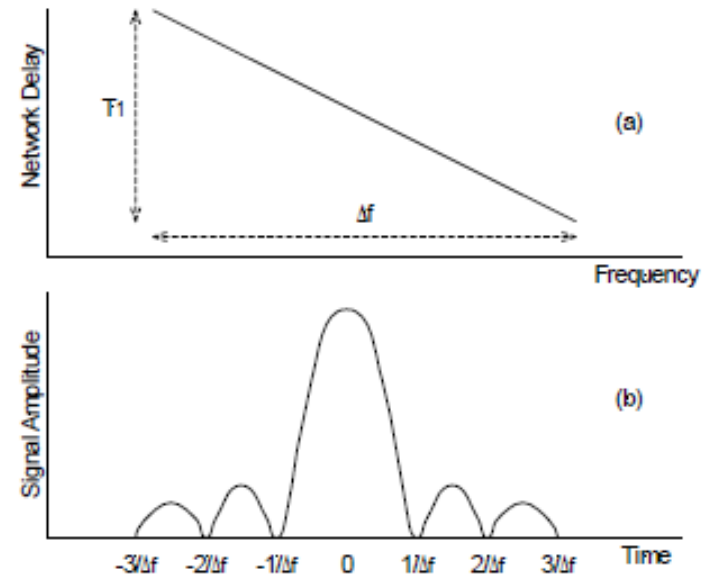

SAW pulse compression (IV)

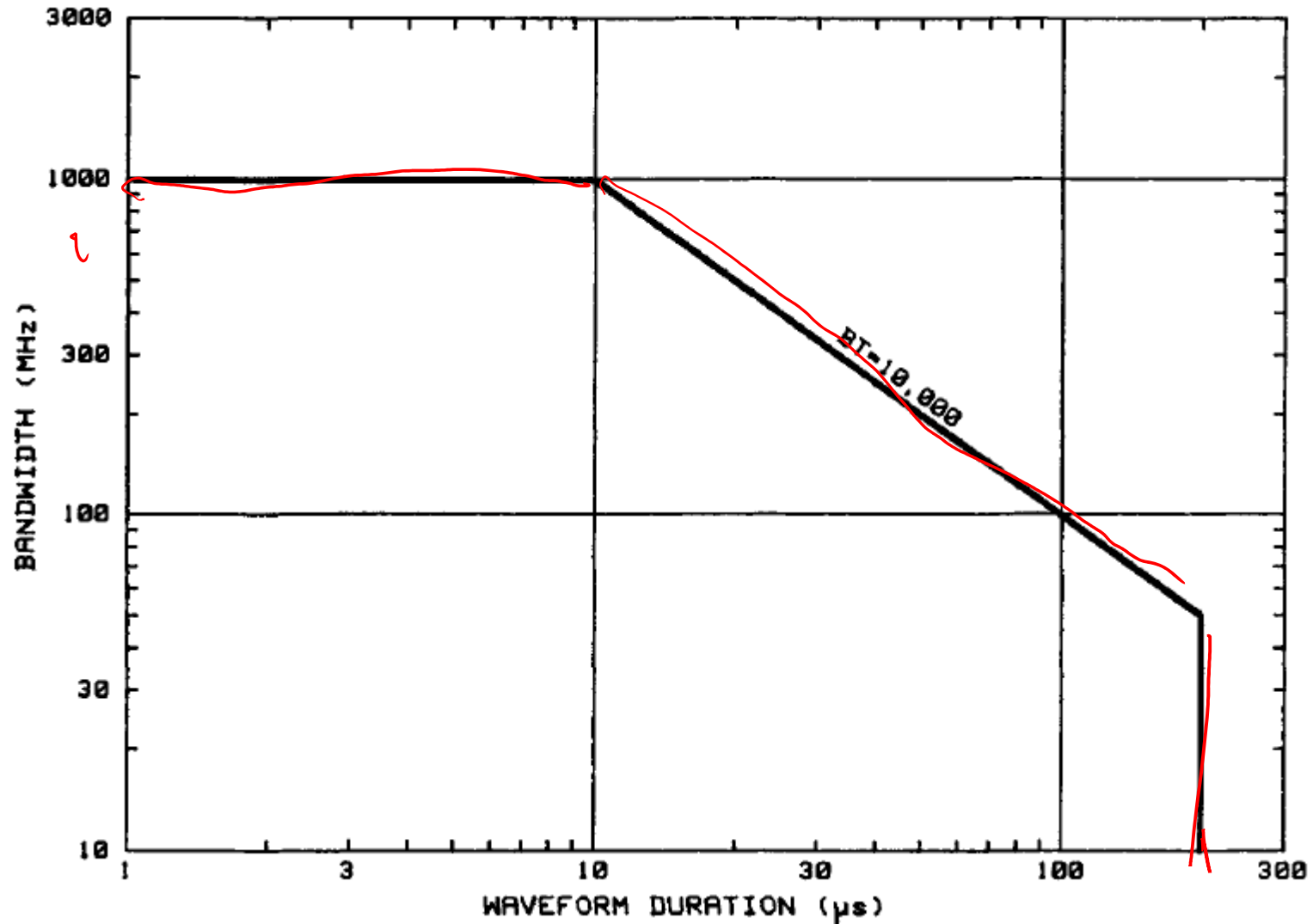

Chirp approximation and sidelobes

- Chirp autocorrelation
(matched filter output)

$$g(t) = \sqrt{\frac{B}{T}} \frac{\sin \left[\pi \frac{B}{T} (T - |t|) t \right]}{\pi \frac{B}{T} t}$$

- approximated with

$$g(t) \cong \sqrt{\frac{B}{T}} \frac{\sin [\pi B t]}{\pi \frac{B}{T} t} = \sqrt{B T} \operatorname{sinc} [\pi B t]$$

which is the Inverse Fourier Transform of
a rectangle in the frequency domain

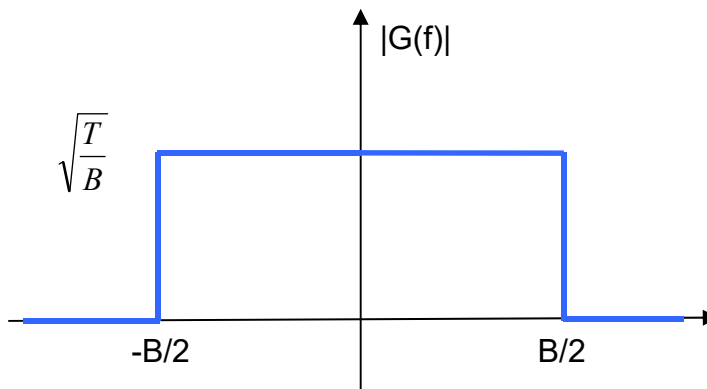

$$G(f) = \sqrt{\frac{T}{B}} \operatorname{rect}_B(f)$$

Distorsioni lineari (I)

Effetto delle distorsioni

- Il sistema reale sarà affetto da distorsioni (non sarà esattamente uguale a quello ideale): tutte le distorsioni di sistema possono essere sintetizzate in un filtro distorcente posto in cascata al filtro adattato ideale:

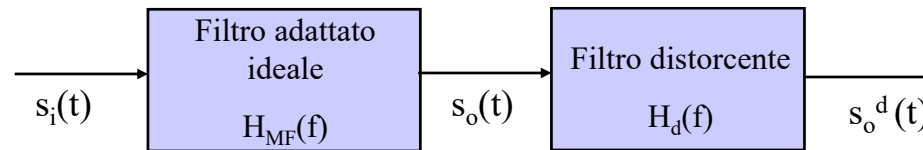

- Nell'ipotesi di piccole distorsioni la $H_d(f)$ può essere sviluppata in serie arrestandosi al primo termine

$$H_d(f) = A(f)e^{jB(f)} \rightarrow \begin{cases} A(f) = 1 + a_1 \cos(2\pi C_a f) \\ e^{jB(f)} = e^{jb_1 \sin(2\pi C_b f)} \cong 1 + jb_1 \sin(2\pi C_b f) \end{cases}$$

- a_1 : valore di picco della componente di ampiezza;
- b_1 : valore di picco della componente di fase;
- C_a : frequenza ripple di ampiezza;
- C_b : frequenza ripple di fase;

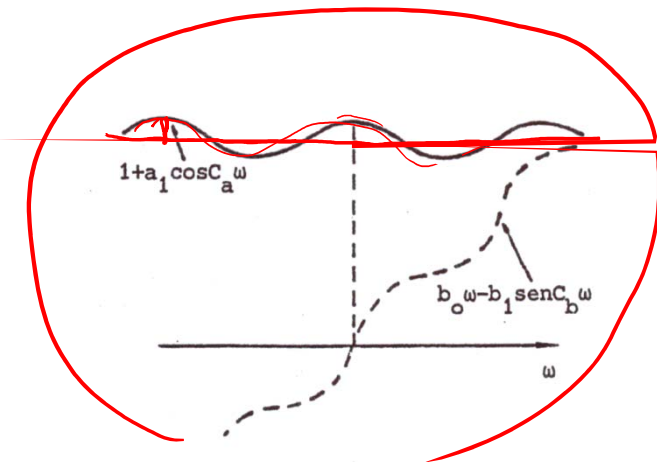

Distorsioni lineari (II)

- Il segnale di uscita distorto è dato da:

$$s_o^d(t) = s_o(t) + \frac{a_1}{2} s_o(t + C_a) + \frac{a_1}{2} s_o(t - C_a) \longrightarrow \text{effetto della distorsione di ampiezza;}$$

$$s_o^d(t) = s_o(t) + \frac{b_1}{2} s_o(t + C_b) - \frac{b_1}{2} s_o(t - C_b) \longrightarrow \text{effetto della distorsione di fase;}$$

**ECHI
APPAIATI**

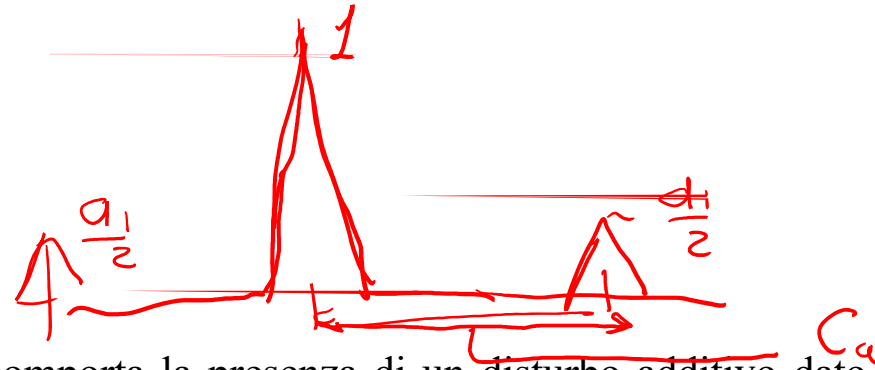

L'utilizzo di filtri reali anziché ideali comporta la presenza di un disturbo additivo dato dagli echi appaiati: tanto maggiore è a_1 & b_1 tanto maggiore è l'ampiezza dell'eco, tanto minore è C_a & C_b (ripple lento) tanto più gli echi appaiati compaiono vicini al segnale utile \Rightarrow dalle specifiche di dinamica si può ricavare la massima distorsione ammissibile (valore massimo a_1 & b_1).

Frequency domain weighting (I)

- To control sidelobes of the compressed waveform, amplitude weighting with appropriate taper functions can be used

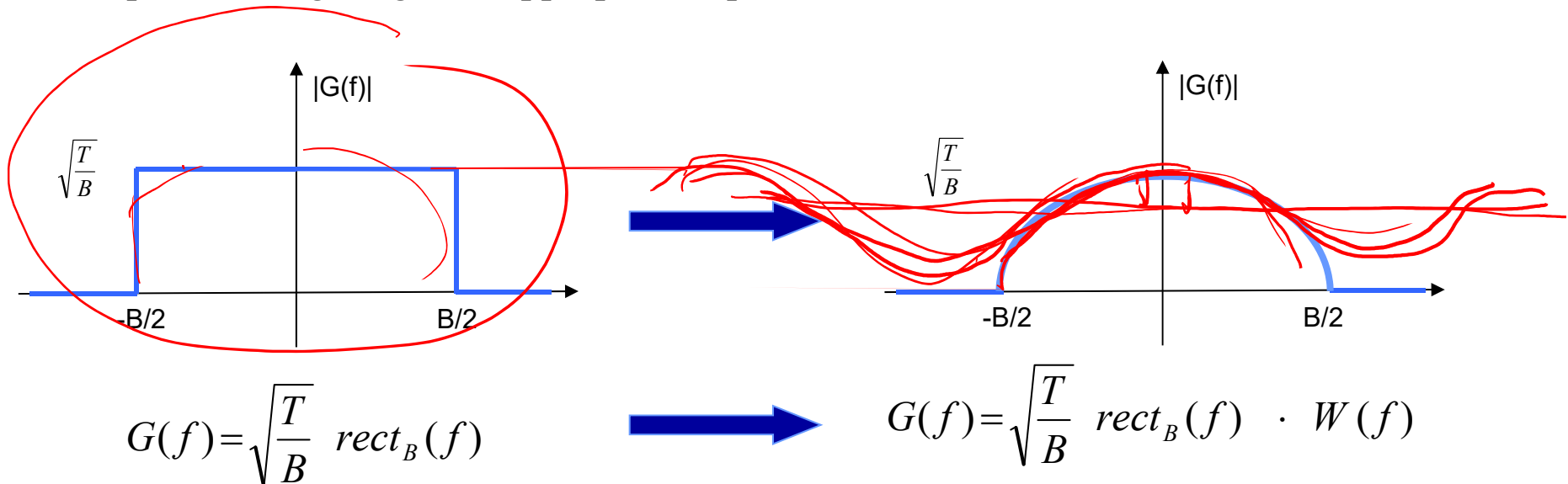

Taking the Inverse Fourier Transform, we have in time domain

$$g(t) \cong \sqrt{BT} \text{sinc} [\pi B t] \longrightarrow g(t) \cong \sqrt{BT} \text{sinc} [\pi B t] * w(t)$$

Frequency domain weighting (II)

- using appropriate taper function, allows to control sidelobes

For example

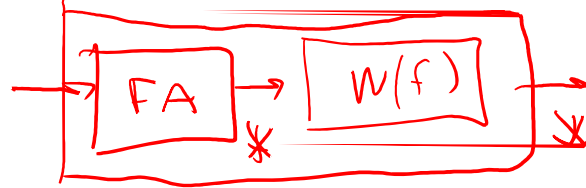

$$W(f) = (1 - k) + k \cos\left(\pi \frac{f}{B}\right)$$

$$w(t) = (1 - k) \delta(t) + \frac{k}{2} \delta\left(t - \frac{1}{2B}\right) + \frac{k}{2} \delta\left(t + \frac{1}{2B}\right)$$

Shifted replicas to remove sidelobes ...

$$g(t) \cong \sqrt{BT} \left\{ (1 - k) \operatorname{sinc} \left[\pi B t \right] + \frac{k}{2} \operatorname{sinc} \left[\pi B \left(t - \frac{1}{2B} \right) \right] + \frac{k}{2} \operatorname{sinc} \left[\pi B \left(t + \frac{1}{2B} \right) \right] \right\}$$

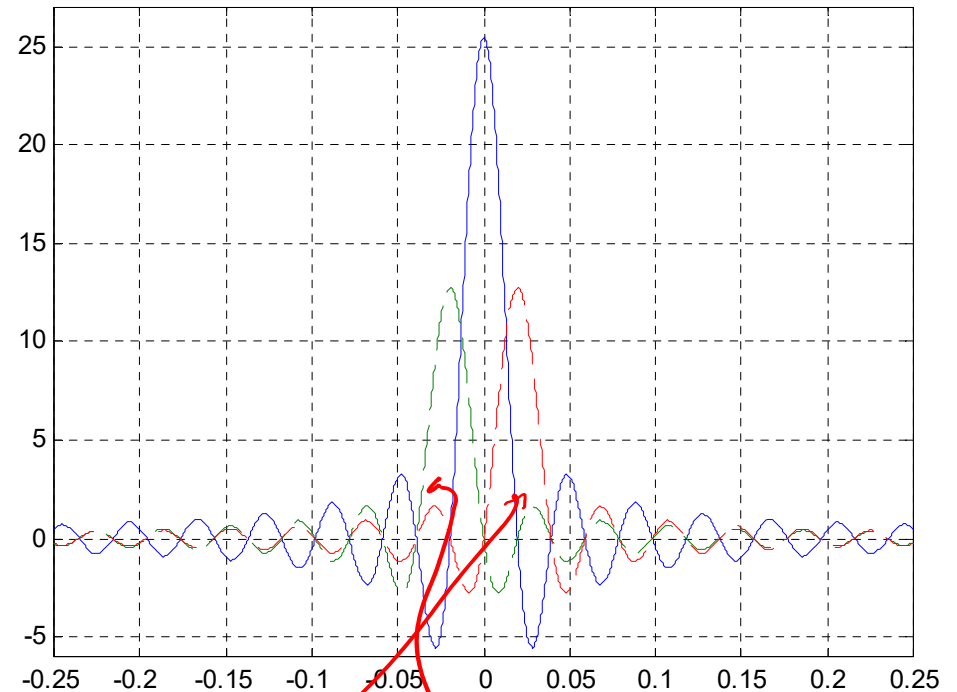

Analog vs. Digital domain operations

- usually compression is applied in the sampled domain
- Starting from an approximately rectangular chirp spectrum (sampled in frequency at $1/T$)

$$g(t_n) = \sum_{k=-\frac{(N-1)}{2}}^{\frac{(N-1)}{2}} e^{+j\frac{2\pi}{T}kt_n} = \frac{\sin\left[\frac{\pi}{T}(N-1)t_n\right]}{\sin\left[\frac{\pi}{T}t_n\right]}$$

Zeros of NUM: $t_n = \frac{kT}{N-1}$

Zeros of DEN: $t_n = kT$

which is the Inverse Fourier Transform of a rectangle in the frequency domain

$$g(t_n) = \sum_{k=-\frac{(N-1)}{2}}^{\frac{(N-1)}{2}} w_k e^{+j\frac{2\pi}{T}kt_n} \quad \text{with} \quad w_k = W\left(\frac{k}{T}\right)$$

Compressed waveform quality parameters

● **Side Lobe Level**

$$\text{SLL} = \frac{\text{Amplitude of the highest Side Lobe}}{\text{Main Beam Peak}}$$

● **Side Lobe Ratio**

$$\text{SLR} = (\text{SLL})^{-1}$$

$w_k \rightarrow$ taper coefficients

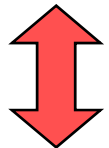

Generally achieved at the expense of:

● **Efficiency**

$$\eta = \frac{\left(\sum_{k=0}^{N-1} w_k \right)^2}{N \sum_{k=0}^{N-1} w_k^2}$$

● **3 dB resolution**

Taylor (1953):

- Symmetric weights yield lower sidelobes
- The sidelobe decay depends on the discontinuity in the aperture distribution and in its derivatives.
- A weight distribution with non-zero external elements (pedestal) is more efficient

Common used taper functions

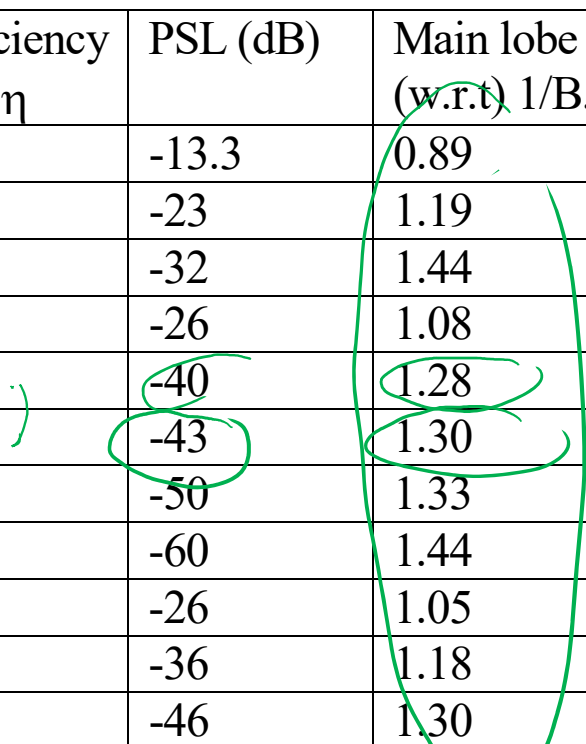

	Efficiency η	PSL (dB)	Main lobe width (w.r.t.) $1/B$.
Uniform	1	-13.3	0.89
Cosine	0.81	-23	1.19
Cosine squared (Hanning)	0.67	-32	1.44
Cosine squared on 10 dB pedestal	0.88	-26	1.08
→ Cosine squared on 20 dB pedestal	0.75	-40	1.28
Hamming	0.73	-43	1.30
Dolph Chebyshev	0.72	-50	1.33
Dolph Chebyshev	0.66	-60	1.44
Taylor $n\text{-bar}=3$	0.9	-26	1.05
Taylor $n\text{-bar}=5$	0.8	-36	1.18
Taylor $n\text{-bar}=8$	0.73	-46	1.30

Triangle (Bartlett) Window

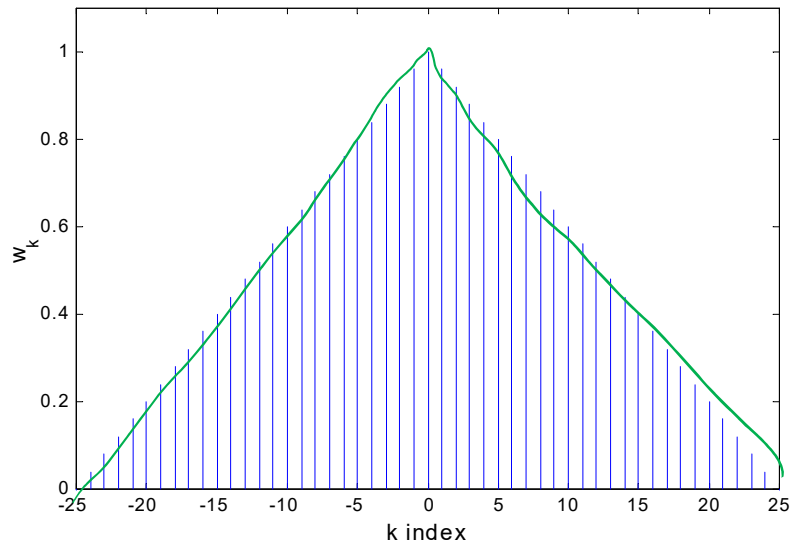

$$w_k = 1 - \frac{|k|}{(N-1)/2} \quad k = -\frac{N-1}{2}, \dots, -1, 0, 1, \dots, \frac{N-1}{2}$$

$$g(t_n) = \frac{2}{N} \left[\frac{\sin\left[\frac{\pi N}{T} \frac{t_n}{2}\right]}{\sin\left[\frac{\pi}{T} t_n\right]} \right]^2$$

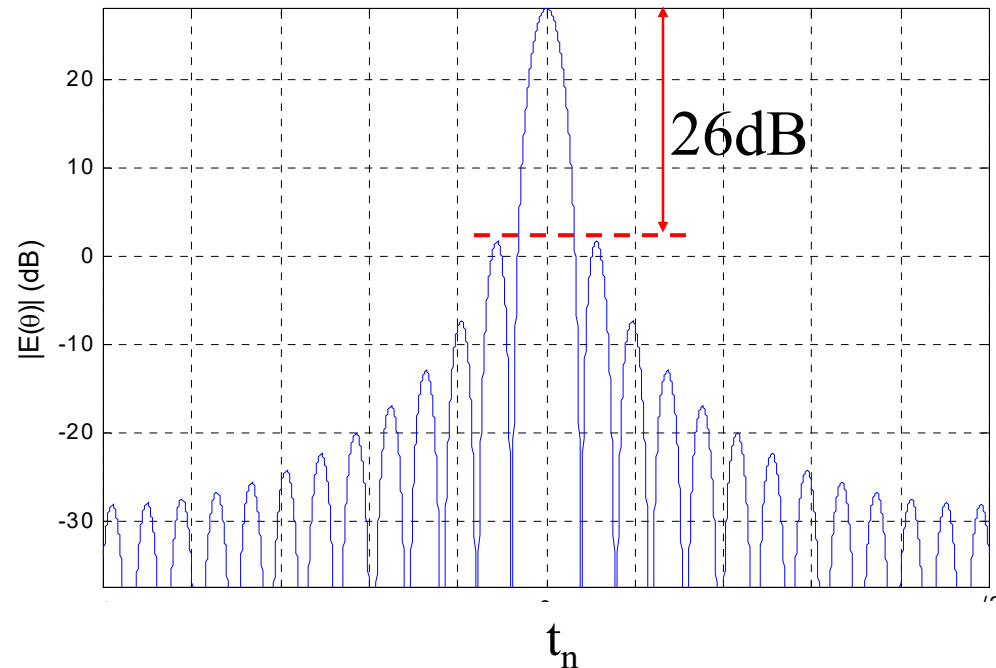

- Main Beam width (between zero crossing) is twice that of the uniform window
- Zeros of order 2 in the Fourier Transform
- $SLR \approx 26\text{dB} = 2 * 13\text{dB}$
- Decay $SL \propto 1/x^2$ (-12dB/oct) (discontinuity in the first derivative)

$\cos^\alpha(x)$ Windows \rightarrow Hanning Window ($\alpha=2$)

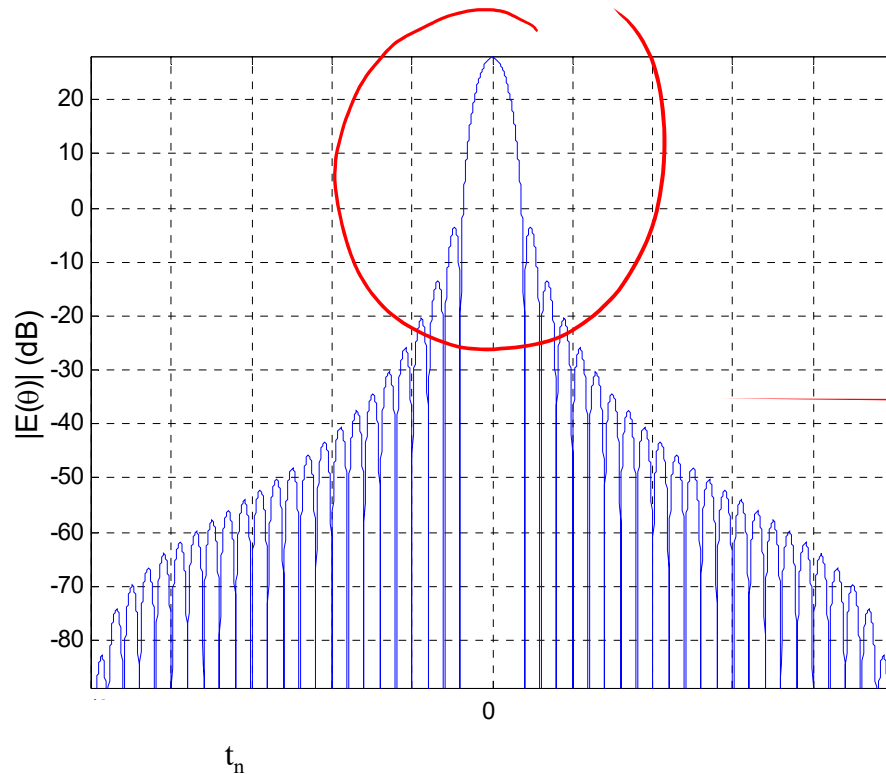

- It does not require extra memory and is controlled by a single parameter.
- Wide enlargement of the main lobe
- Low efficiency: $\eta=0.67$
- **SLR=32dB**
- SL Decay $\propto 1/x^3$ (-18dB/oct)
(discontinuity in the second derivative)

$K =$

$$\cos^2(\dots)$$

$$\frac{1}{2} + \frac{1}{2} \cos(\dots)$$

Hamming Window

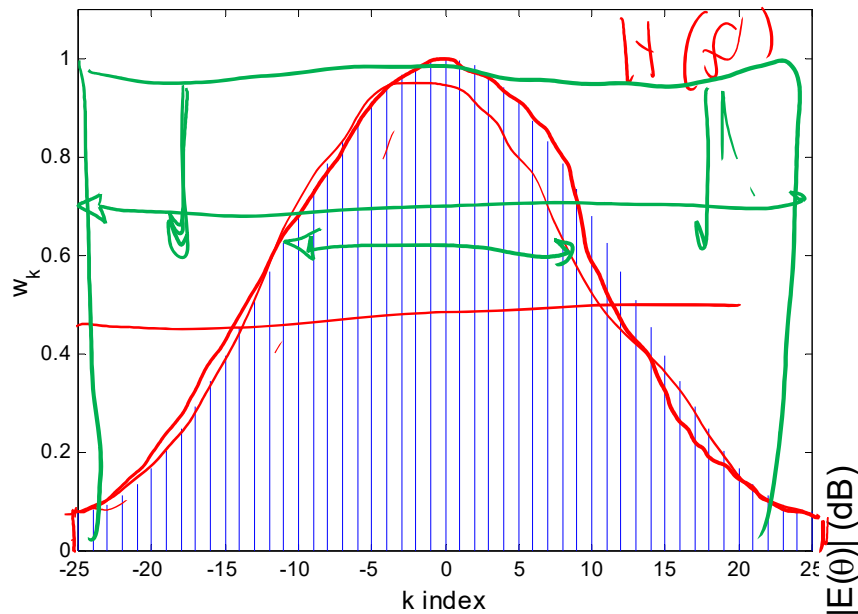

- SLR=43dB
- SL Decay $\propto 1/x$ (-6dB/oct)
(discontinuity at the extremes)

- large attenuation of the first SL of the original compressed waveform
- Better efficiency than Hanning: $\eta=0.73$

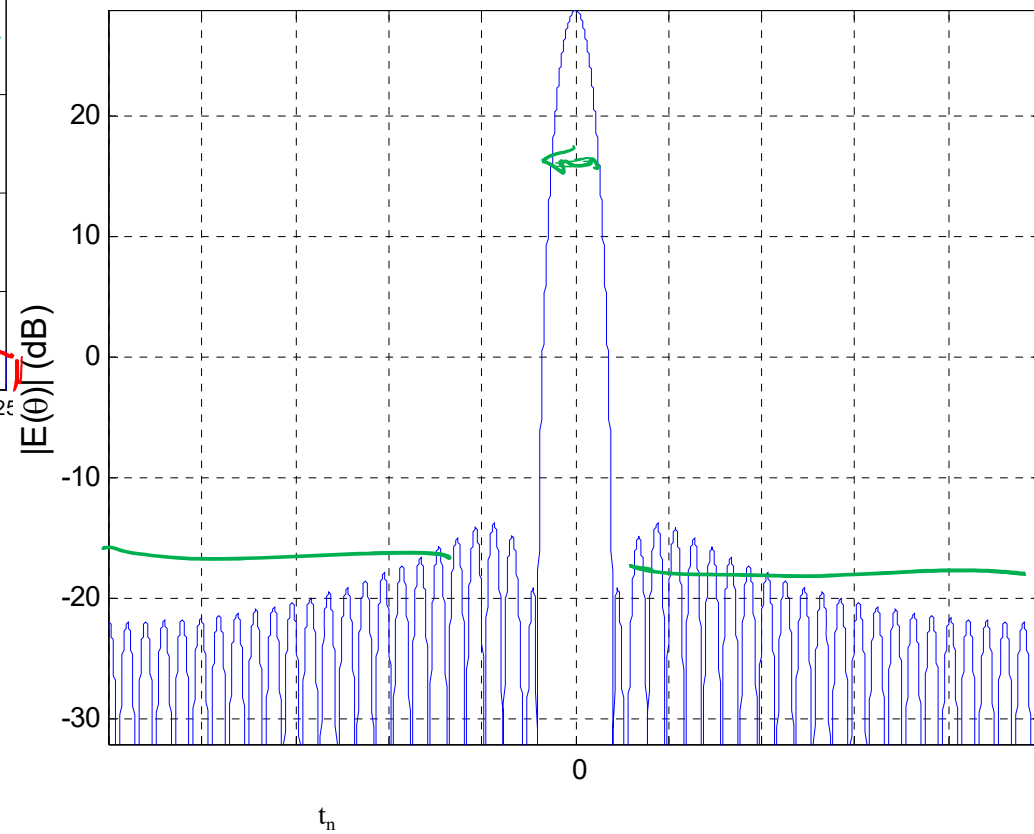

Dolph-Chebyshev Window

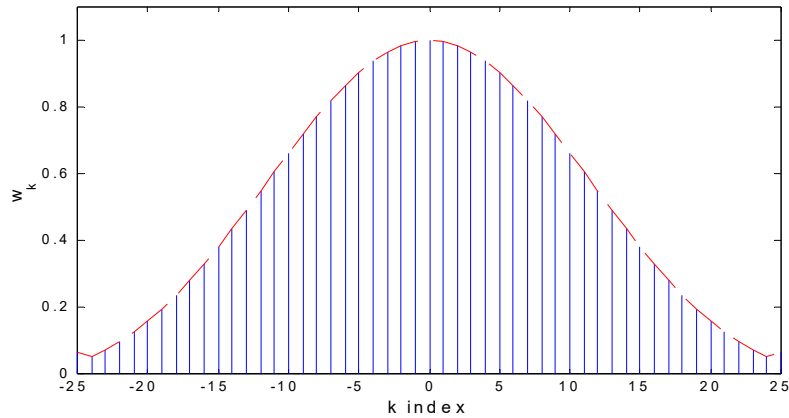

SLR=50dB

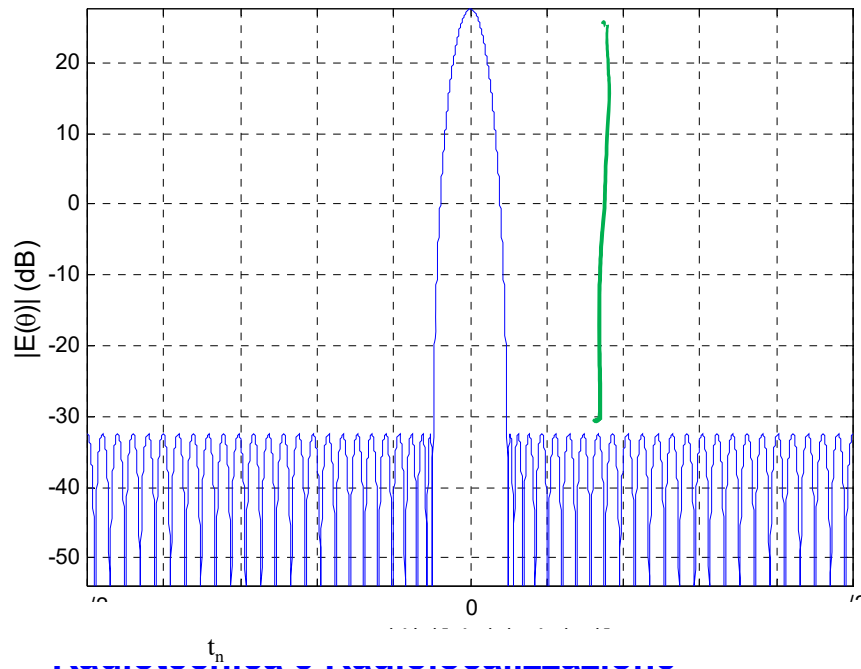
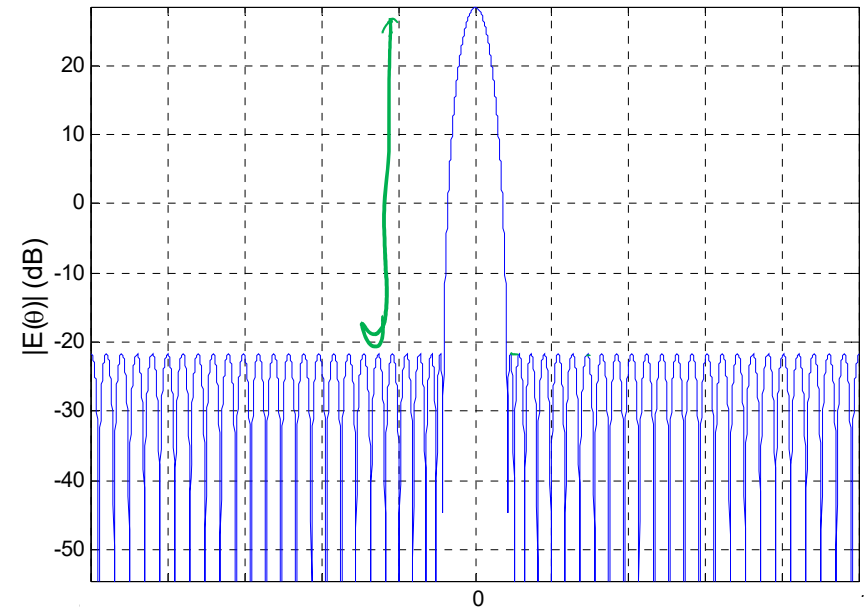

SLR=60dB

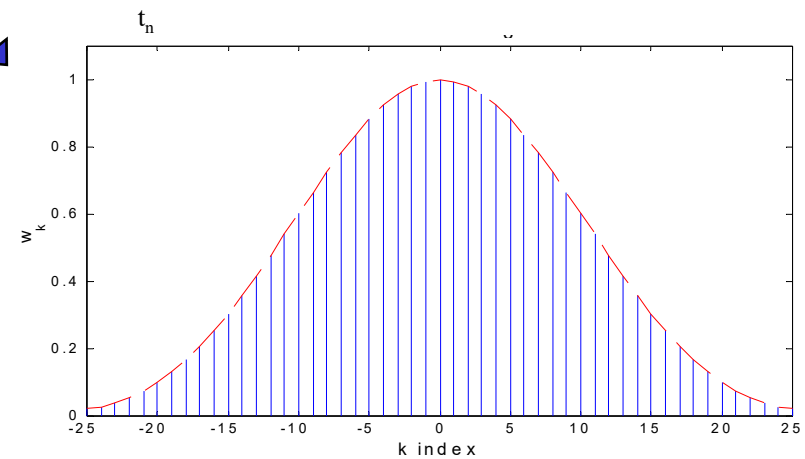

Dolph-Chebyshev Window (2)

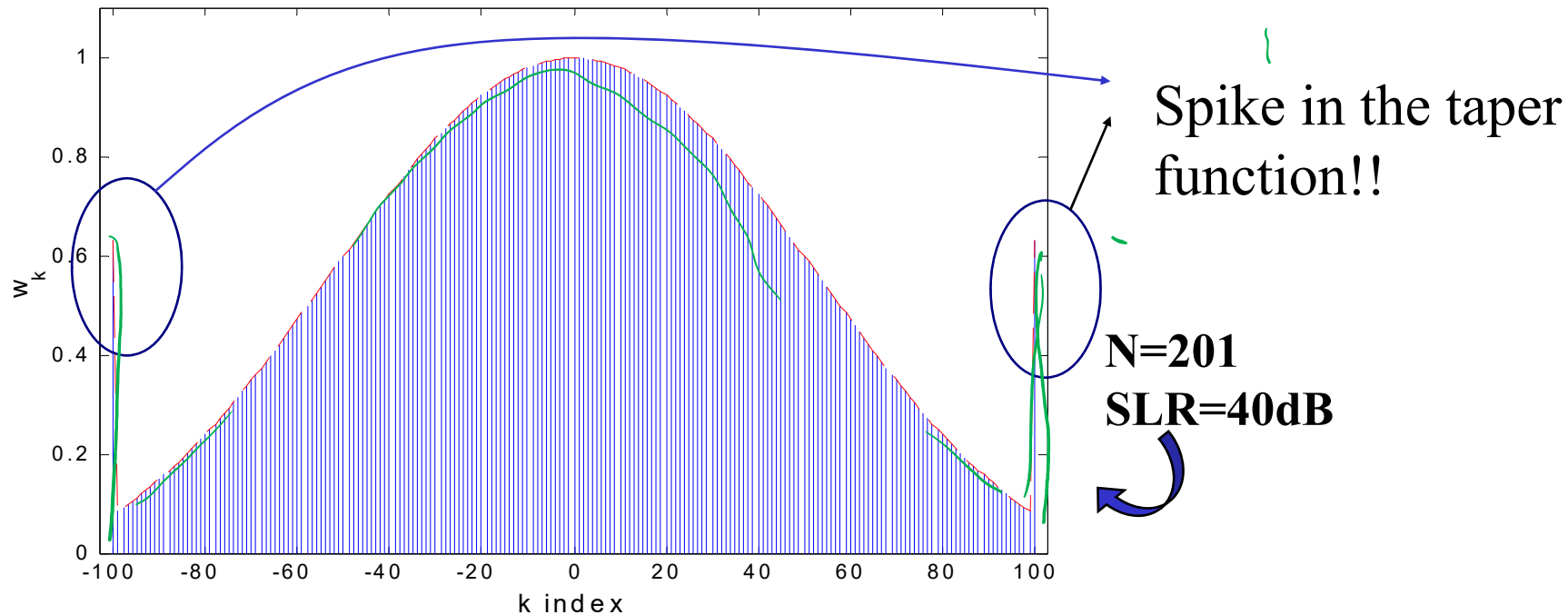

For this reason, such taper function is not used in practice.

The Taylor taper function is studied to solve such undesired feature, while keeping the nice properties of the Dolph-Chebyshev solution.

Taylor n-bar Window

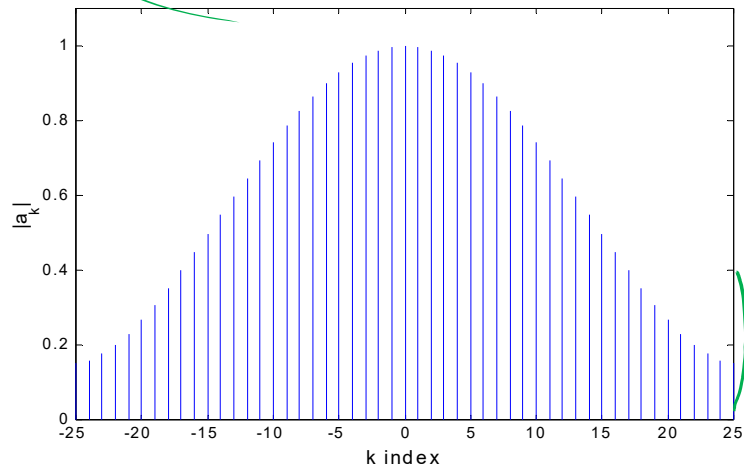

$\bar{n} = 5$
SLR=36dB

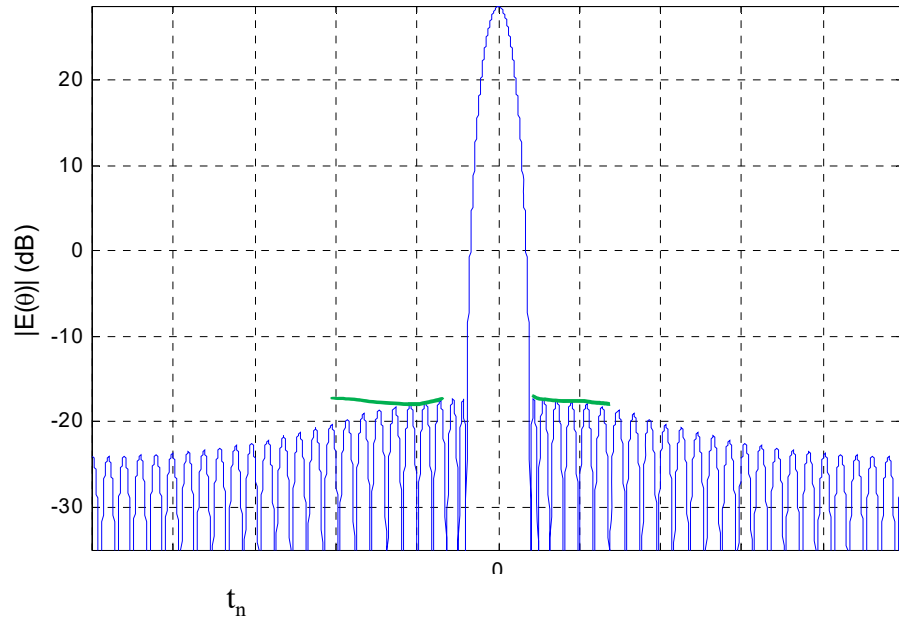
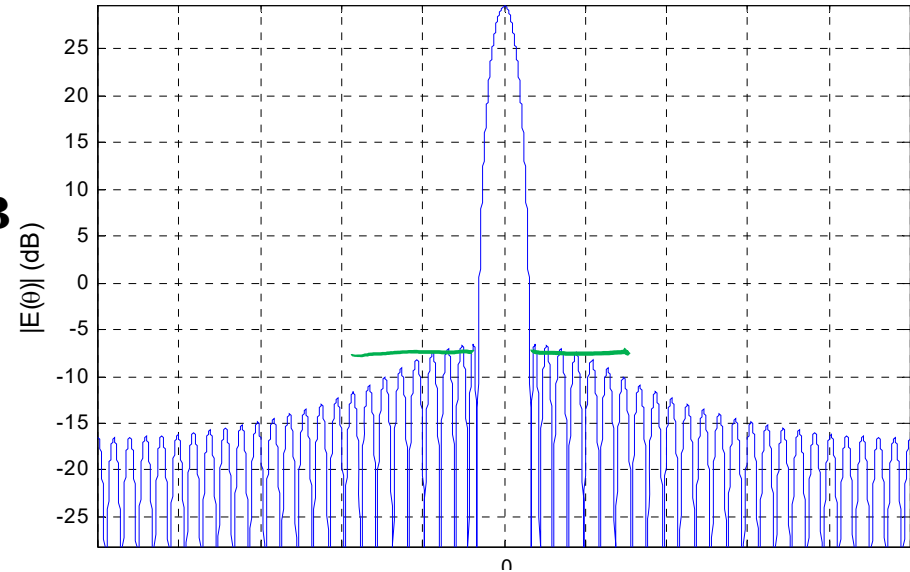

$\bar{n} = 8$
SLR=46dB

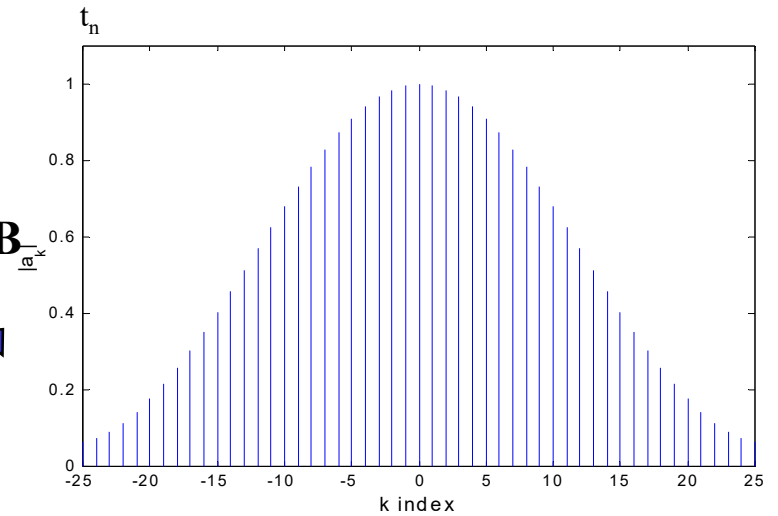

Taylor n-bar Window (2)

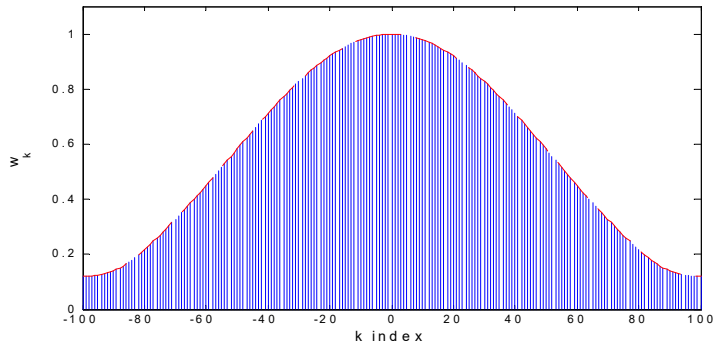

$\bar{n} = 10$
 $N = 201$
 $SLR = 40\text{dB}$



No spikes!

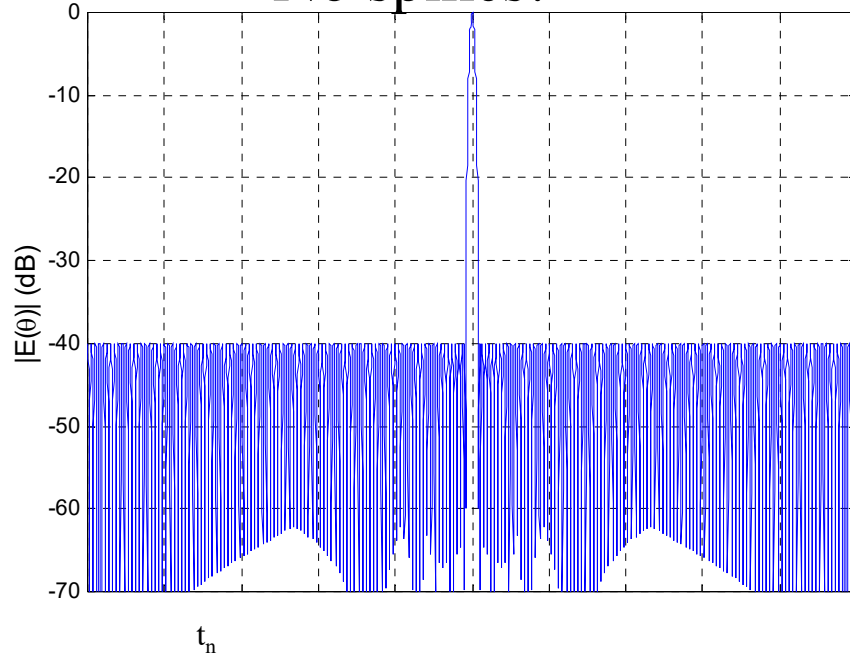

**Chebyshev
 pattern
 -40dB**

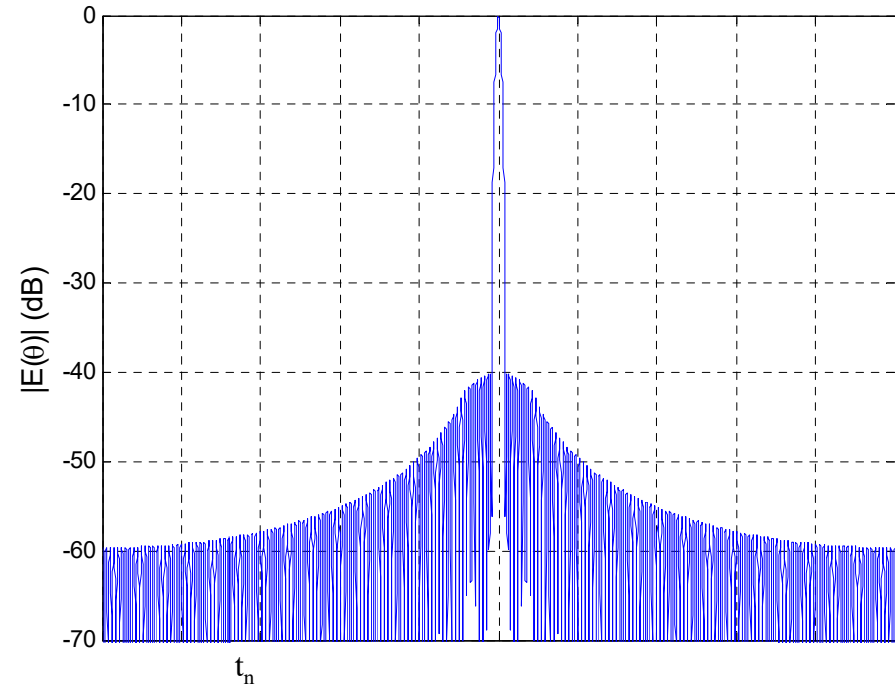
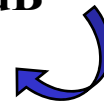

- Good approximation for the first SL
- SL asymptotic decay $\propto 1/x$
- Main beam widening
- n cannot be too small for an assigned SLR, but large n values yield implementation problems