

Channelopathies

- Long QT syndromes Type 1 and 2 : LQT1 and LQT2: delayed K^+ channel
- Long QT syndrome type 3: LQT3: Na^+ channel
- Epilepsy: Voltage-gated Ca^{2+} channel
- Diabetes Mellitus: **ATP-sensitive** K^+ channel
- Cystic fibrosis: CFTR, Cl^- channel

Ion Channels and Channelopathies

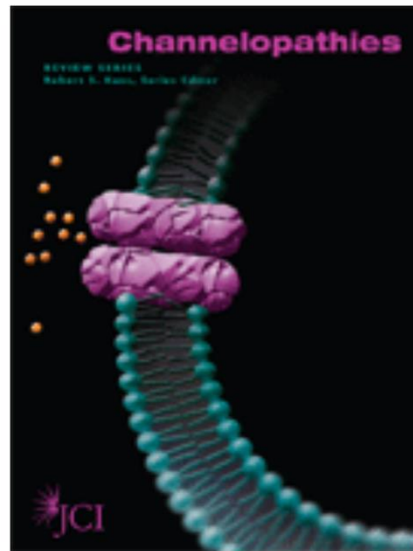

J Clin Invest. 2005;115(8)
review series

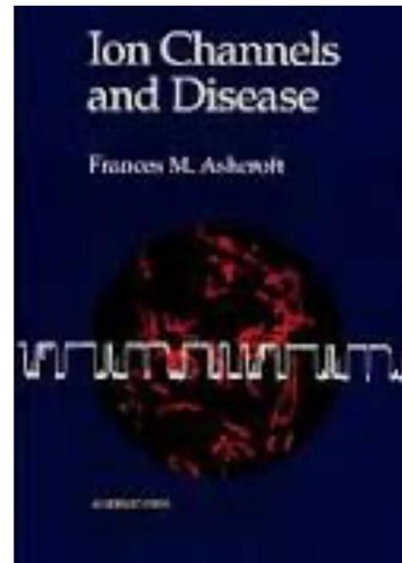

Frances M. Ashcroft
2005

Four Milestones in Ion Channel Research

1. Ionic conductance

Noble 1963 (Physiol/Medicine)



Alan L. Hodgkin



Andrew F. Huxley

2. Patch clamp methodology

Noble 1991 (Physiol/Medicine)



Erwin Neher



Bert Sakmann

3. Channel cloning sequencing (ACh receptor, Na, Ca channels)



Japan Academy
Prize 1985

Shosaku Numa (沼 正作)

4. K channel structure

Noble 2003 (Chemistry)

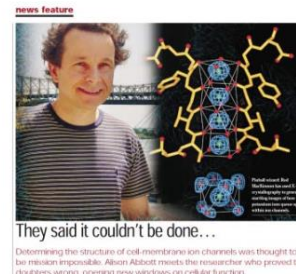

Rod MacKinnon

>340 human genes code for Ionic Channels:

muscular and nervous excitation

hormonal secretion

cell proliferation

signal transduction

learning and memory

Blood pressure

hydro-salt balance

cell death

Mutations in > 60 human genes that code for Ionic Channels have been associated with diseases

CHANNELOPATHIES = diseases resulting from the failure of ion channels (mutations in genes coding for ion channels or accessory regulatory subunits)

Channelopathies?

1. **Definition:** Disorders of ion channels or ion channel disease

Diseases that result from defects in ion channel function. Mostly caused by mutations of ion channels.

2. **Channelopathies can be inherited or acquired:**

a. Inherited channelopathies result from mutations in genes encoding channel proteins (major)

b. Acquired channelopathies result from *de novo mutations*, actions of drugs/toxins, or autoimmune attack of ion channels

- Drug/Toxin - *e.g. Drugs that cause long QT syndrome*

3. **Increasingly recognized as important cause of disease (>30 diseases).**

4. **Numerous mutation sites may cause similar channelopathy**

e.g. cystic fibrosis where >1000 different mutations of CFTR described

original sequence

codon

amino acid

ACC ATC GGT TAT GGC
T I G Y G

point mutation

codon

amino acid

ACC ATC **AGT** TAT GGC
T I **S** Y G

Nonsense mutation

codon

amino acid

ACC ATC AGT **TAG** GGC
T I G *

frameshift

codon

amino acid

ACC **GAT** CGG TTA TGG C
T **D** R L W

Mutations alter the structure and function of ion channels

Loss of function mutations:

lack of protein synthesis

failed or incorrect insertion in the membrane

destruction of ligand binding sites

or proteins / accessory subunits
("modulation")

Gain of function mutations

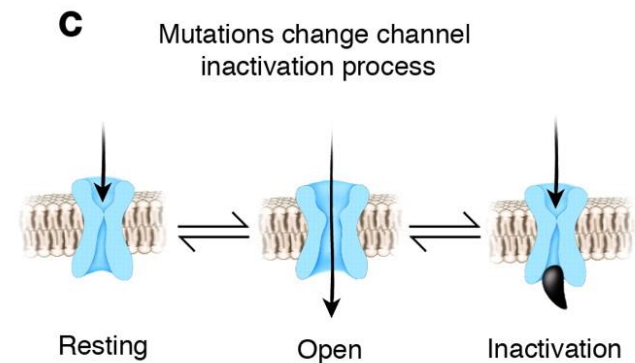
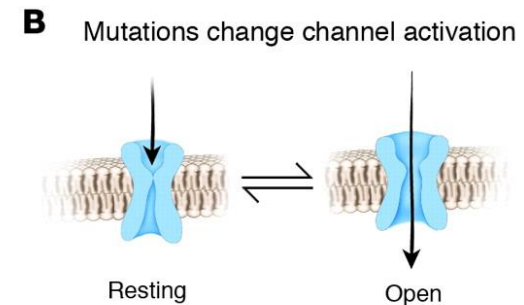
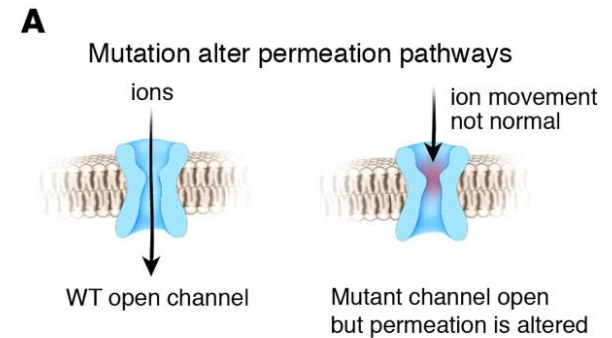

Molecular Mechanisms of Channel Disruption

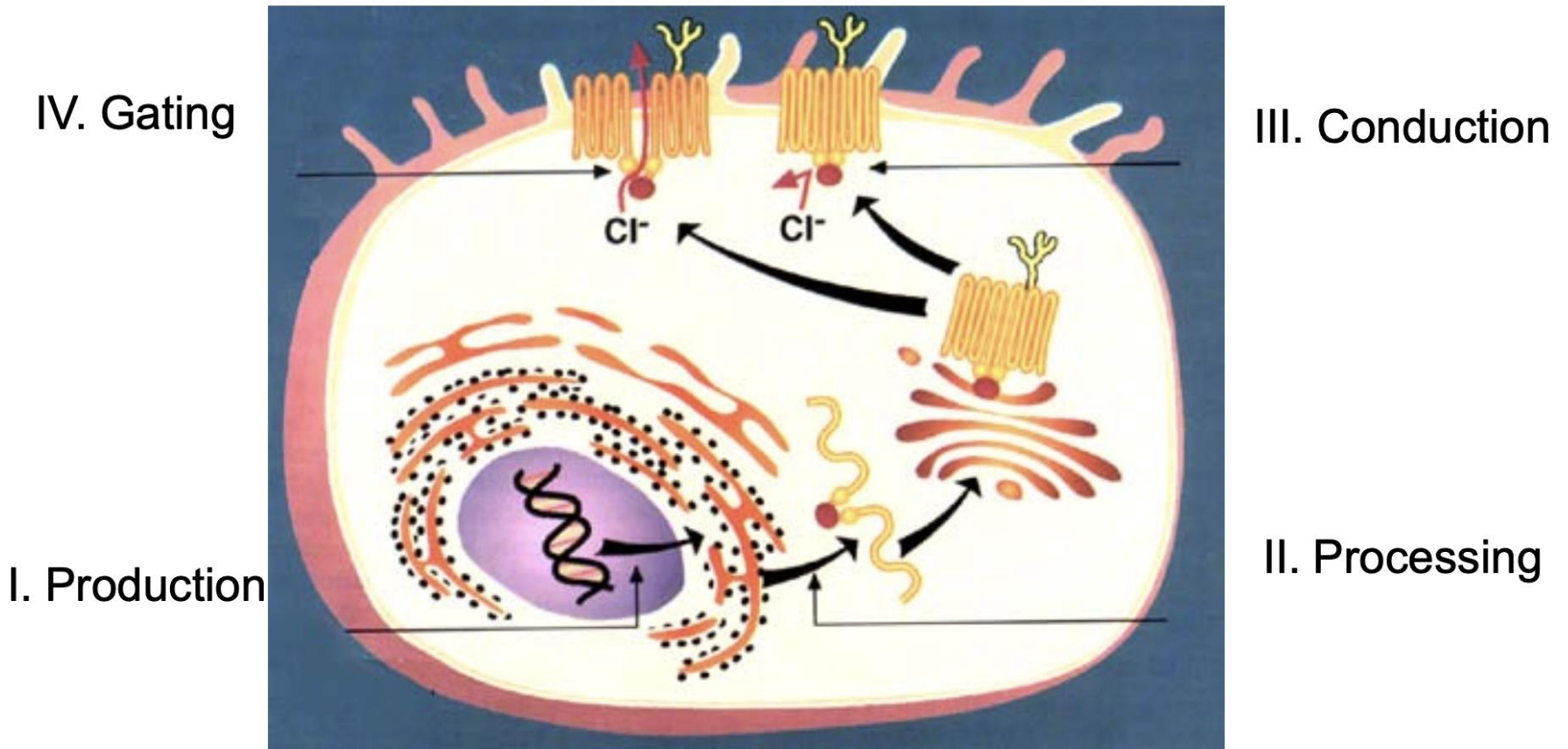

Consequences of Ion Channel Mutations

- Mutation of ion channel can alter
 - Activation
 - Inactivation
 - Ion selectivity/Conduction
- Abnormal gain of function
- Loss of function

Pathologies of ion channels

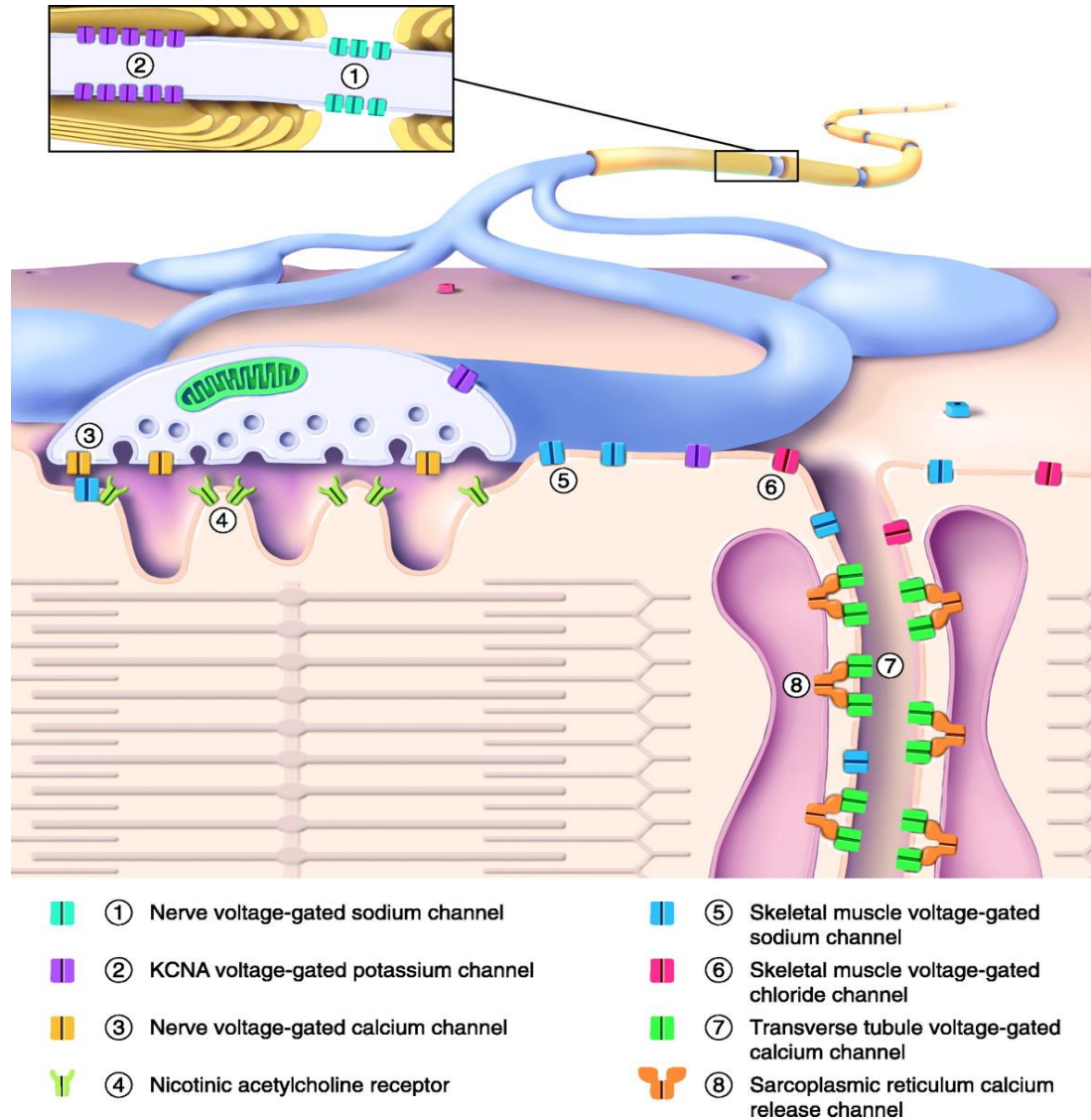

Cooper, Edward C. and Jan, Lily Yeh (1999) Proc. Natl. Acad. Sci. USA 96, 4759-4766

Figura 3.7

I canali ionici di membrana. I canali ionici sono costituiti da proteine che attraversano la membrana, unite tra loro a formare un poro. In questo esempio il canale proteico è costituito da cinque subunità polipeptidiche. Ciascuna subunità è dotata di una regione superficiale idrofobica (ombreggiata) che si unisce efficacemente al doppio strato fosfolipidico.

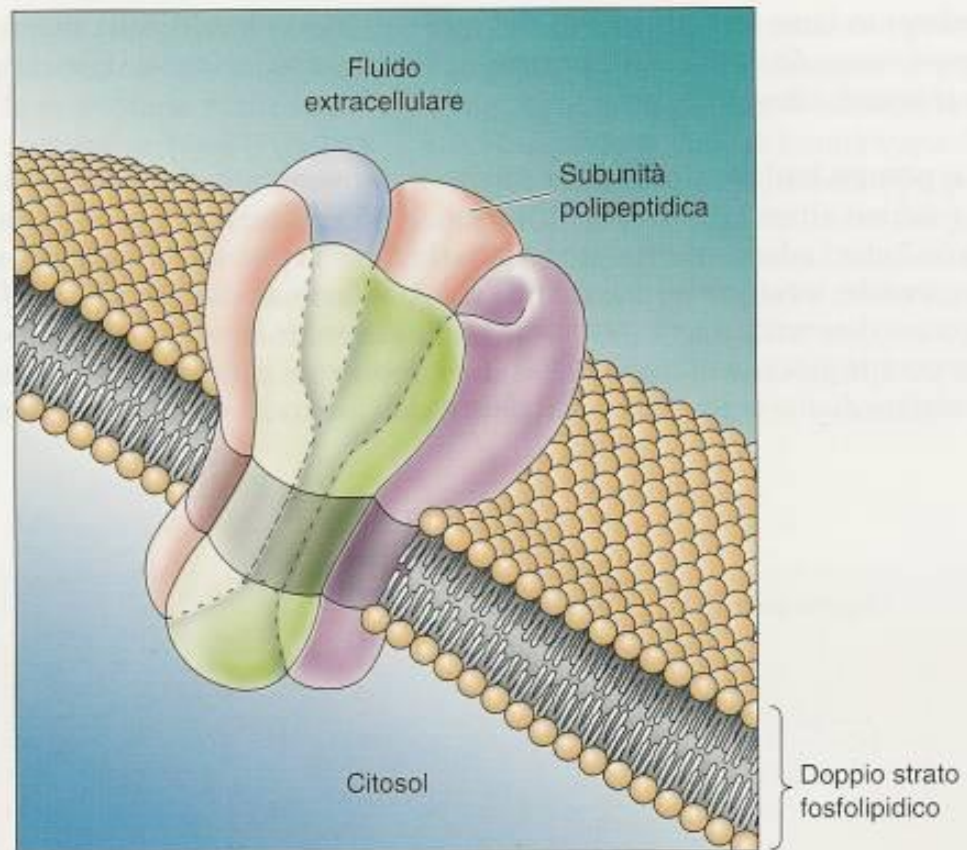

Properties of Ionic Channels.

- **Selectivity** = ability to discriminate between one ionic species and another

dimension

charge

- **Gating** = transition process between an "open" and "closed" state

Ligand-gated channel

Voltage-gated channel

Temperature

Mechanical Stress

- **Modulation (phosphorylation)**

Gating = transition process between an "open" and "closed" state

Ligand-gated channel

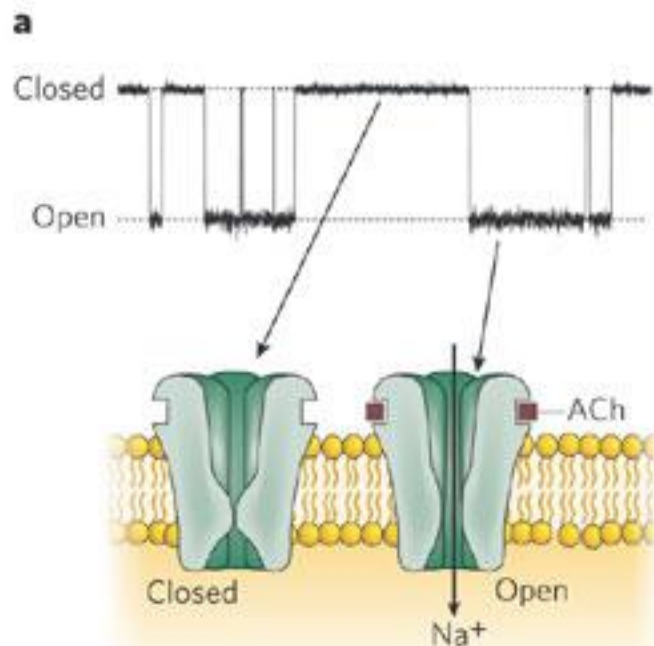

Voltage-gated channel

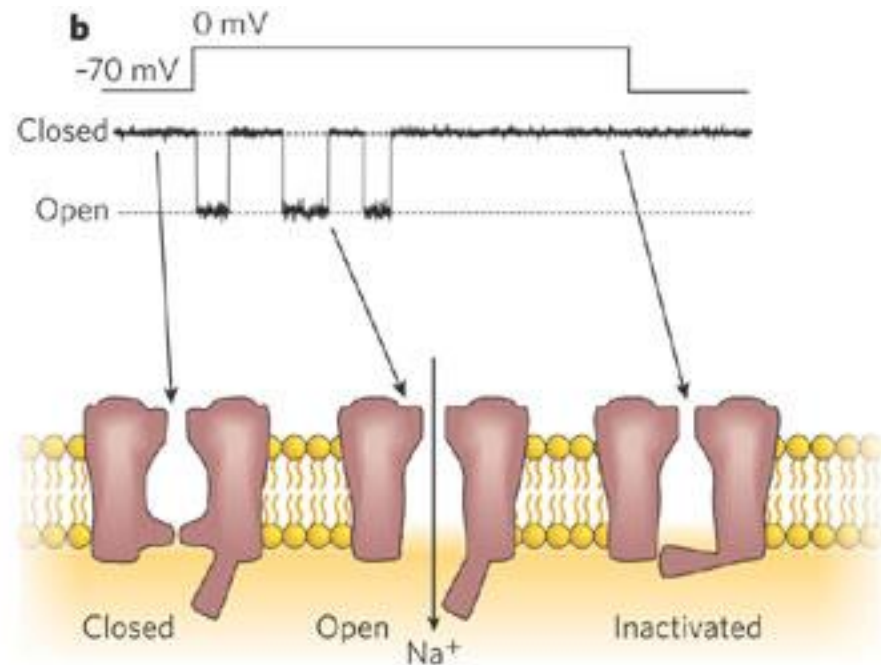

Mutations alter the structure and function of ion channels

Loss of function mutations:

lack of protein synthesis

failed or incorrect insertion in the membrane

destruction of ligand binding sites

or proteins / accessory subunits
("modulation")

Gain of function mutations

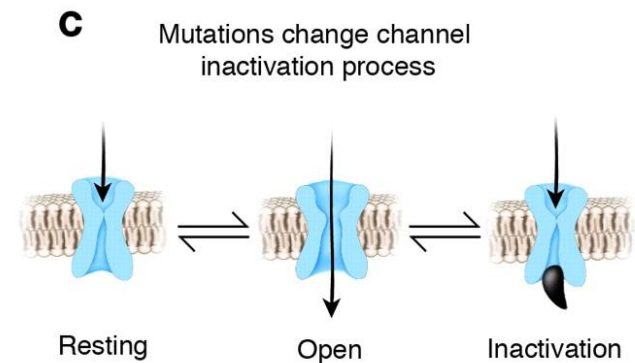
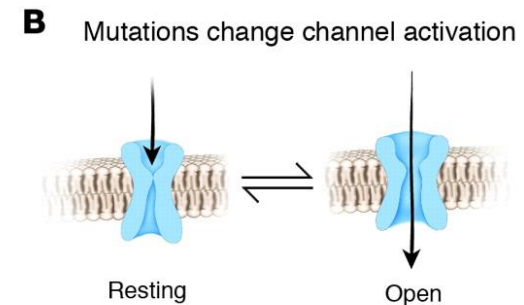
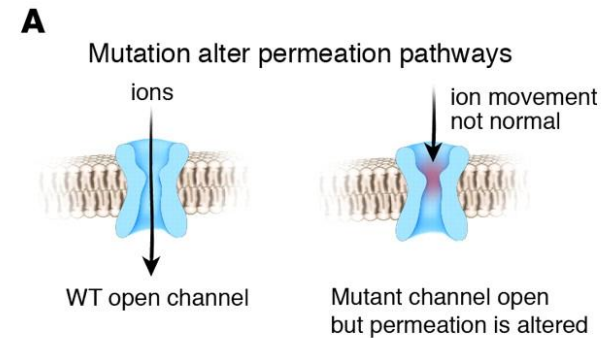

Cardiac Channelopathies

- ➔ • Long QT Syndrome (types 1-12, various genes)
- Short QT Syndrome (Kir2.1, L-type Ca²⁺ channel)
- Brugada Syndrome (I_{to}, Na⁺, Ca²⁺ channels)
- Catecholaminergic Polymorphic Ventricular Tachycardia (CPVT) (RyR2, SR Ca release)

Long QT syndrome

ECG and QT interval

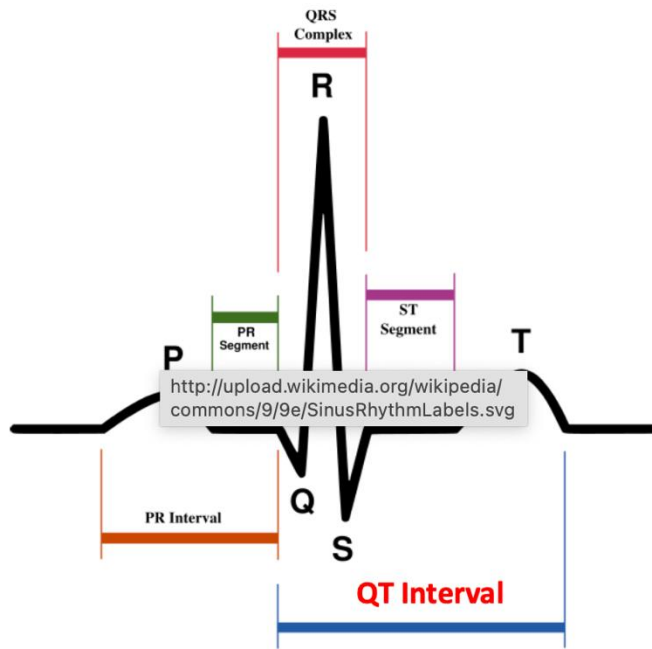
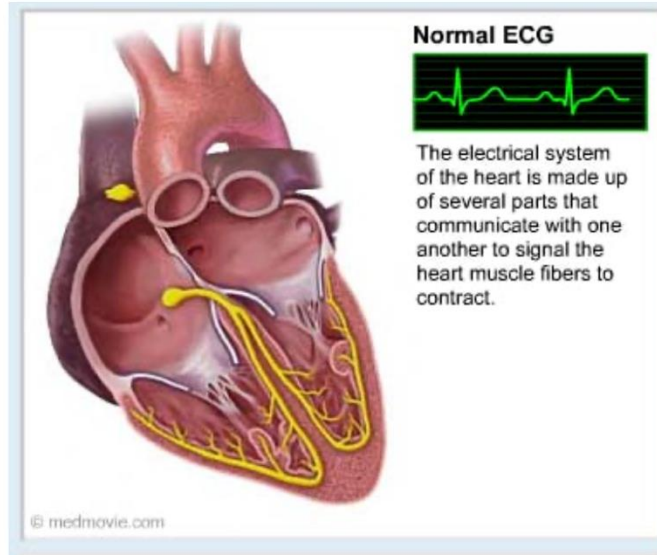

$$QT_c = \frac{QT \text{ interval}}{\sqrt{R-R \text{ interval}}}$$

Bazett's Formula:

FYI: ECG Recording 120 Years Ago

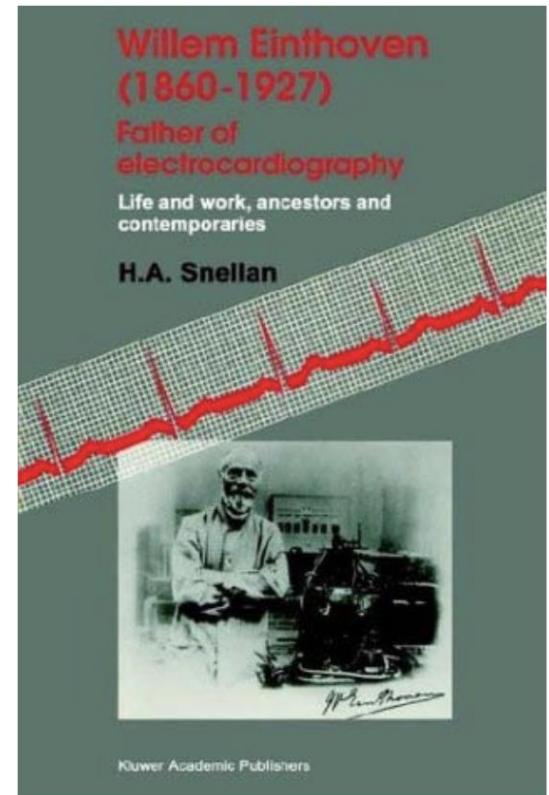
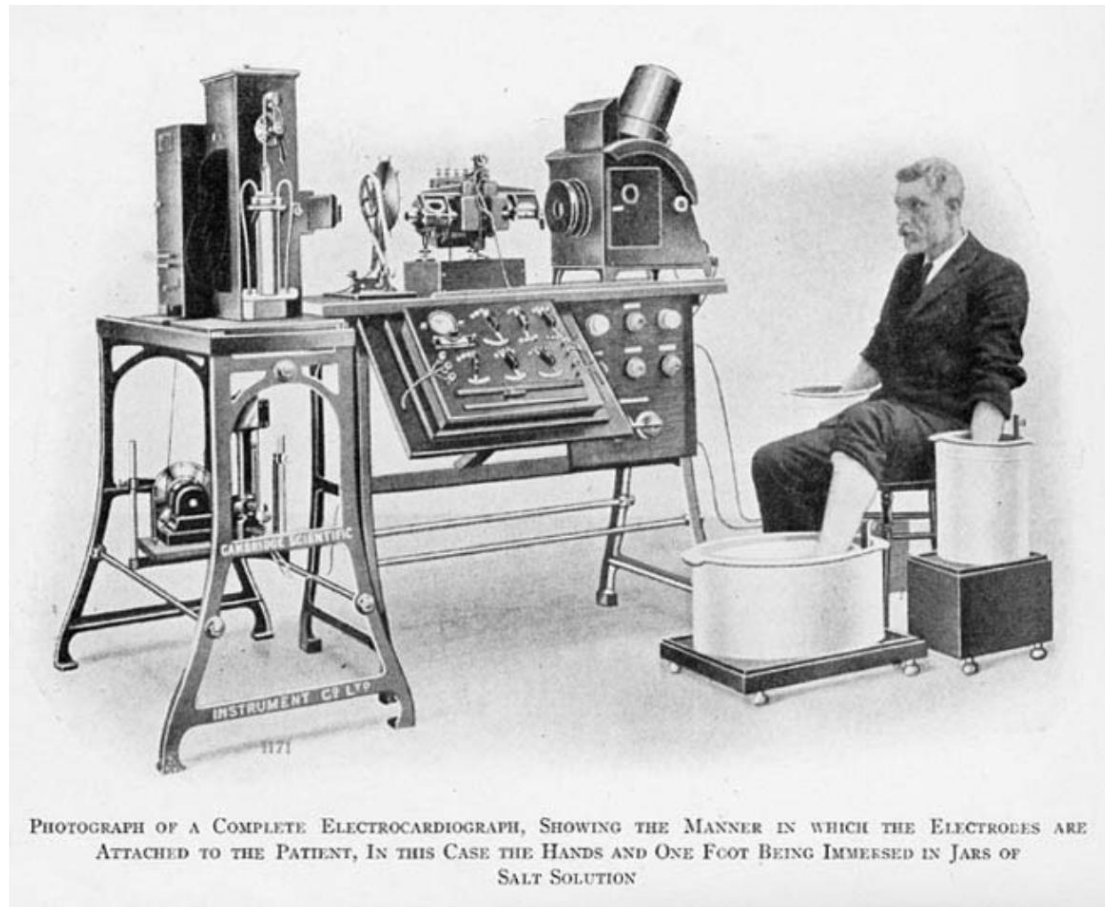

First recorded in 1887

In order to conduct the weak current of the heart's electrical activity, Einthoven used electrolyte (saline-filled) tubs ["E" in photo] as *electrode* contacts to each of three limbs, the right arm, the left arm, and the left foot, respectively.¹⁰ He chose two of these limb electrodes to monitor each *lead*, making one electrode positive and the other electrode negative to record each of his three classic *bipolar limb leads*. He named these bipolar limb leads *Lead I* (left arm positive, right arm negative), *Lead II* (left foot positive, right arm negative), and *Lead III* (left foot positive, left arm negative). Note that the original string galvanometer consisted of massive equipment that filled a room,

FYI: ECG Recording 120 Years Ago



AP Correlation to ECG Waveform

- **P wave:** Electrical activation (depolarization) of the atrial myocardium.
- **PR segment:** This is a time of electrical quiescence during which the wave of electrical excitation (depolarization) passes through mainly the AV node.
- **QRS wave:** Depolarization of the ventricular myocardium.
- **T wave:** Ending of ventricular myocardium repolarization
- **ST segment:** Ventricular repolarization

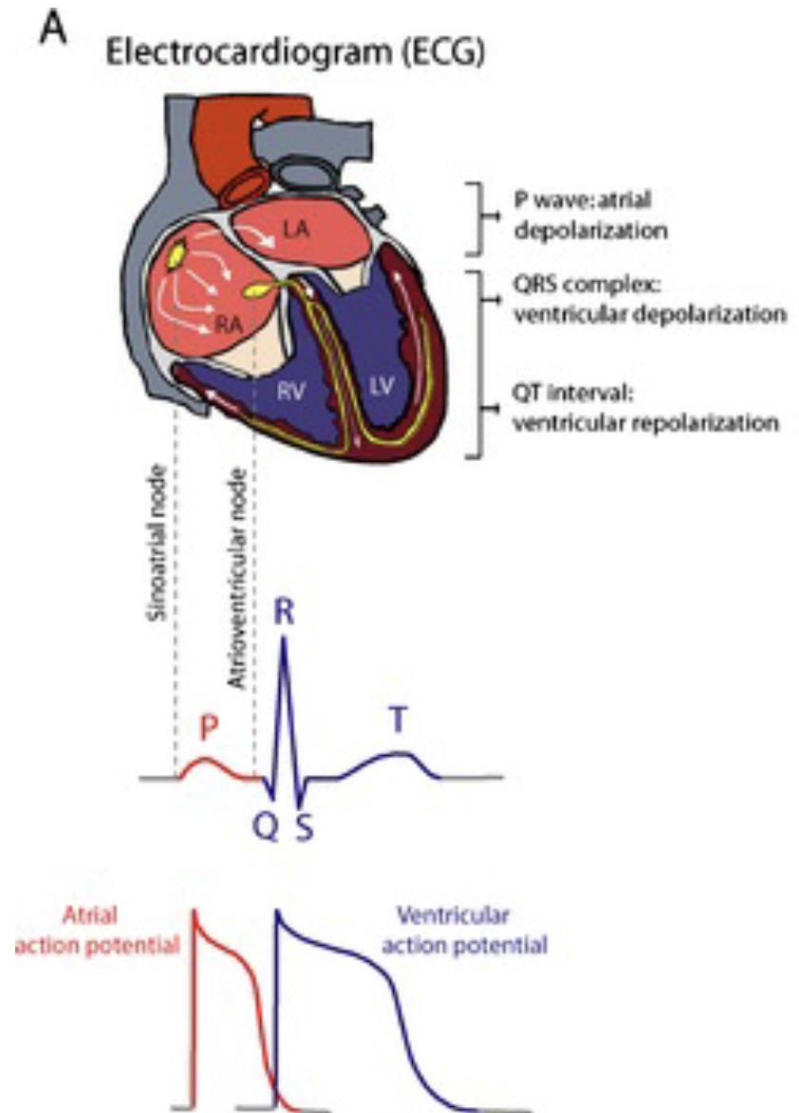

CARDIAC ACTION POTENTIAL

Different types of cells are distinguished: nodal (sinus-atrial node and atrioventricular node); conduction (His bundle and Purkinije fibers, common or working) The electrical and membrane mechanisms are similar to those already seen: we will focus mainly on the differences.

Heart cardiomyocytes: potential in 5 phases

0 - rapid depolarization for opening of voltage-gated sodium channels

1 - partial short repolarization due to transient increase in chloride and potassium conductance

2 - plateau: stable potential on slightly positive values for about 0.2 s; due to the increase in calcium conductance (opening of "slow channels") and reduction of K conductance

3 - repolarization due to progressive increase in potassium conductance and closure of slow channels; repolarization due to progressive increase in potassium conductance and closure of slow channels;

4 - resting potential, stable at -90 mV.

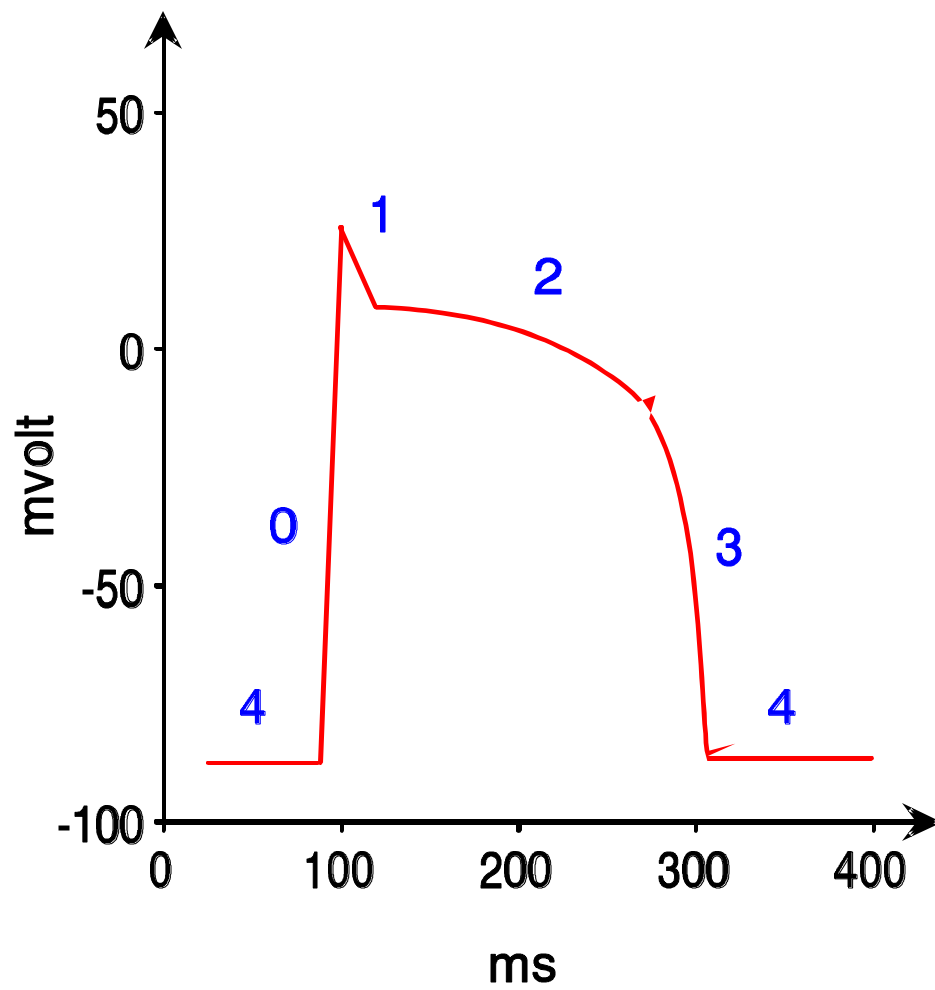

During the plateau a calcium current occurs, very important for the electromechanical coupling and for the regulation of contractility

Changes in excitability during action potential:
refractory periods. The mechanical response
appears during the potential and has
approximately the same duration: the heart
can not be tetanized

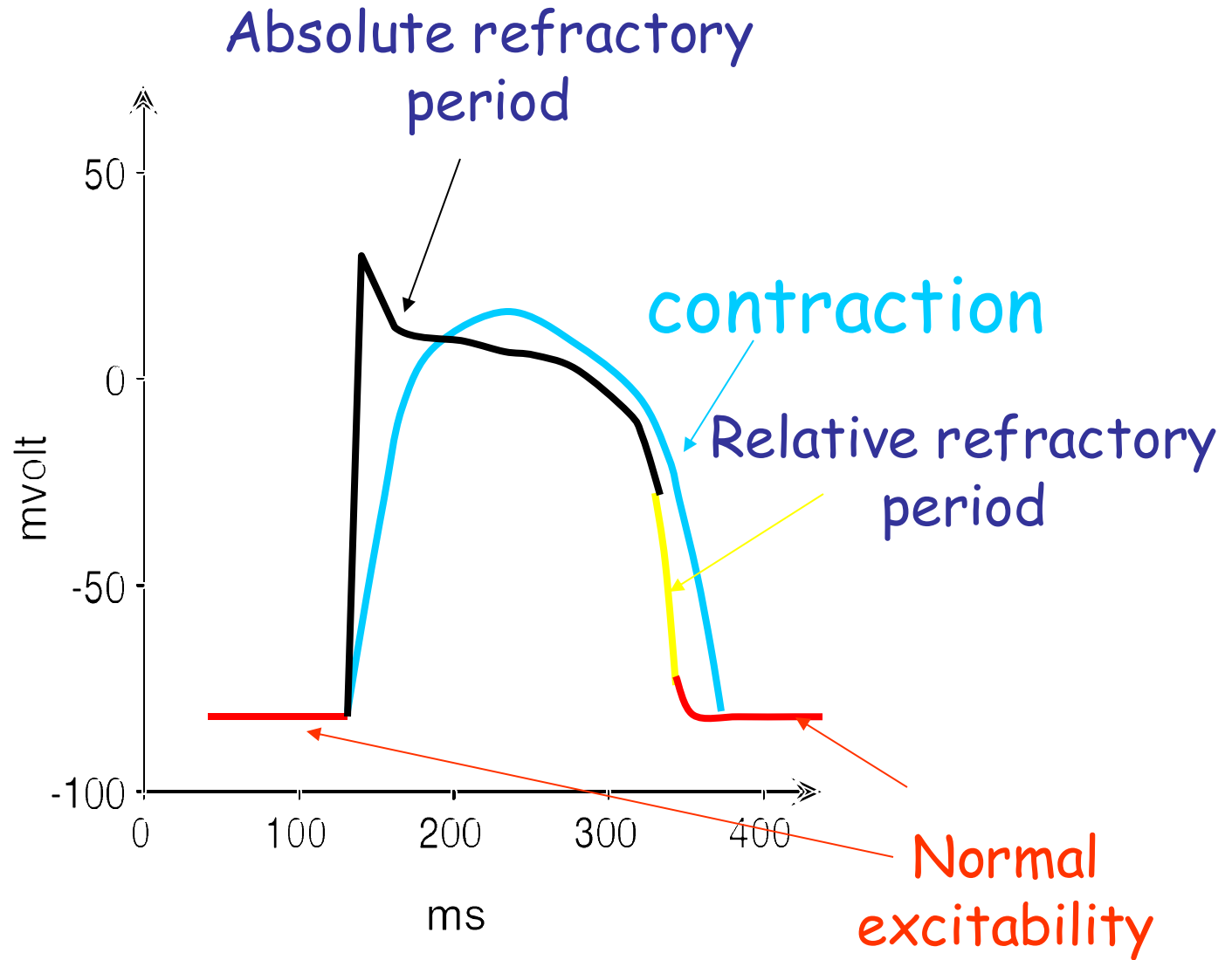

ELECTROCARDIOGRAM:

physiological bases; arrangement of the electrodes in the derivations standard;

ECG waves.

What he says ewhat the ECG does not say

onde elettrocardiografiche

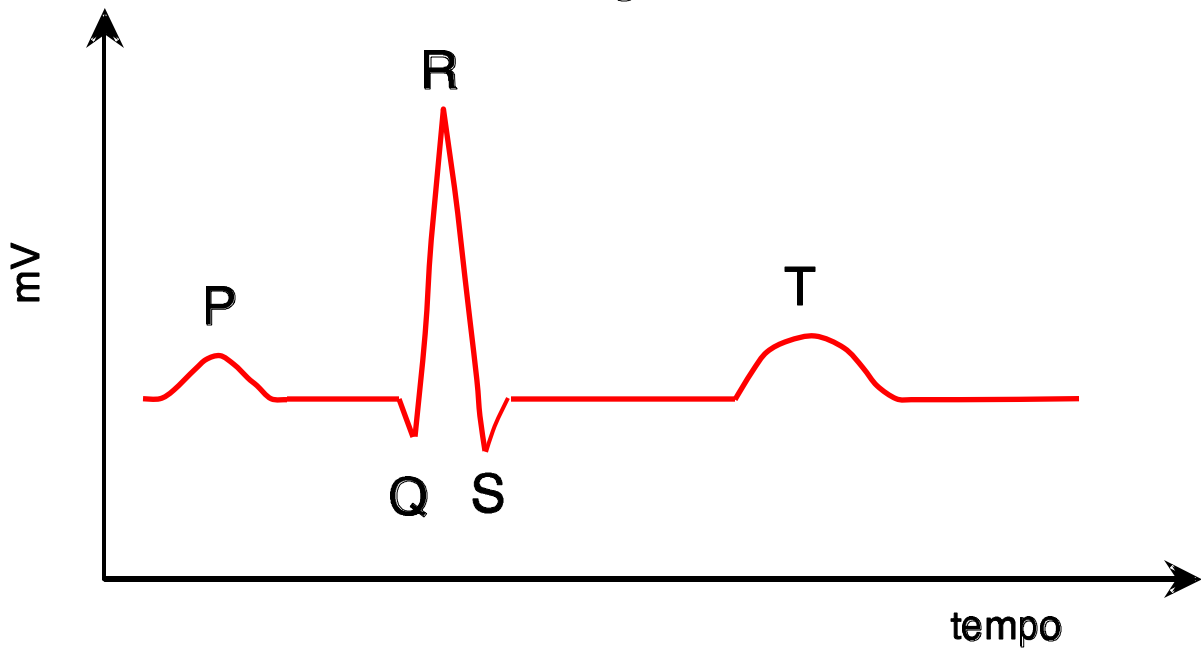

intervalli elettrocardiografici

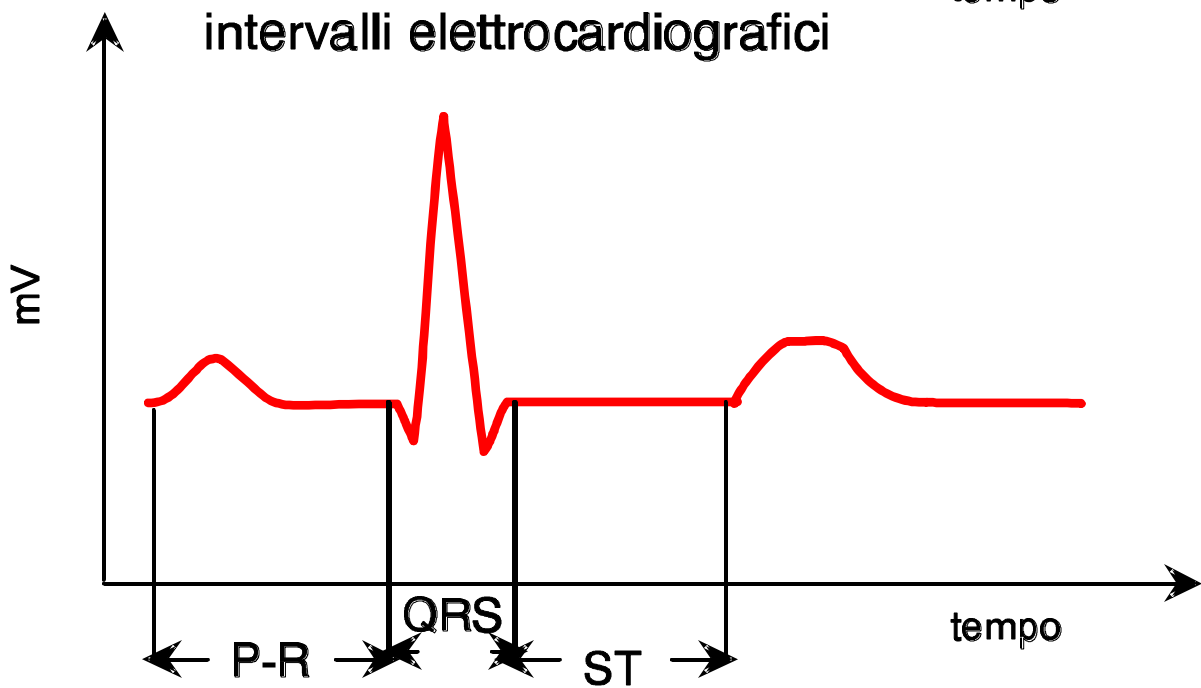

Long QT syndrome (LQTS)

The congenital (idiopathic) form of long QT (LQTS) is mostly caused by gene mutations which encode proteins for cardiac ionic channel subunits

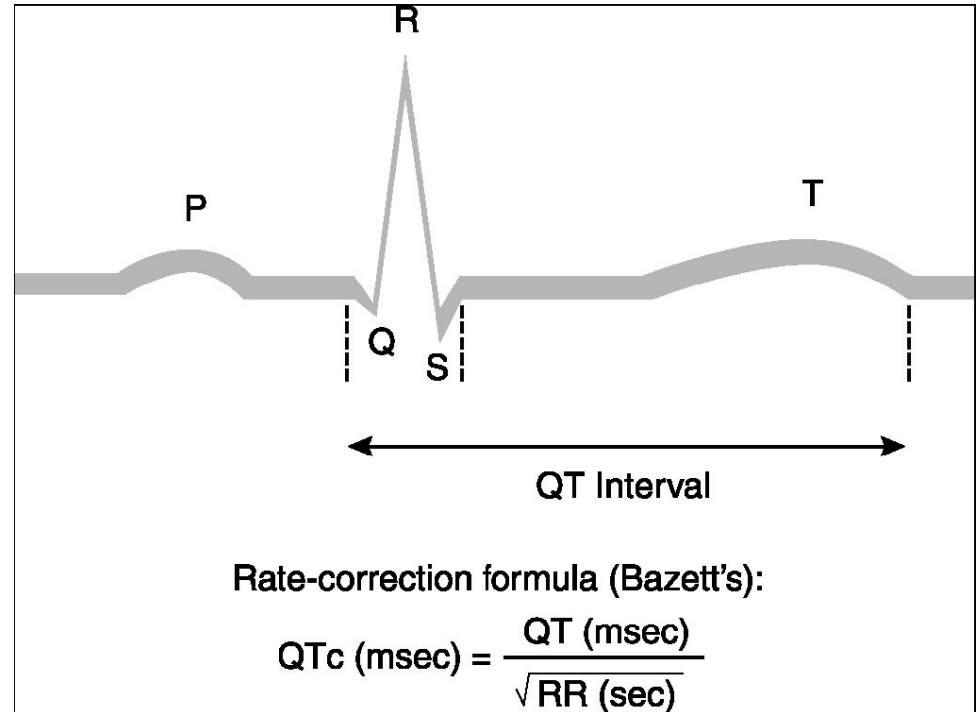

Among the various genotypes responsible for LQTS, the most common characteristic predisposing to arrhythmias is the lengthening of the ventricular action potential during cardiac repolarization, measured as the QT interval in the ECG.

LQTS-facts

- Normal QT interval: 360-440 ms
- Delayed repolarization of the myocardium, QT prolongation (>450 in man; > 470 in women).
- Increased risk for syncope, seizures, and SCD in the setting of a structurally normal heart
- 1/2500 persons.
- Usually asymptomatic, certain triggers leads to potentially life-threatening arrhythmias, such as Torsades de Pointes (TdP)

QT interval ranges

	Age 1 to 15	Adult man	Adult woman
Normal	Less than 0.44 second	Less than 0.43 second	Less than 0.45 second
Borderline	0.44 to 0.46 second	0.43 to 0.45 second	0.45 to 0.47 second
Prolonged	Greater than 0.46 second	Greater than 0.45 second	Greater than 0.47 second

Source: Jacobson C. Long and short of it: What's up with the QT interval? <http://hosted.mediasite.com/mediasite/Viewer/?peid=9ed8856fcdab4bc0bb066c25a148435b1d>.

Mutations

Type	Locus	Gene	Protein	Function	Frequency
LQT1	11p15.5	KCNQ1	KV7.1 α	I_{Ks} ↓	30%-35%
LQT2	7q35	KCNH2	KV11.1 α	I_{Kr} ↓	25%-30%
LQT3	3p21	SCN5A	NaV1.5 α	I_{Na} ↑	5%-10%
LQT4	4q25	ANK2	Ankyrin-B	$I_{Na,K}$ ↓ I_{NCX} ↓	1%-2%
LQT5	21q22.1	KCNE1	minK β	I_{Ks} ↓	1%
LQT6	21q22.1	KCNE2	MiRP1 β	I_{Kr} ↓	Rare
LQT7*	17q23	KCNJ2	Kir2.1 α	I_{K1} ↓	Rare
LQT8†	12p13.3	CACNA1C	CaV 1.2 $\alpha1c$	$I_{Ca,L}$ ↑	Rare
LQT9	3p25	CAV3	Caveolin-3	I_{Na} ↑	Rare
LQT10	11q23	SCN4B	NaV1.5 $\beta4$	I_{Na} ↑	Rare
LQT11	7q21	AKAP9	Yotiao	I_{Ks} ↓	Rare
LQT12	20q11.2	SNTA1	A1-syntrophin	I_{Na} ↑	Rare

Table 1
Genes and electrophysiology^a

LQT subtype	Gene name	Locus	Configurations with 2 variant gene copies ^b	Encoded protein	Ion current affected	Effect of mutation	Common triggers [5]	Spectrum of ECG findings [6]
LQT1	KvLQT1, KCNQ1	11p15.5	Homozygous mutations cause Jervell and Lange-Nielsen syndrome (JLNS)[4] ^c ; compound heterozygous mutations described	Alpha subunits forming a tetramer	I _{Ks}	Loss-of-function; rare gain-of-function with short QT syndrome has been observed ^d	Exercise, esp. swimming; emotional stress	Normal appearing T-wave; broad based T-wave; late-onset normal-appearing T-wave
LQT2	HERG, KCNH2	7q35-36	Homozygous and compound heterozygous mutations described; homozygous may present with congenital AV block	Alpha subunits forming a tetramer	I _{Kr}	Loss-of-function; rare gain-of-function with short QT syndrome has been observed	Rest/sleep, auditory stimuli, emotional stress; postpartum state	Subtle, obvious, or widely split notched/bifid T-wave; low-amplitude T-wave
LQT3	SCN5A	3p21-24	Homozygous and compound heterozygous mutations described	Four-domain alpha subunit	I _{Na}	Gain-of-function; loss-of-function mutations lead to varied presentations (Brugada syndrome, conduction system disease)	Rest/sleep	Late-onset peaked, biphasic T-wave; asymmetrical peaked T-wave
LQT4	ANKB, ANK2	4q25-27		Membrane anchoring protein	Affects Na ⁺ , K ⁺ , Ca ²⁺ exchange	Loss-of-function	Exercise, emotional stress (based on limited data)	Sinus bradycardia; inverted, bifid, or low-amplitude T-wave; inconsistent QT prolongation; prominent U-wave; frequent PVCs
LQT5	minK, IsK, KCNE1	21q22.1-2	Homozygous mutations can cause JLNS [4]; (2) compound heterozygous mutations described	Beta subunit to KCNQ1	I _{Ks}	Loss-of-function	(Insufficient data)	(Insufficient data)
LQT6	MiRP1, KCNE2	21q22.1		Beta subunit to HERG	I _{Kr}	Loss-of-function	(Insufficient data)	(Insufficient data)
LQT7	Kir2.1, KCNJ2	17q23		Kir2.1 subunits forming a tetramer	I _{K1}	Loss-of-function; rare gain-of-function with short QT syndrome has been observed	Accompanied by alterations in serum K ⁺ level in some cases	Prominent U-wave; prolonged terminal T downslope; modest QT prolongation; frequent PVCs; bigeminy; bidirectional ventricular tachycardia
LQT8	CACNA1C	12p13.3		Alpha subunits forming a tetramer	I _{Ca,L}	Gain-of-function	Hypoglycemia, sepsis (2 cases)	Severe QT prolongation (up to 650 ms); 2:1 atrioventricular block; overt T-wave alternans

^aTable completed 6/29/05.

^bThe normative LQTS gene configuration is heterozygous with one variant gene copy.

^cNumbers with brackets refer to citations in Reference section.

^dSee Disease Associations section.

Genetics

- **7 Genes on chromosomes 3, 4, 7, 11 and 21 identified**
- **Most frequent are mutations on KCNQ1-gene (LQT1 30%) and on KCNH2-gene (LQT2 30%).**

LQT1-Syndrom: KCNQ1, mutations slow K-channel

LQT2-Syndrom: KCNQ2 mutations fast K-channel

LQT3-Syndrom: SCN5A, mutations Na-channel

LQT4-Syndrom: ankyrin B, mutations unknown

LQT5-Syndrom: KCNQ1, mutations slow K-channel

LQT6-Syndrom: KCNQ2, mutations fast K-channel

CARDIAC ACTION POTENTIAL

- **Phase 0. Influx of Na^+ (I_{Na}). Induces membrane depolarization**
- **Phase 1. Efflux of K^+ (I_{to}). Limits the Na^+ spike**
- **Phase 2. Influx of Ca^{2+} (I_{Ca}). Activation of I_{K} . Balance between Ca^{2+} influx and K^+ efflux. Ca^{2+} enters the cell to trigger the Ca^{2+} -induced Ca^{2+} release.**
- **Phase 3. Efflux of K^+ (I_{K}) increases. Repolarization starts**
- **Phase 4. Restoration of the resting potential: equilibrium potential of K via I_{K1} and Na^+ / K^+ pump, $\text{Na}^+ / \text{Ca}^{2+}$ pump.**

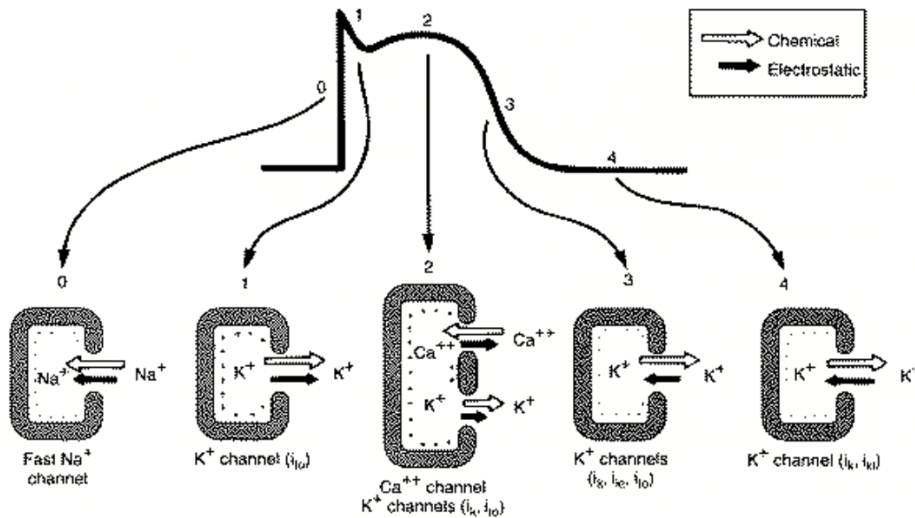

B Ventricular myocyte action potential

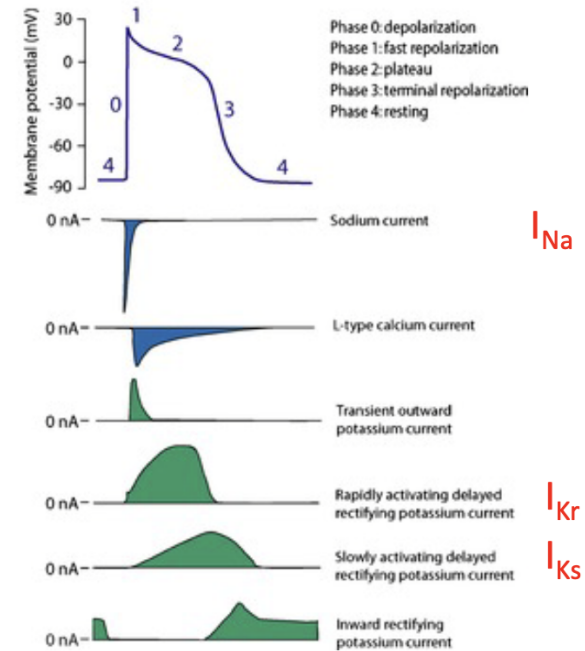

Pathophysiology of LQT (1, 2, 3)

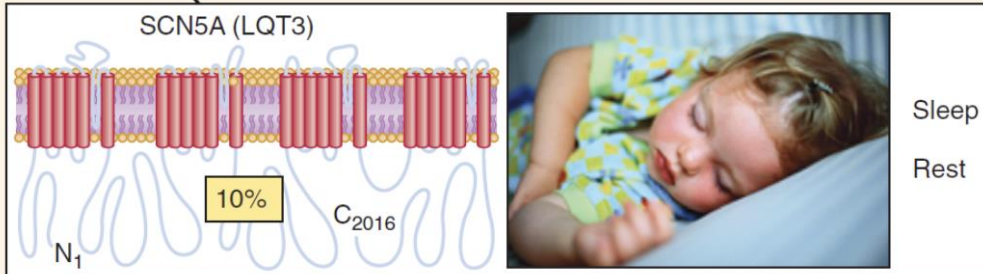
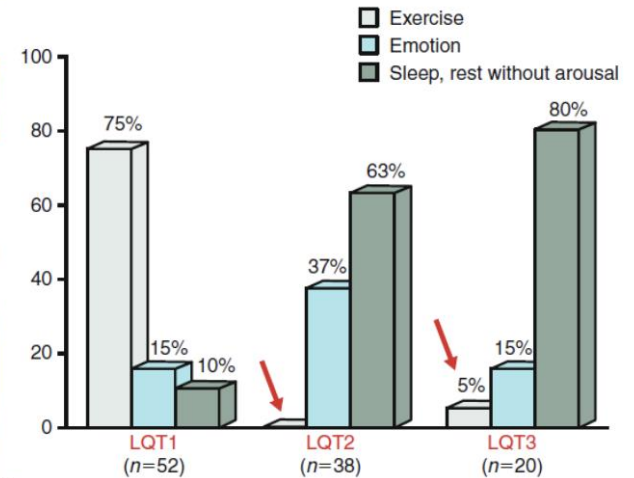
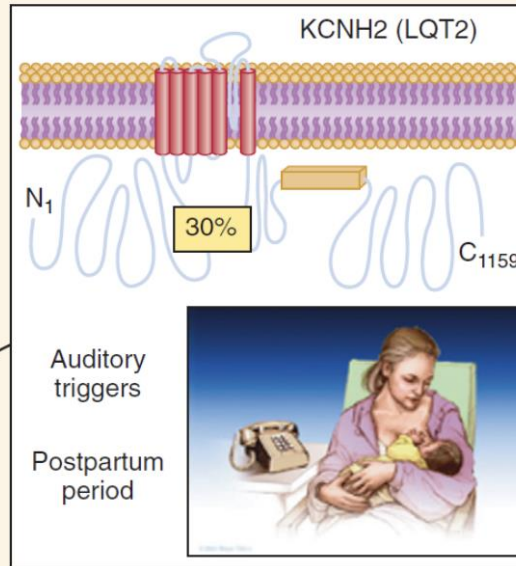
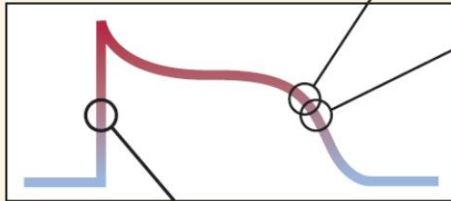
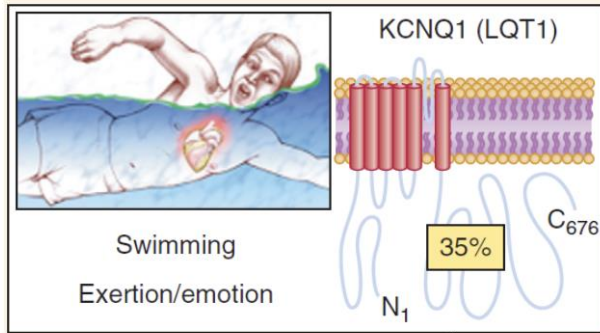

TdP triggers in congenital LQTS

- **LQTS1:** Emotional stress or exercise, especially swimming or diving
- **LQTS2:** Extreme emotions or surprises, such as harsh, sudden noises
- **LQTS3:** Slow heart rate while sleeping

Source: National Heart, Lung, and Blood Institute. What is long QT syndrome? http://www.nhlbi.nih.gov/health/dci/Diseases/qt/qt_all.html.

LQT syndromes: proarrhythmic mechanisms

- Upregulation of inward currents

Or

- Downregulation of outward currents

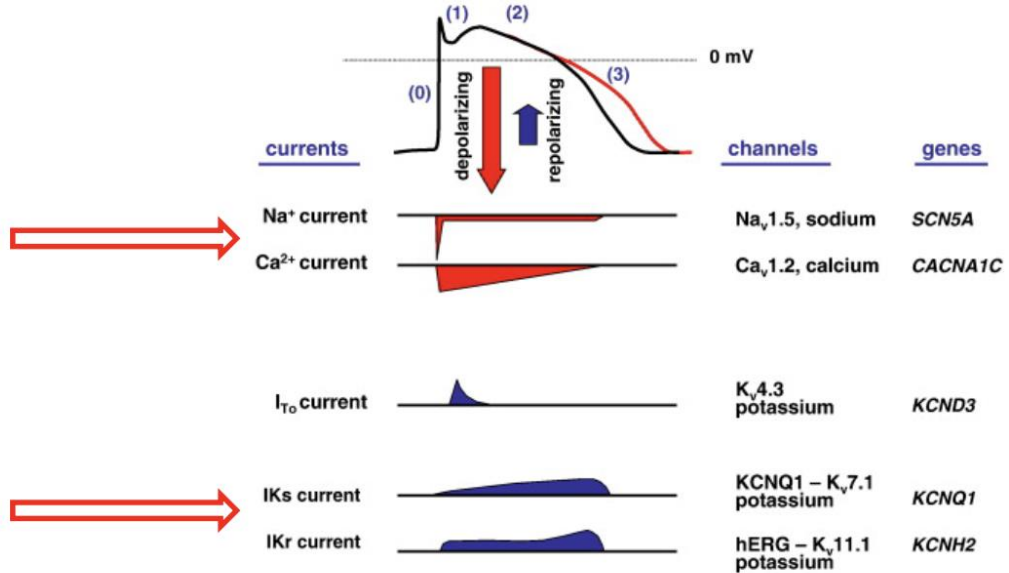

- EADs → triggers

- Dispersion of APDs
→ substrates
→ reentry

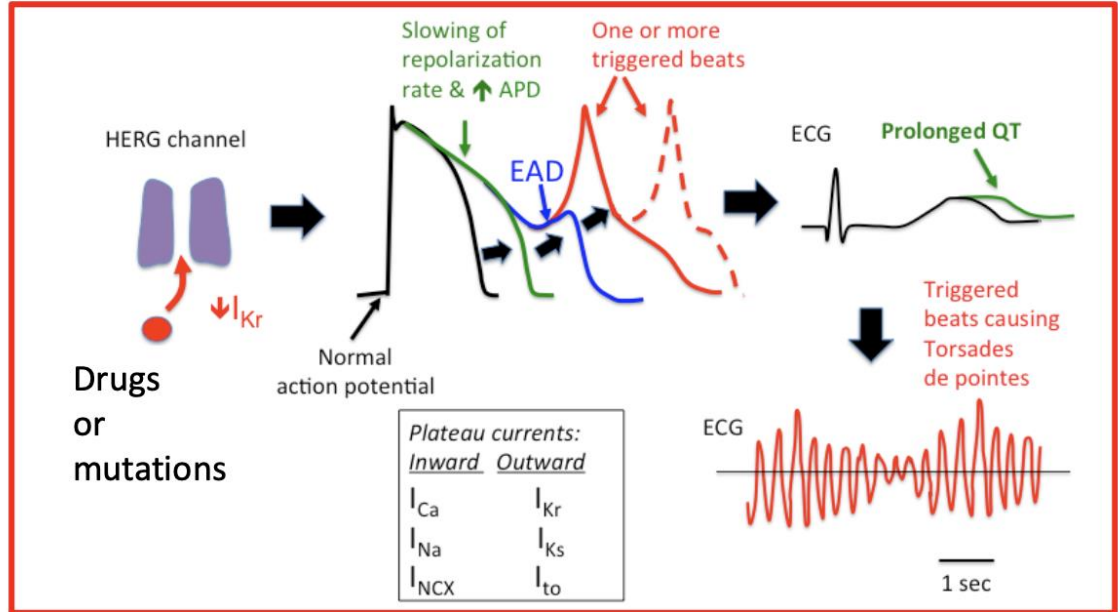

LQTS

1:7000 bis 1:10000 all newborn

Congenital (60 %)

Sporadic (40 %)

Romano Ward (99%)

Autosomal dominant

LQT1 (25%), LQT2 (25%), LQT3 (10%)

Mild-severe

LQT5 (1%), LQT6 (1%)

Mild

Autosomal rezessiv

LQT1-3 (1%)

severe

Jervell-Lange-Nielsen-syndrom (<1%)

Autosomal rezessiv

LQT1 (75%), LQT5 (25%)

Anderson-syndrom

Autosomal dominant with extracardiac involvement

LQT7

New mutations (LQT1-3)

Ventricular action potential

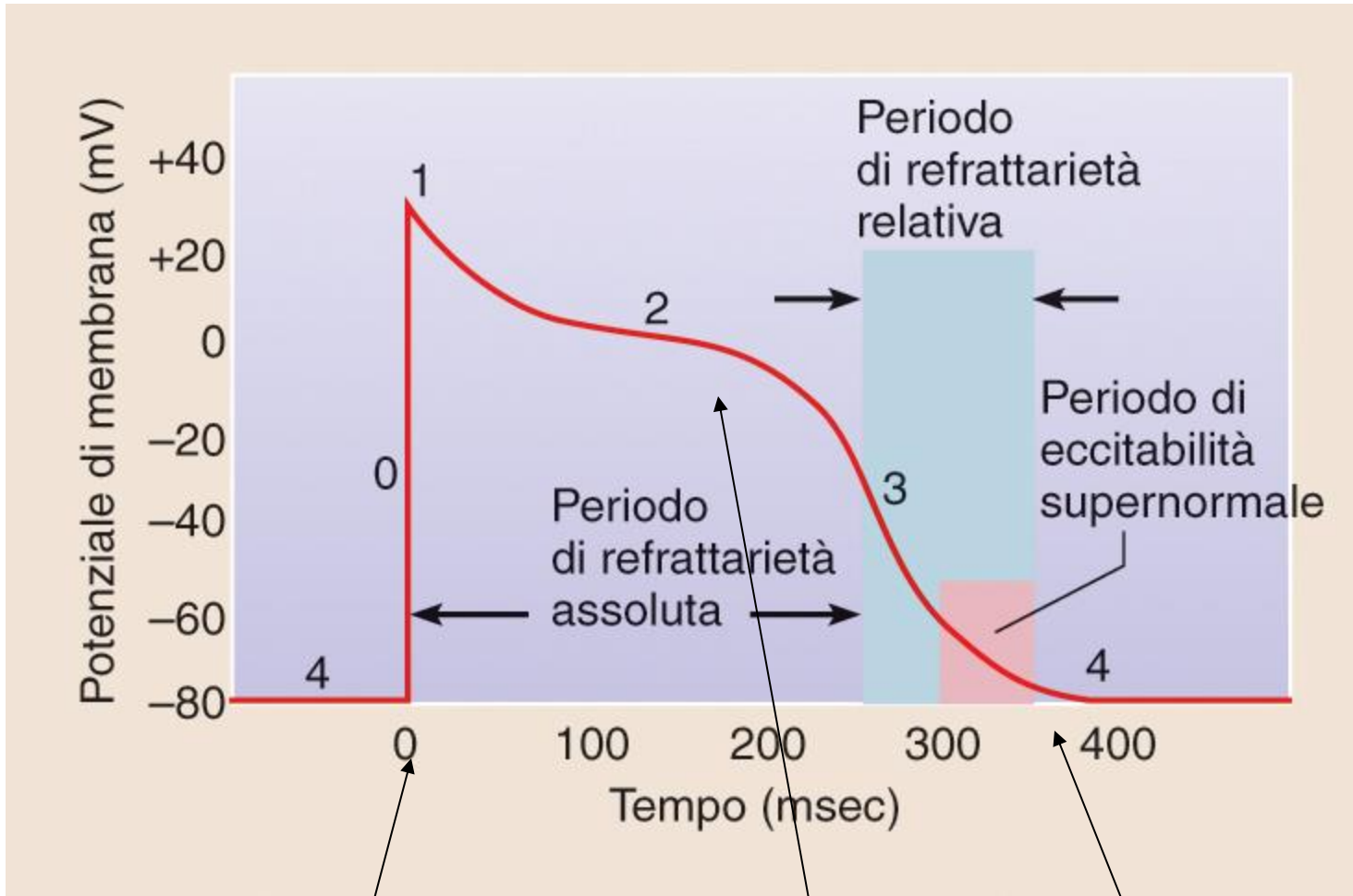

Na⁺

Ca²⁺ e K⁺

K⁺

ECG

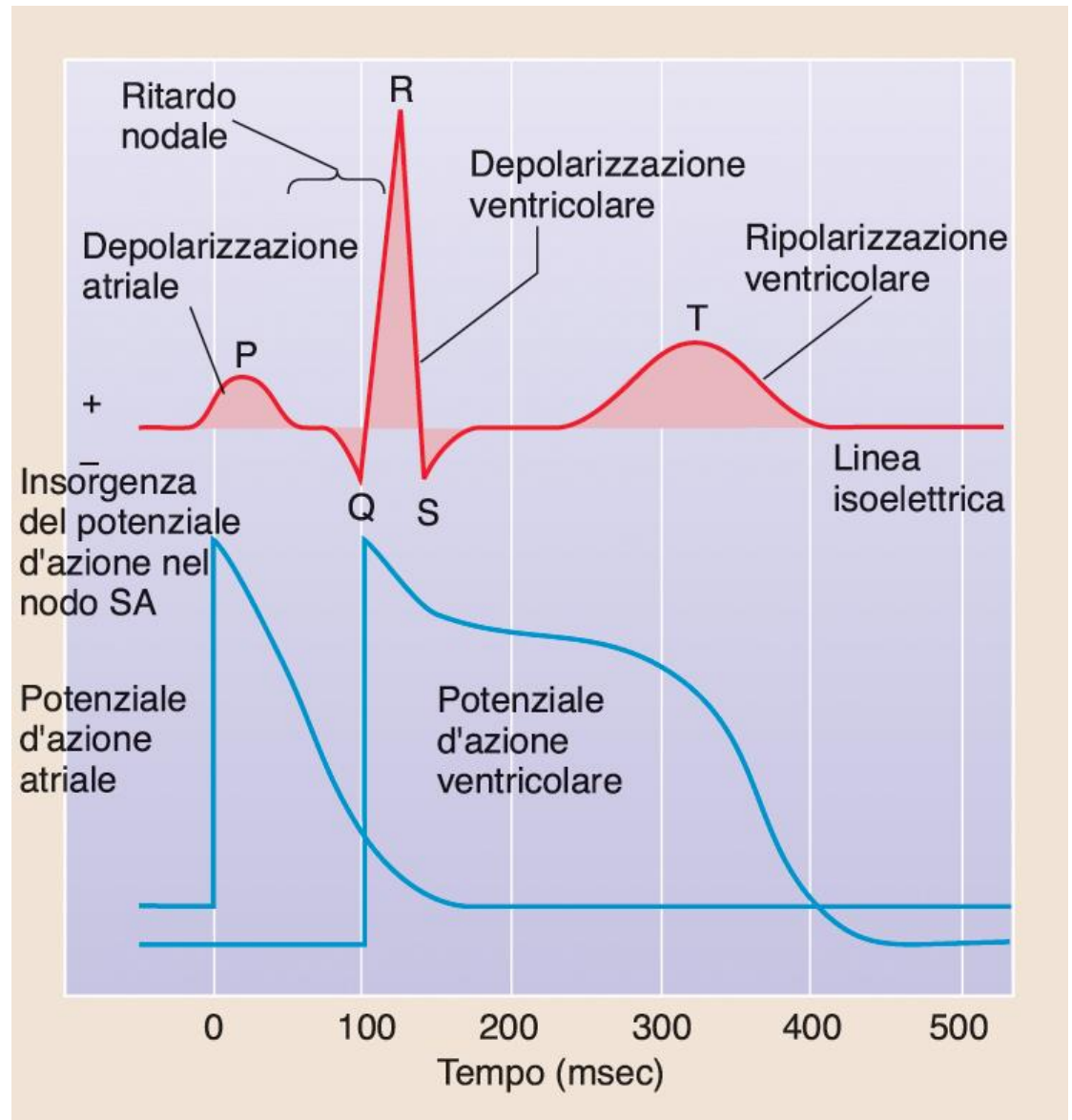

Ventricular action potentials, genes responsible for LONG-QT and ionic currents

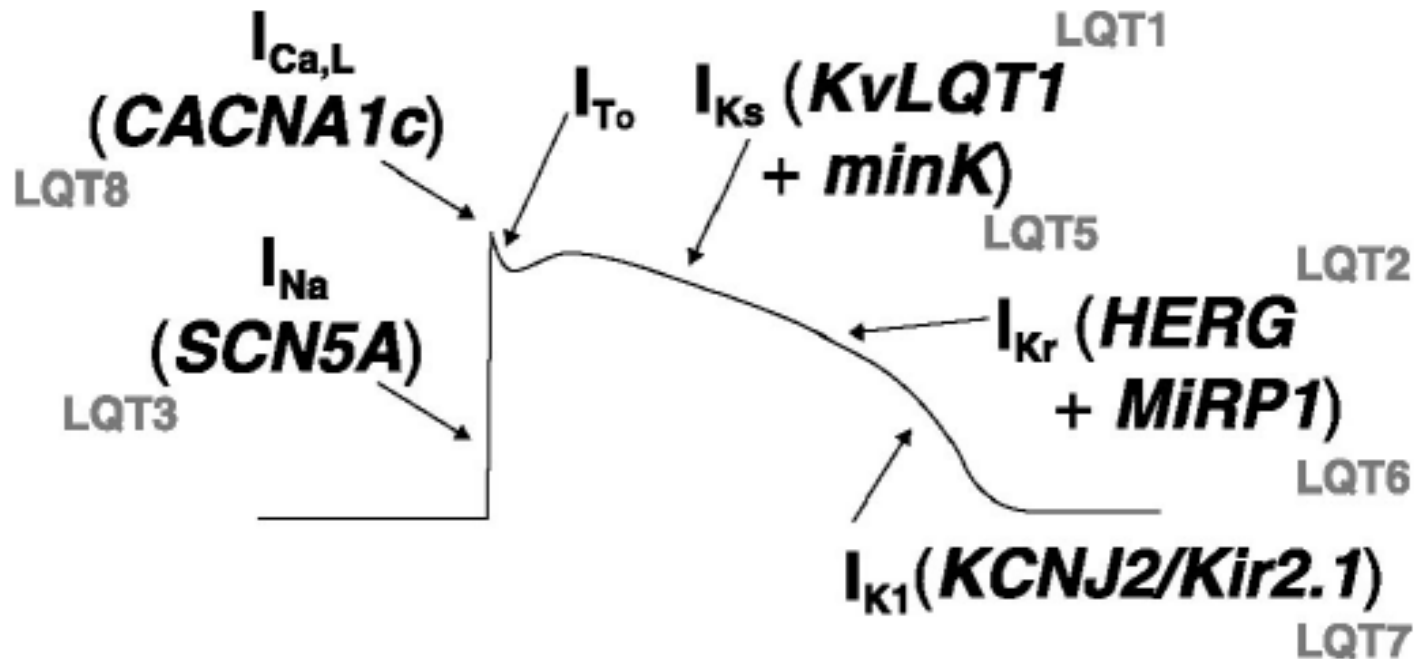

Fase 0: rapido influsso di Sodio (I_{Na}).

Fase 1 (picco): ripolarizzazione rapida transiente outward di potassio (I_{To}).

Fase 2 (plateau) : bilancio tra influsso di Na e Ca (L-type) ($I_{Ca,L}$), ed efflusso di K (I_{Ks} , I_{Kr}) e Cl.

Fase 3: ripolarizzazione ottenuta mediante l'aumento della conduttanza rapida del K (I_{Kr}) con il contributo delle conduttanze lente del K (I_{Ks}) e delle rettificanti (I_{K1}).

Fase 4: La cellula torna al suo potenziale di riposo

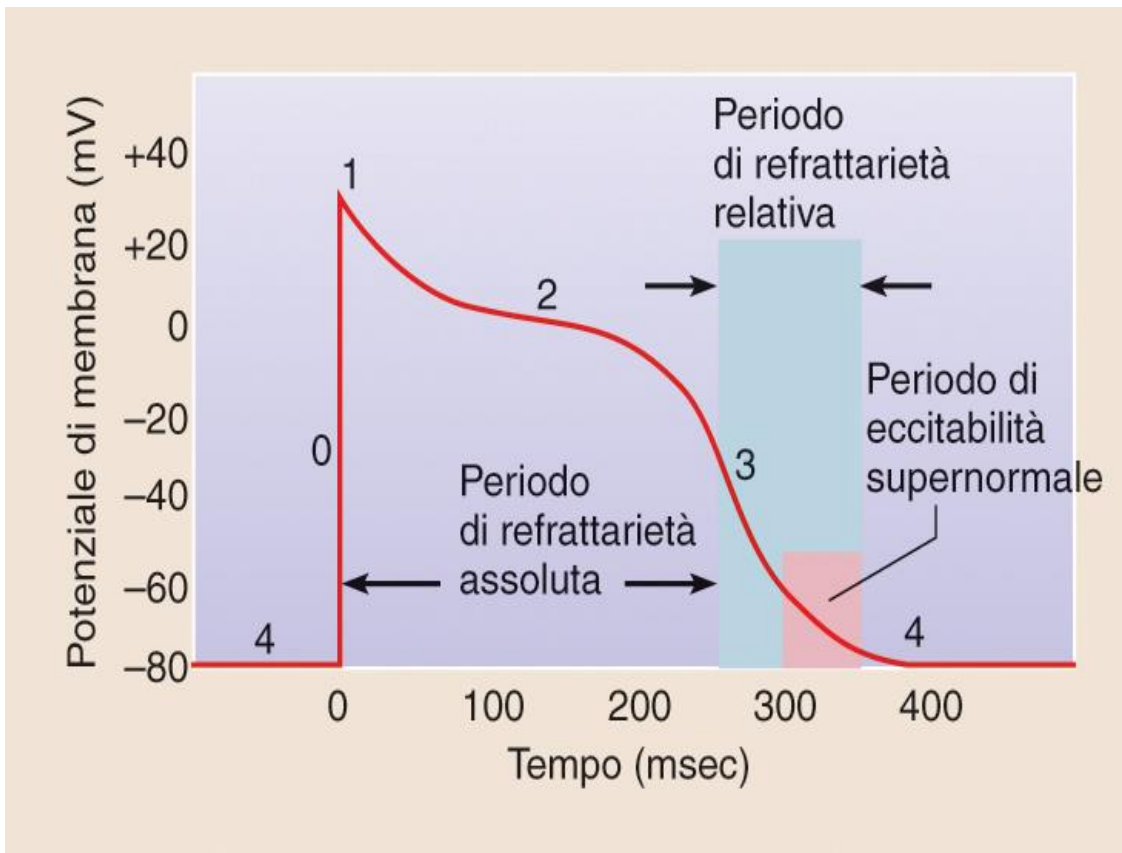

From a functional point of view, the prolongation of the QT interval corresponds, at the cellular level, a prolongation of the duration of the cardiac action potential.

The defects in the potassium channels are associated with a loss of function, which is followed by a "slowing down" of the repolarization phase of the cardiac myocytes and therefore a prolongation of the duration of the action potential.

ECG

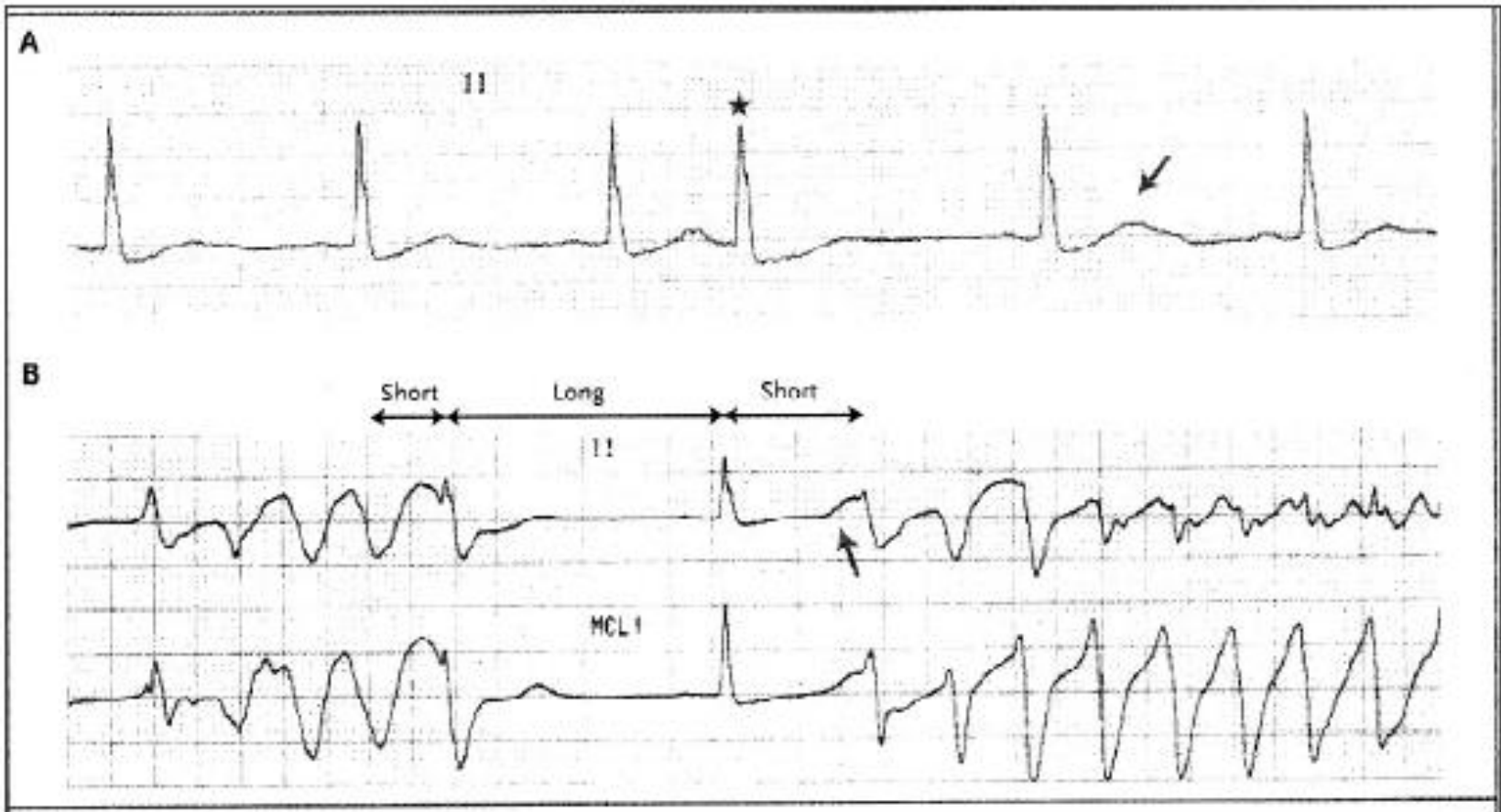

ECG - LQT

- *QT-prolongation, QT-dispersion*
- *T wave changes, U - wave*
- *Bradycardia*
- *polymorphic VT/TDP*

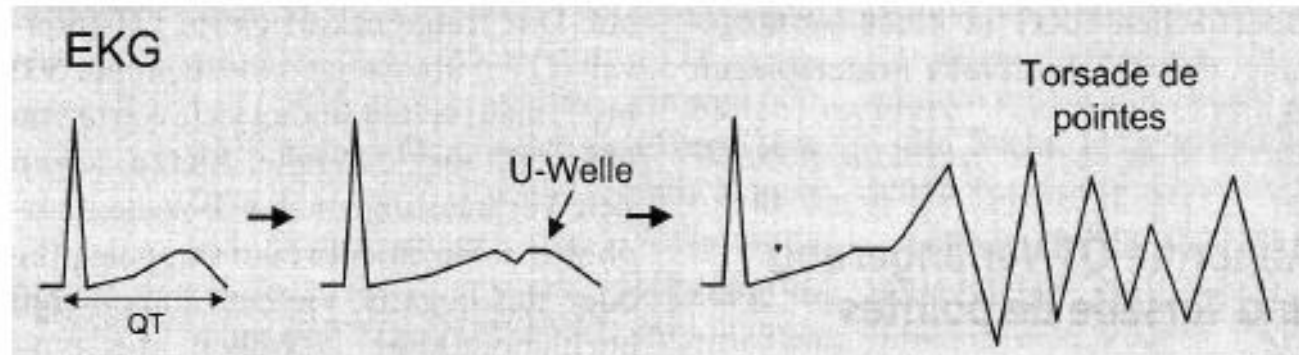

- *QT interval > 500 ms is commonly regarded as conferring an increased risk*

Electrical consequences

Slowing of repolarization (phase 3)

The onset of an early action potential is possible (activation of L channels for Ca^{2+}) during the period of relative refractiveness.

The longer the phase 3 is extended, the higher the risk of "Early post-depolarization"

It can start in a series of electrical complexes of variable conformation (torsades de pointes, TdP), which can spontaneously stop or turn into ventricular fibrillation.

In the first case there will be a syncope, in the second the risk of sudden death is very high.

Not all gene modifications that can cause sudden death induce TDP.

This form of tachyarrhythmia is frequent when gene modification involves a current at K^+ in phase 3 (LQT1, LQT2, LQT5, LQT6). LQT3, related to modifications of the gene that codes for the voltage-dependent Na^+ channel (SCN5A), manifests itself mainly as ventricular fibrillation

Are mutations all equivalent?



The site of the mutation determines the severity of the LQTS phenotype.

Patients with LQT2 mutation at the pore level appear to be at greater risk of cardiac events than mutations at sites outside the pore.

SINDROME	CROMOSOMA	NOME	PROTEINA	CORRENTE
<i>LQT1</i>	11	<i>KCNQ1</i> o <i>KVTLQT1</i>	subunità- α canale al K^+	corrente <i>IKs</i> .
<i>LQT2</i>	7	<i>HERG</i> (<i>human ether-a-go-go related gene</i>)	subunità- α del canale al K^+	corrente <i>IKr</i>
<i>LQT3</i>	3	<i>SCN5A</i>	subunità- α del canale al Na^+	corrente <i>INa</i> .
<i>LQT4</i>	4	<i>ANK2</i>	proteina citoscheletrica ankirina B	
<i>LQT5</i>	21	<i>KCNE1</i> o <i>MinK</i>	subunità- β del canale al K^+	corrente <i>IKs</i>
<i>LQT6</i>	21	<i>KCNE2</i> o <i>MiRP1</i>	subunità- β del canale al K^+	<i>IKr</i>
<i>LQT7</i>	17	<i>KCNJ2</i>	subunità- β del canale al K^+	subunità- β del canale al K^+

LQT1 and LQT2 have a higher frequency of cardiac events, but LQT3 has the highest incidence of lethal cardiac episodes.

Potassium channel mutations are not just responsible for LQTS

Organ				
Cell type	Cardiac myocyte	Stria vascularis	Outer hair cells	Forebrain neurons
Channel subunit composition	KCNQ1 + KCNE1	KCNQ1 + KCNE1	KCNQ4 (+ KCNQ3)	KCNQ2 + KCNQ3
Current	I _{sk}	I _{sk}	I _M -like	I _M -like
Phenotype	Long QT syndrome	Congenital deafness	Childhood onset deafness	Epilepsy

Example 1:

LQT1 and LQT2

Downregulation of delayed K⁺ channel, I_{Ks} and I_{Kr}

LQT1: KCNQ1 (KvLQT1) mutations

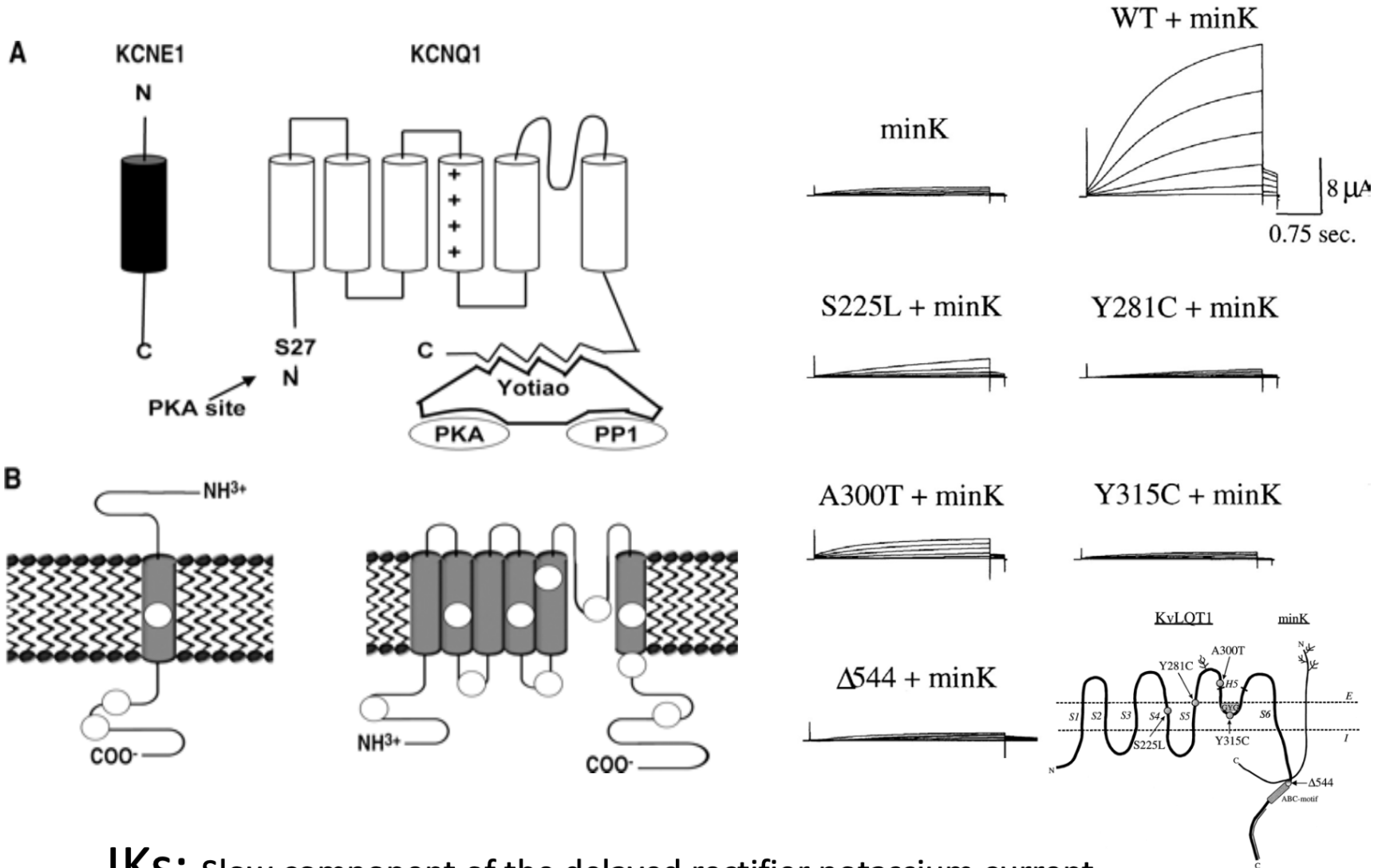

IKs: Slow component of the delayed rectifier potassium current

LQT2: KCNH2(HERG) MUTATIONS

KCNH2 (HERG)

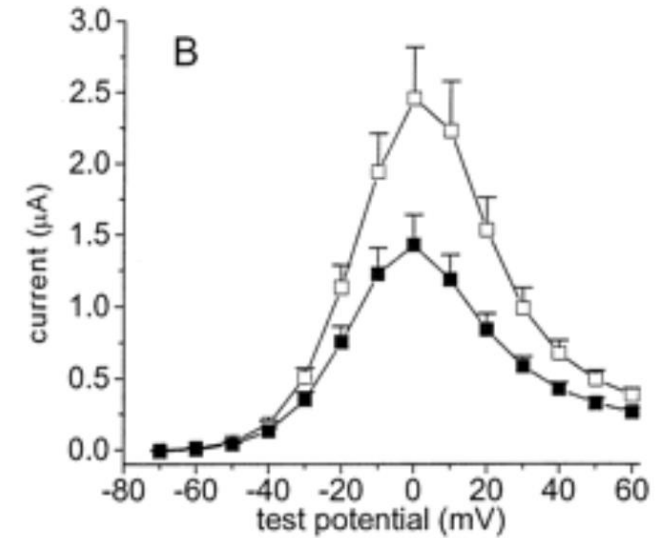
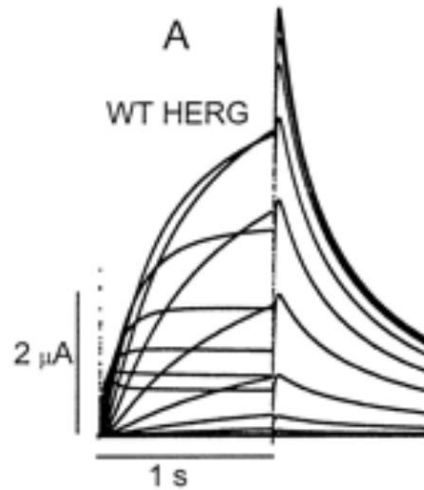
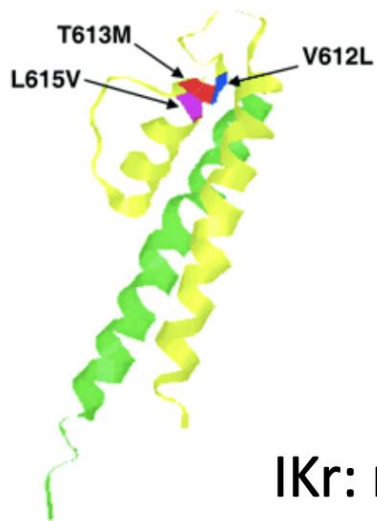
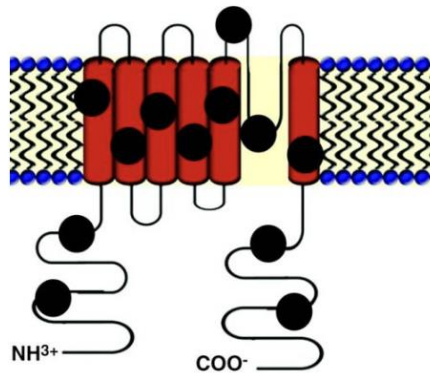

IKr: Rapid component of the delayed rectifier potassium current

LQT 1 and 2: I_{Ks} and I_{Kr} downregulation

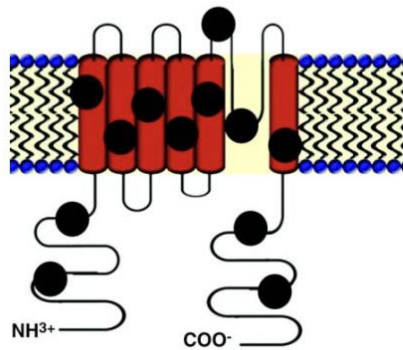

KCNQ1 or KCNE2 gene mutations
(I_{Ks}) (I_{Kr})

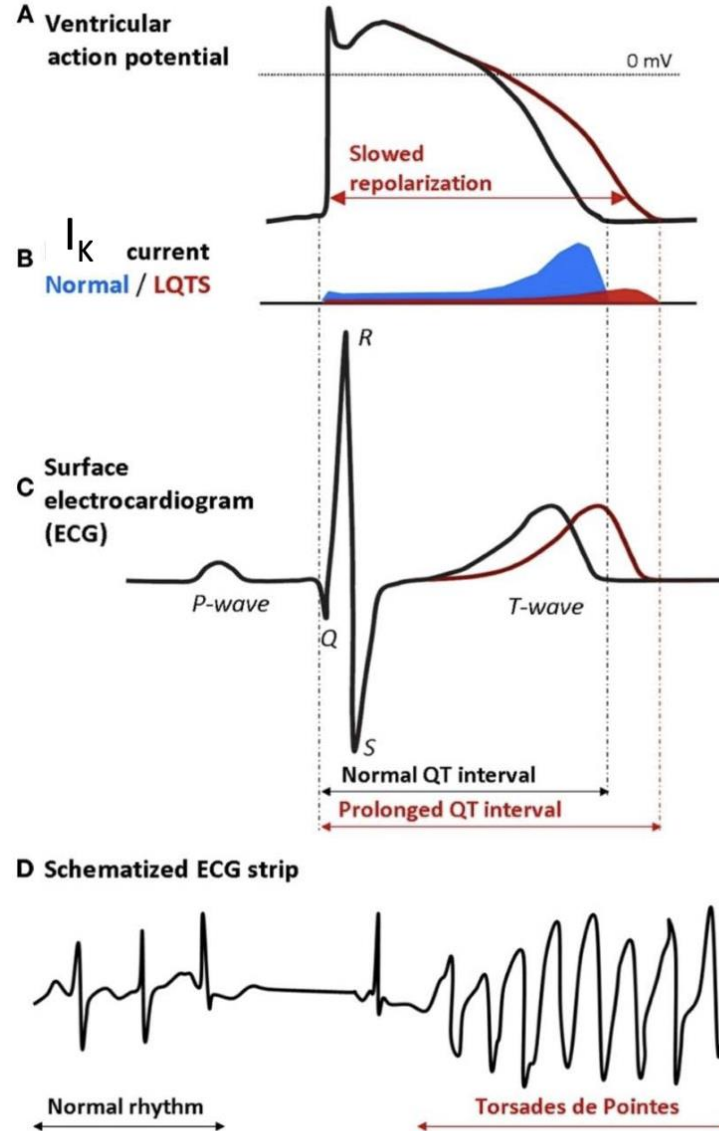

Example 2:

LQT3

Inactivation of Na^+ channel

LQT III

- Sodium channel mutated
- Incomplete inactivation of the channel

Symptoms

- Syncope
- Seizures
- Cardiac arrest
- Unexpected death

Diagnosis

- Analysis of the T wave of the ECG.



Normal ECG

- Genetic analysis on the SCN5A gene

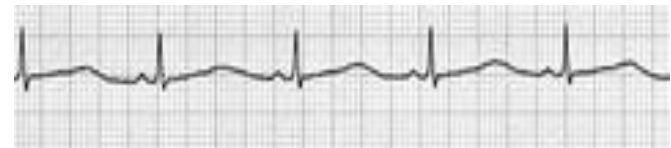

Long QT syndrome

Statistics

- 8% of patients with LQT are affected by the SCN5A mutation
- LQT-3 is one of the most deadly mutations
- Onset: 50% before 12 years; 90% before the age of 40
- Fatal arrhythmias - 39% at rest, 32% during physical exertion or emotional stress

LQT3: Increased persistent Na Current

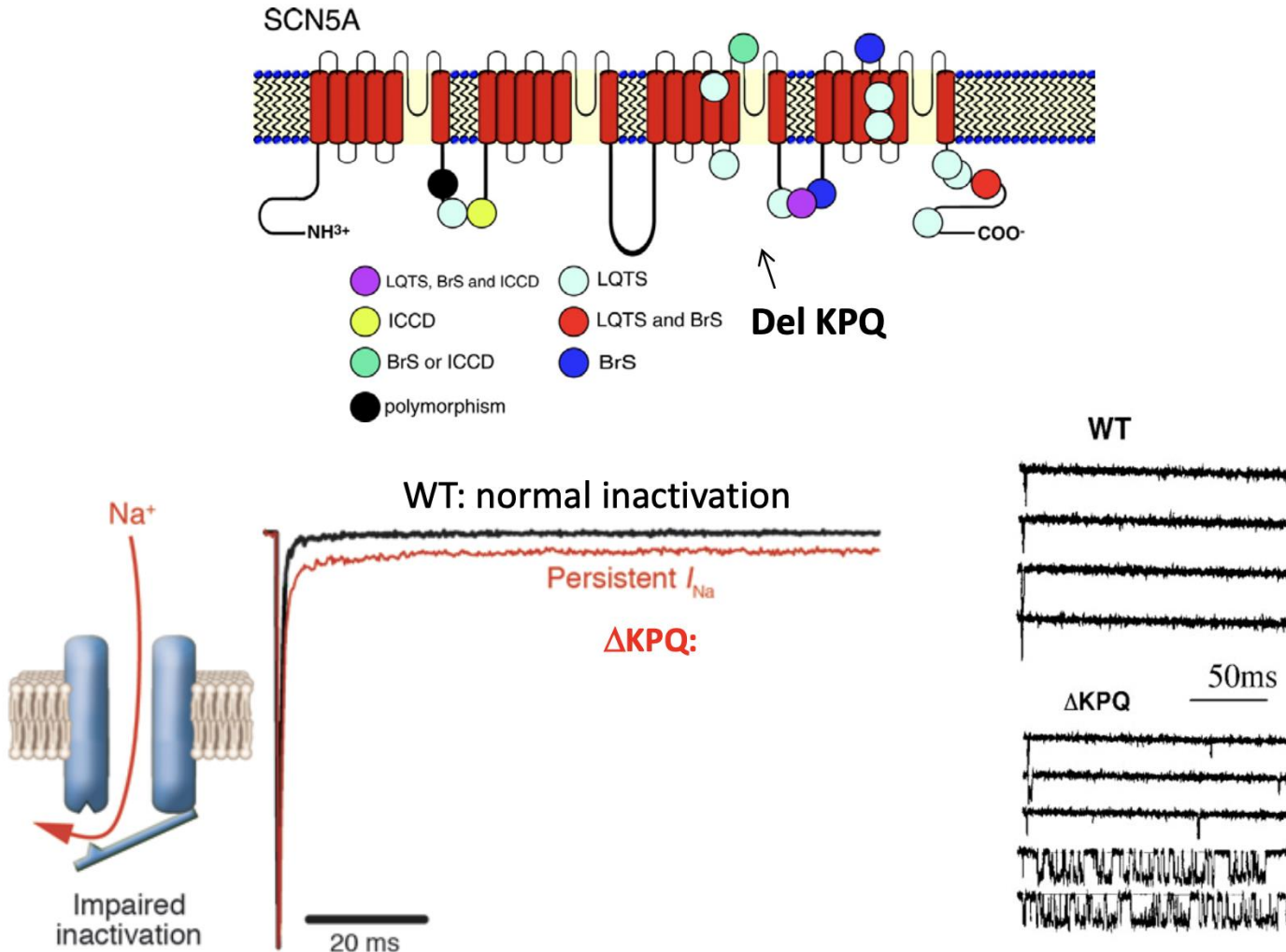

Mutation SCN5A

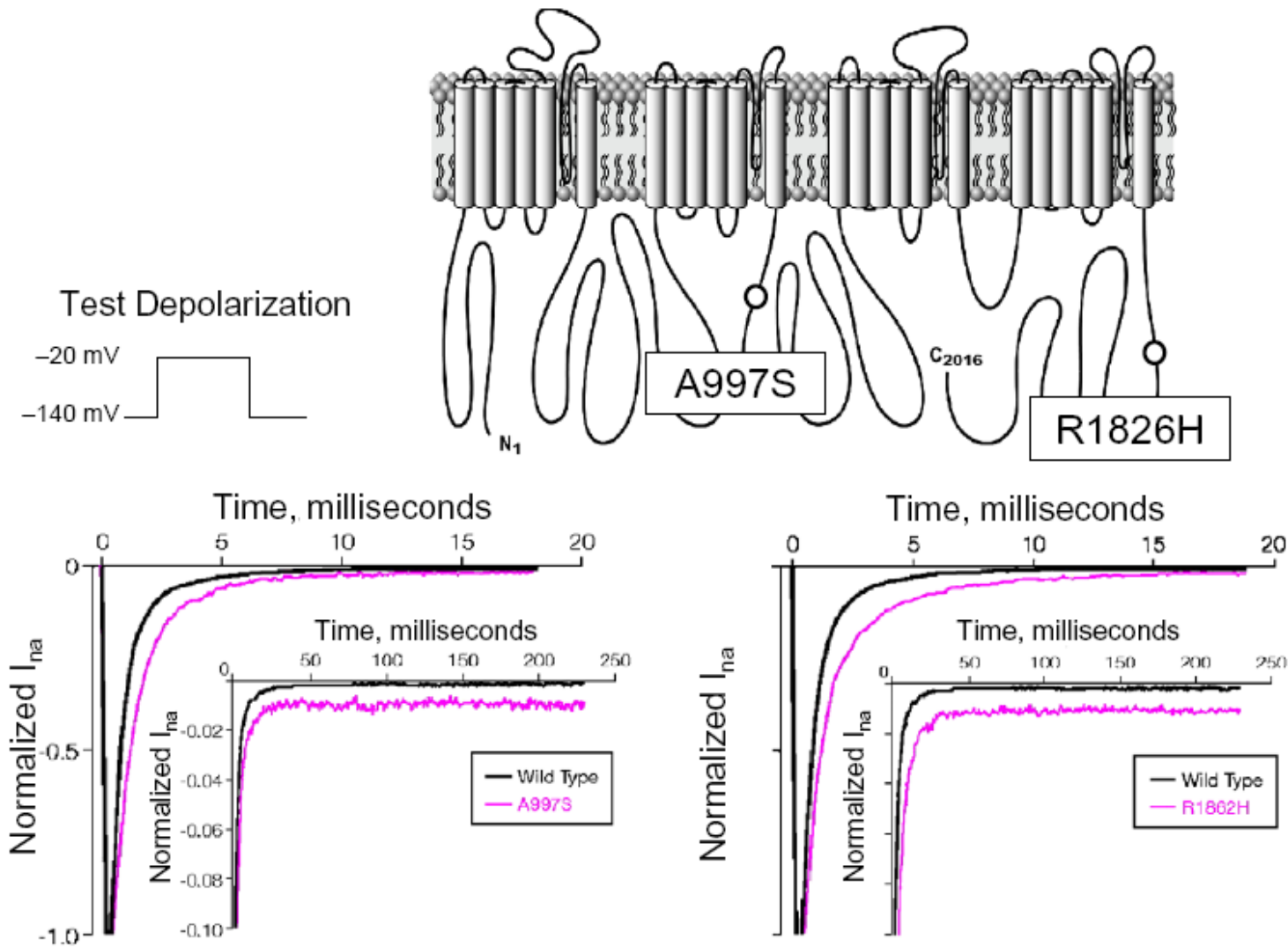

Function

- Selective channels to Na + voltage dependent
- Voltage sensors
- Responsible for the rapid ascent of the action potential

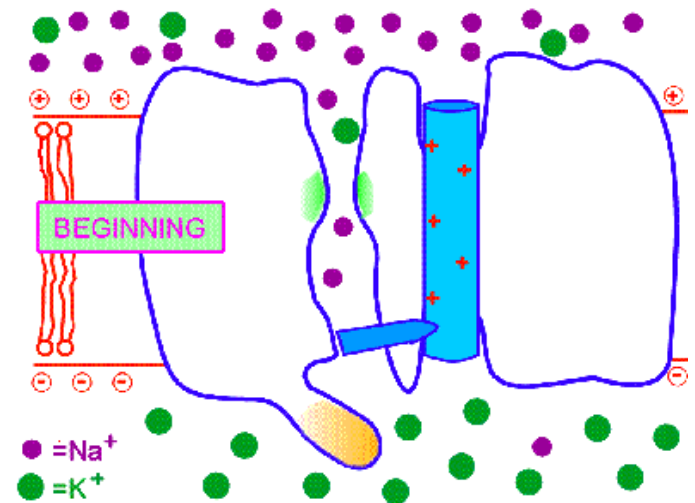

Functional mechanisms in LQT3

LQT3

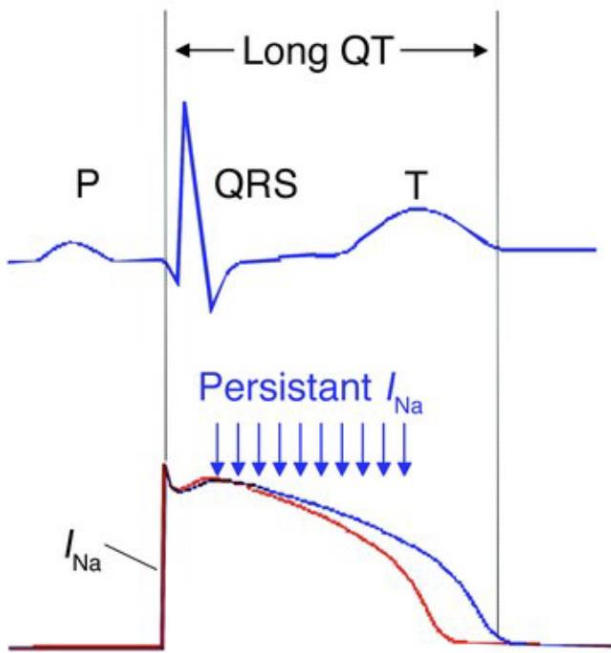

WT

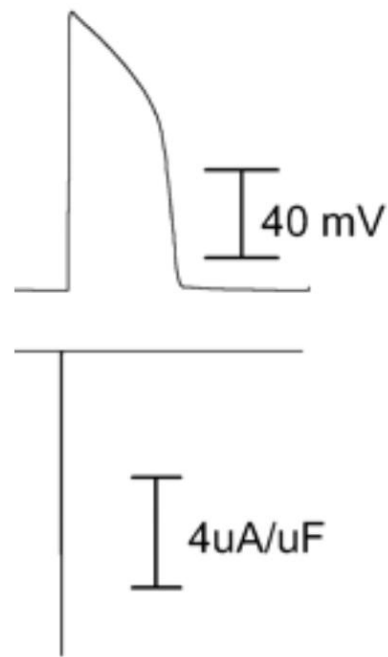

$\Delta K P Q$

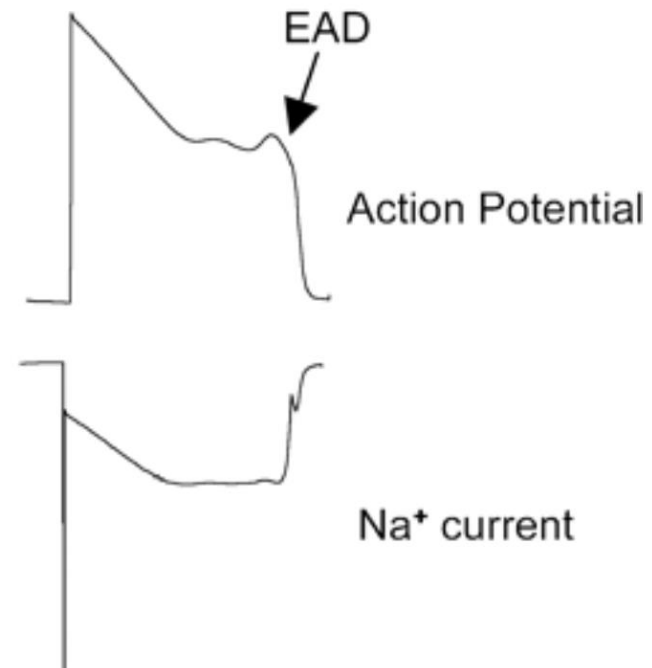

Introduction to LQT

Currently Recognized LQTS Disease Genes

Disease	Gene	Chromosome	Ion Channel
LQT1	KVLQT1	11p 15.5	I _{Ks} subunit
LQT2	HERG	7q35-6	I _{Kr}
LQT3	SCN5A	3q21-24	Na ⁺
LQT4	Unknown	4q25-27	Unknown
LQT5	Min K #	21	I _{Ks} Subunit

- Disorder caused by mutations in cardiac ion channels
- Most associated with K⁺ channels

Example 3:

Epilepsy - a CNS Channelopathies

Epileptic seizure

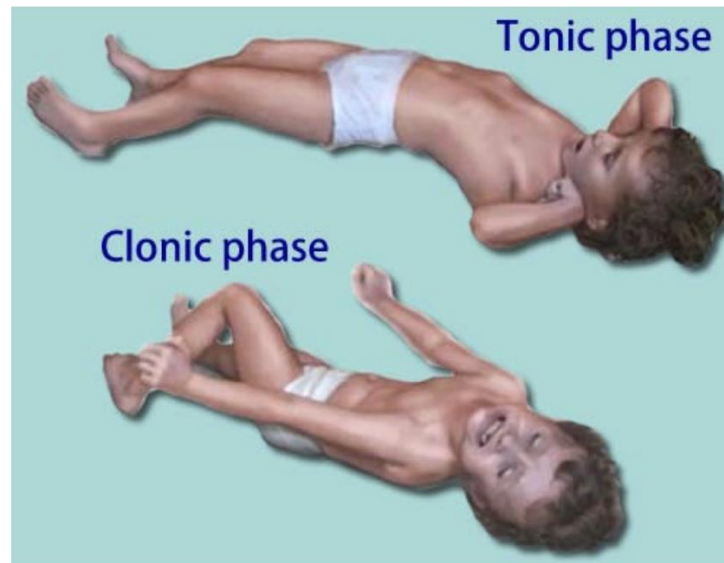

Epilepsy is a disorder marked by disturbed electrical rhythms in the central nervous system

**Idiopathic epilepsies: genetic
alterations of ion channels**

Epilepsy: Pathology and Symptom

Calcium Channelopathy and Absence Epilepsy

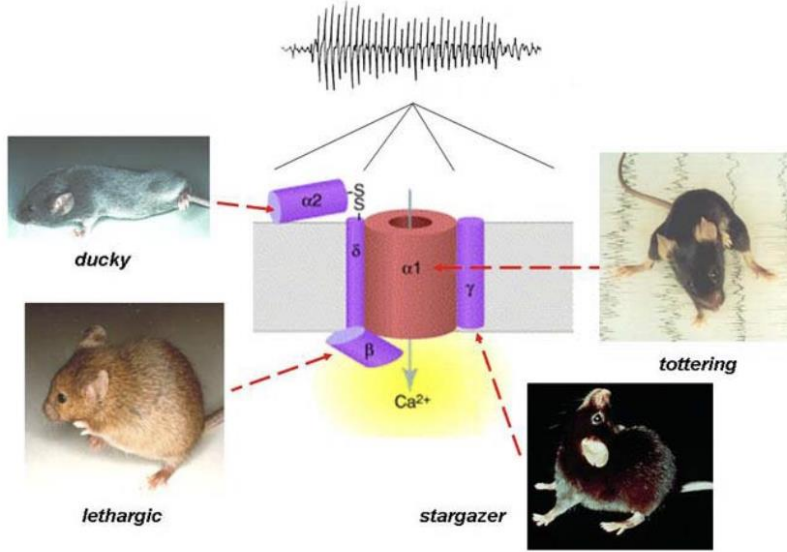

In mice

In human

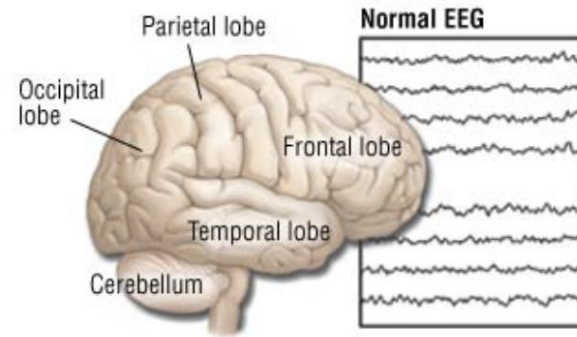

Partial seizure EEG

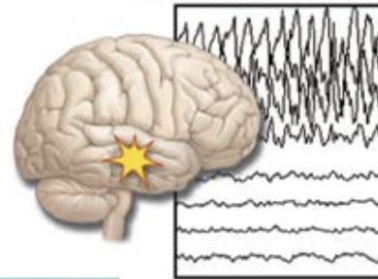

Generalized seizure EEG

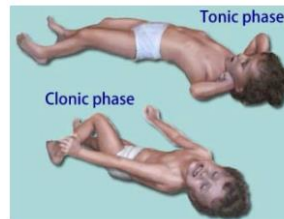
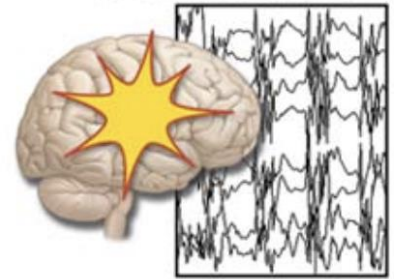

Electroencephalogram (EEG)

disturbed electrical rhythms

Idiopathic epilepsies

- I. Reactive syndromes
 - A. Neonatal seizures due to reversible causes
 - B. Benign febrile convulsions
 - C. “Low threshold” reactive seizures
- II. Idiopathic syndromes
 - A. Benign Neonatal convulsions
 - 1. Familial
 - 2. Non familial
 - B. Partial syndromes
 - 1. Benign childhood epilepsy with centrotemporal spikes
 - 2. Childhood epilepsy with occipital paroxysms
 - C. Generalized syndromes
 - 1. Childhood absence epilepsy (CAE)
 - 2. Juvenile absence epilepsy (JAE)
 - 3. Epilepsy with generalized tonic-clonic seizures on awa
 - 4. Juvenile absence epilepsy (JME)
- III. Symptomatic syndromes
 - A. Neonatal seizures due to irreversible causes
 - B. Partial syndromes
 - 1. Epilepsia partialis continua (Kojewnikow’s syndrome)
 - a. Encephalopathic form (Rasmussen’s syndrome)
 - b. Focal form
 - 2. Temporal lobe epilepsy
 - C. Generalized syndromes
 - 1. Early myoclonic encephalopathy
 - 2. Infantile spasms
 - 3. Lennaux-Gastaut syndrome
- IV. Less well defined syndromes
 - A. Severe myoclonic epilepsy of infancy
 - B. Benign myoclonic epilepsy of infancy
 - C. Epilepsy with myoclonic atstatic seizures
 - D. Epilepsy with myoclonic absences
 - E. Acquired epileptic aphasia (Landau-Kleffner syndrome)
 - F. Epilepsy with continuous spikes and waves during sleep (ESES)
 - G. Reflex epilepsies

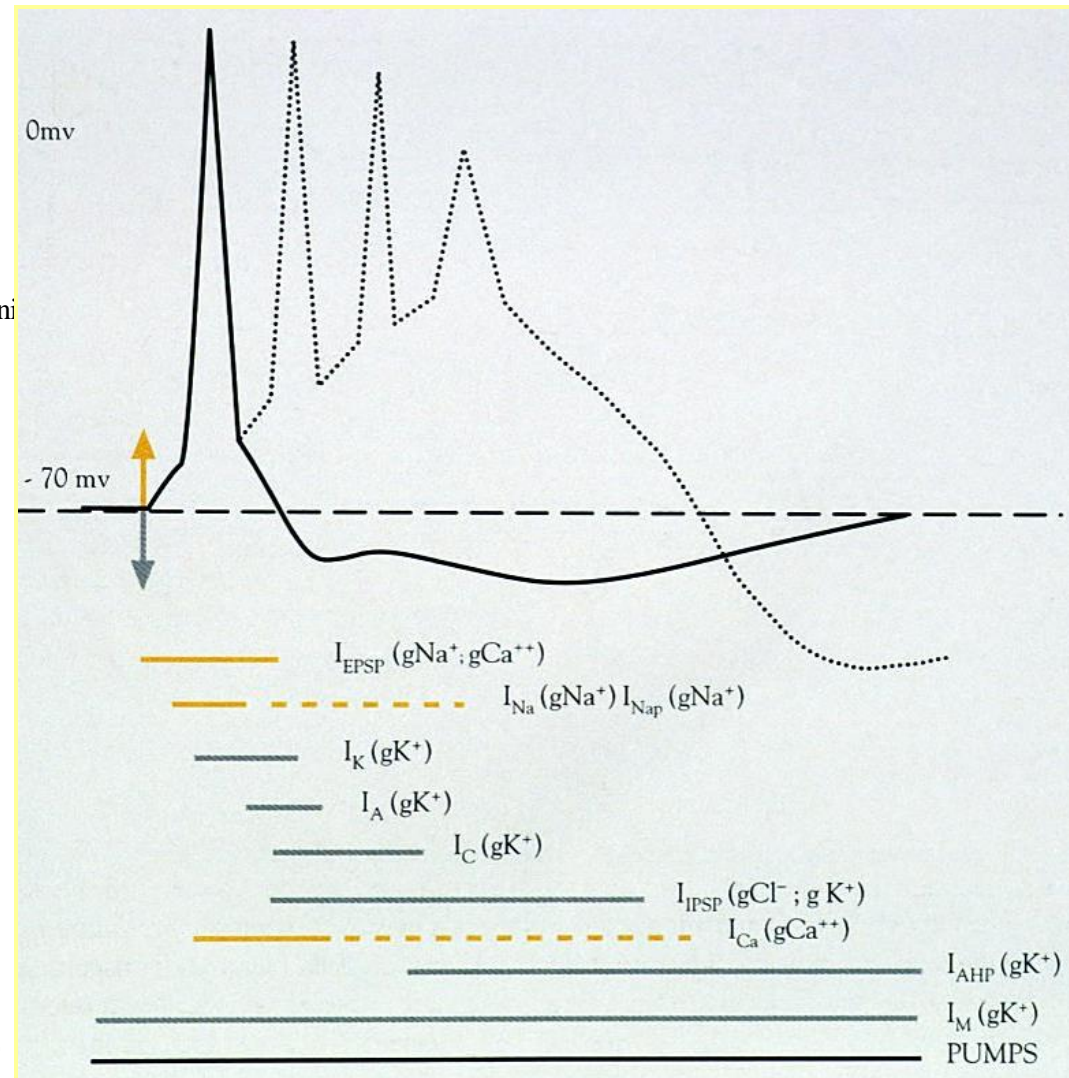

Epileptic Chanelopathies

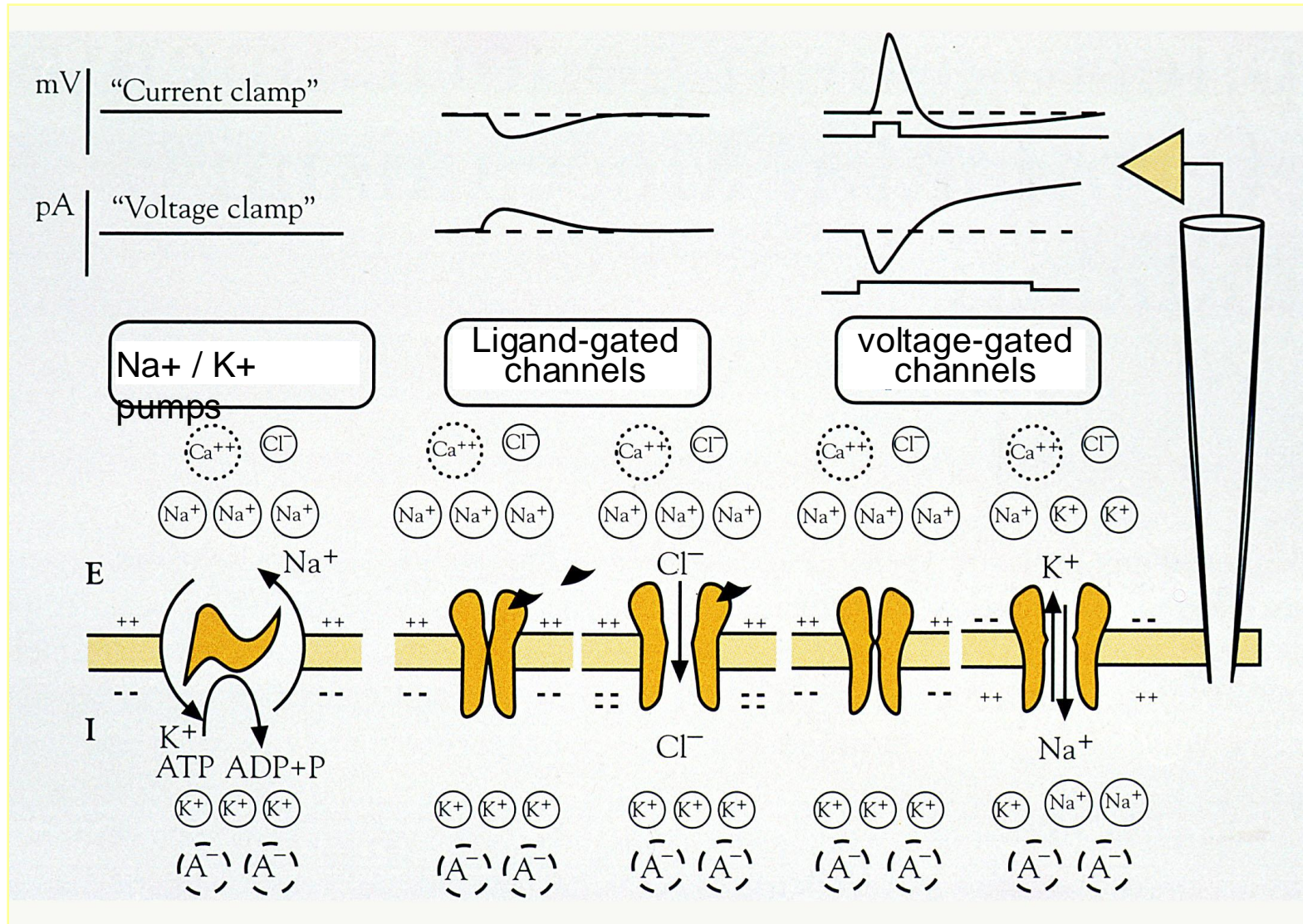

Ion Channels Implicated in Epilepsy

Channel	Protein	Gene	Syndrome
<i>Voltage-gated</i>			
Sodium channel	Type I α_1 subunit	<i>SCN1A</i>	Generalized epilepsy with febrile seizures plus syndrome (GEFS+)
	Type I β_1 subunit	<i>SCN1B</i>	Generalized epilepsy with febrile seizures plus syndrome (GEFS+)
	Type I α_1 subunit	<i>SCN1A</i>	Severe myoclonic epilepsy of infancy (SMEI)
	Type I α_1 subunit	<i>SCN1A</i>	Intractable childhood epilepsy with generalized tonic-clonic seizures (ICEGTCs)
	Type I α_1 subunit Type II α_1 subunit	<i>SCN1A</i> <i>SCN2A</i>	Infantile spasms (IS) Benign familial neonatal-infantile seizures (BFNIS)
Calcium channel	P/Q-type α_1 subunit	<i>CACNA1A</i>	Episodic ataxia type 2 (EA2) Familial hemiplegic migraine (FHM) Spinocerebellar ataxia type 6 (SCA 6)
		<i>CACNB4</i> <i>CACNA1H</i>	Episodic ataxia type 2 (EA2) Childhood absence epilepsy (CAE) ^a
Potassium channel	$K_V1.1$	<i>KCNA1</i>	Episodic ataxia type 1 (EA1)
	M-channel	<i>KCNQ2</i> <i>KCNQ3</i>	Benign familial neonatal convulsions (BFNC)
		BK channel	<i>KCNMA1</i>
Chloride channel	CLC-2	<i>CLCN2</i>	Juvenile myoclonic epilepsy (JME) Juvenile absence epilepsy (JAE) Epilepsy with grand mal seizures on awakening (EGMA) CAE
<i>Ligand-gated</i>			
Acetylcholine receptor	β_2 subunit	<i>CHRNB2</i>	Autosomal dominant frontal lobe epilepsy (ADNFLE)
	α_4 subunit	<i>CHRNA4</i>	
GABA receptor	γ_2 subunit	<i>GABRG2</i>	GEFS+, CAE, SMEI
	α_1 subunit	<i>GABRA1</i>	JME
	β subunit	<i>GABRD</i>	JME ^a

Epileptic Channelopathies

- Rare
- Generalized and focal epilepsies
- Moderate phenotypic variability
- Autosomal Dominant mode of inheritance
- Incomplete penetrance (~ 80%)

Voltage-gated Ca Channels: Subunit Assembly and Subtypes

Ancillary subunits

$\beta_1, \beta_2, \beta_3, \beta_4$

γ_1 through γ_8

$\alpha_2\text{-}\delta_1$ through $\alpha_2\text{-}\delta_4$

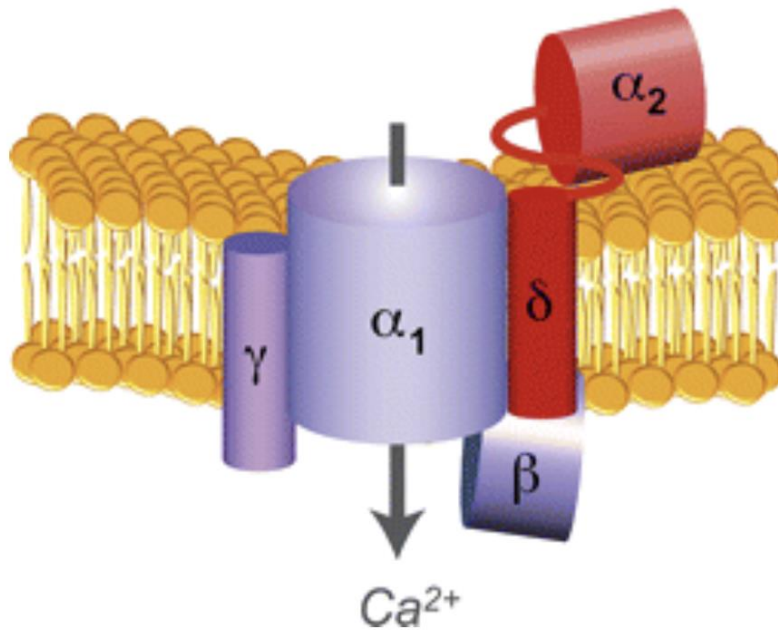

Neuronal α_1 subunits

HVA $\text{Ca}_v1.2$
 $\text{Ca}_v1.3$ } L-type
 $\text{Ca}_v1.4$

$\text{Ca}_v2.1$ P/Q-type
 $\text{Ca}_v2.2$ N-type
 $\text{Ca}_v2.3$ R-type

LVA $\text{Ca}_v3.1$
 $\text{Ca}_v3.2$ } T-type
 $\text{Ca}_v3.3$

Epilepsy: Voltage-gated Ca²⁺ Channel

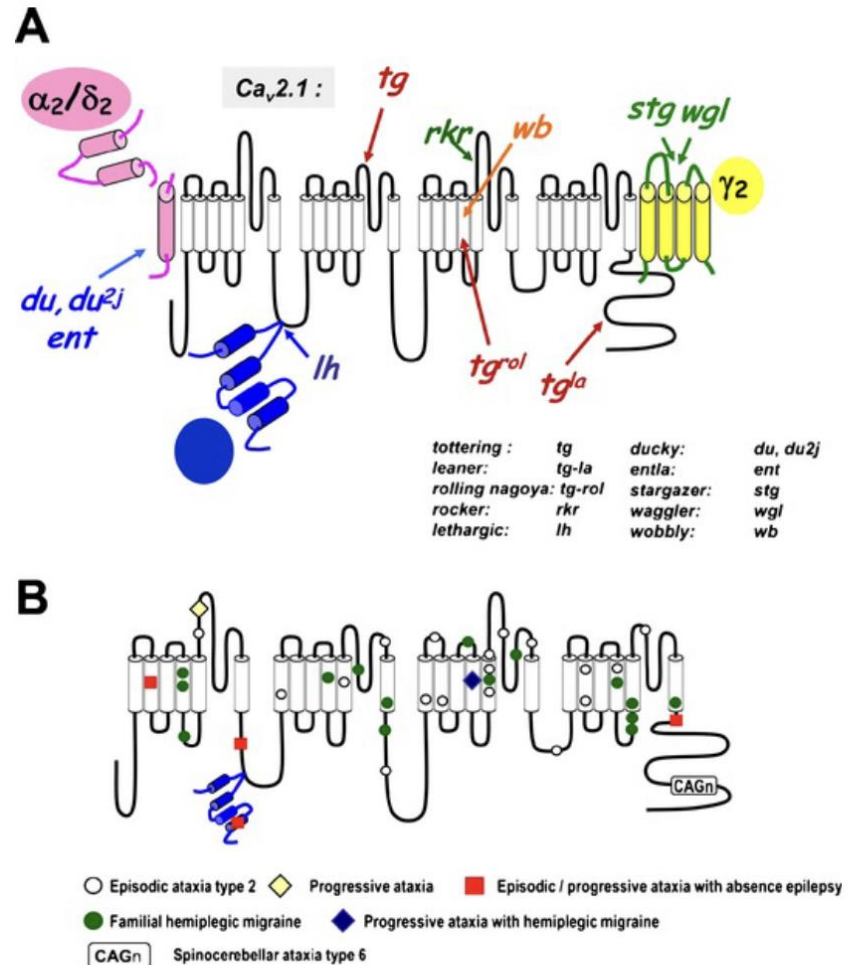
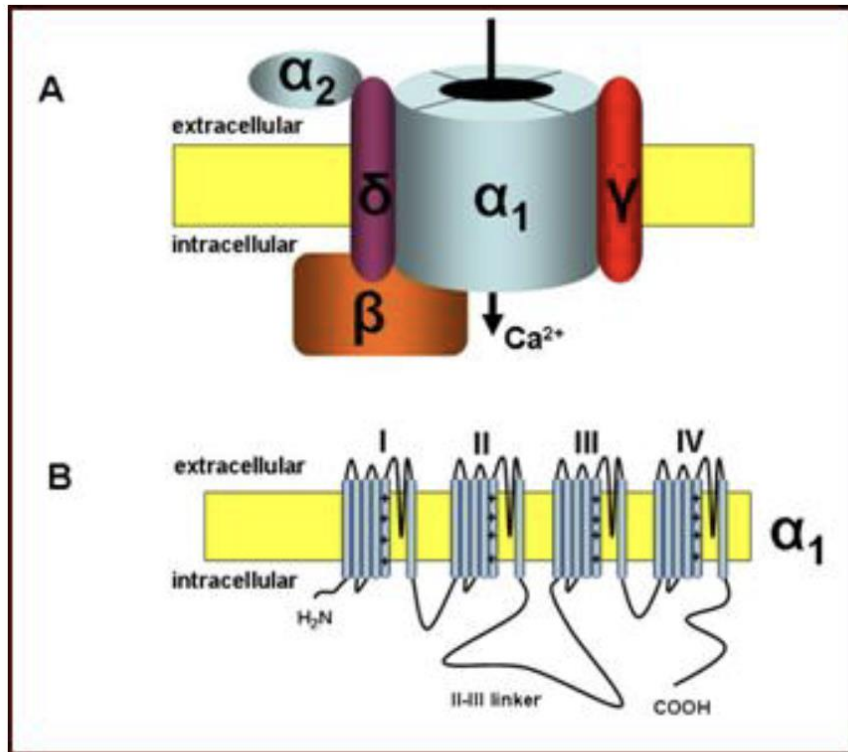

Enhancement of T-type Ca current in thalamocortical networks produces spike wave absence epilepsy

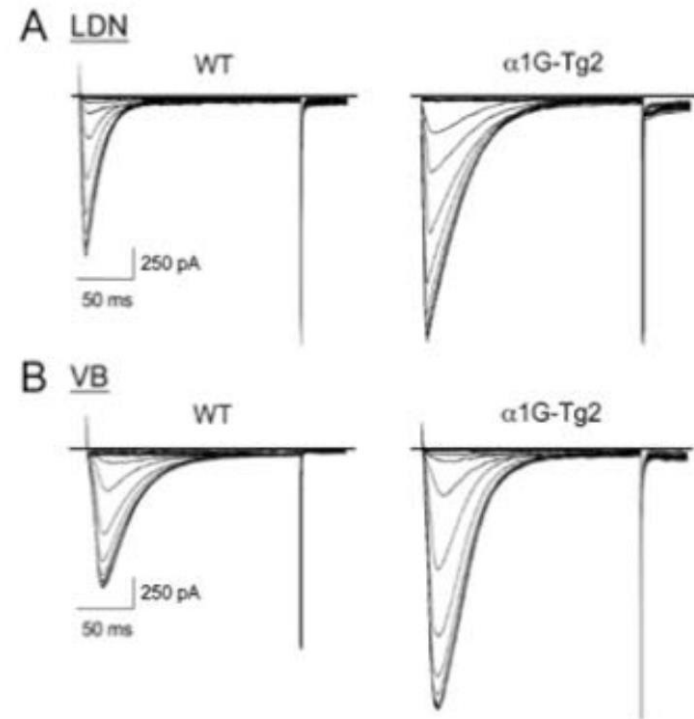
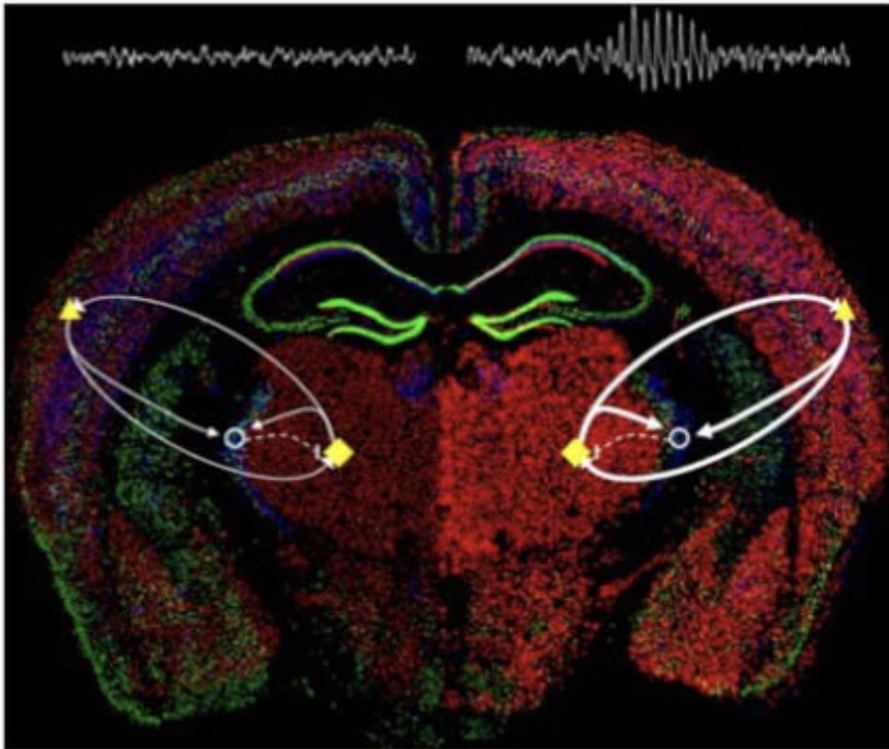

gain-of-function

Voltage-Gated Potassium Channels

Mendelian idiopathic epilepsies

- Age of onset between 2 to 4 days of age
- Partial seizures
 - tonic posture progressing to clonic movements
 - ocular symptoms
 - apneic spells
- Normal interictal EEG
- Ictal EEG showing a sequence of generalized attenuation followed by slow waves, spikes and burst-suppression
- No psychomotor delay or brain lesions
- 10 % risk of febrile convulsions or epilepsy

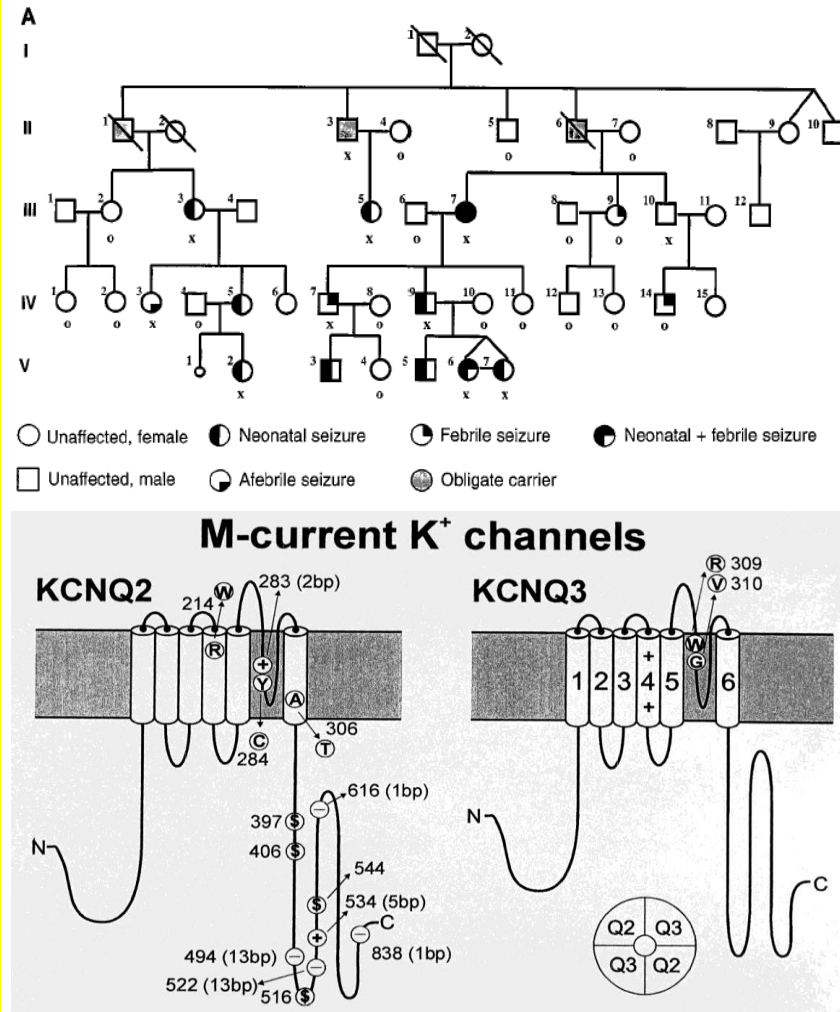

Distribution of KCNQ2 and KCNQ3 in the CNS

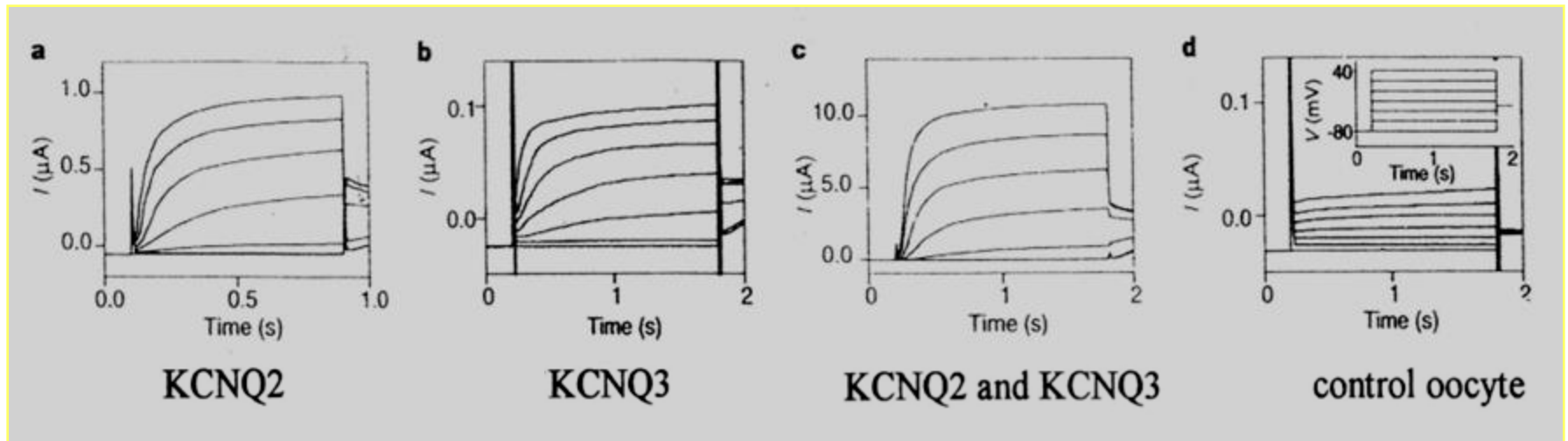
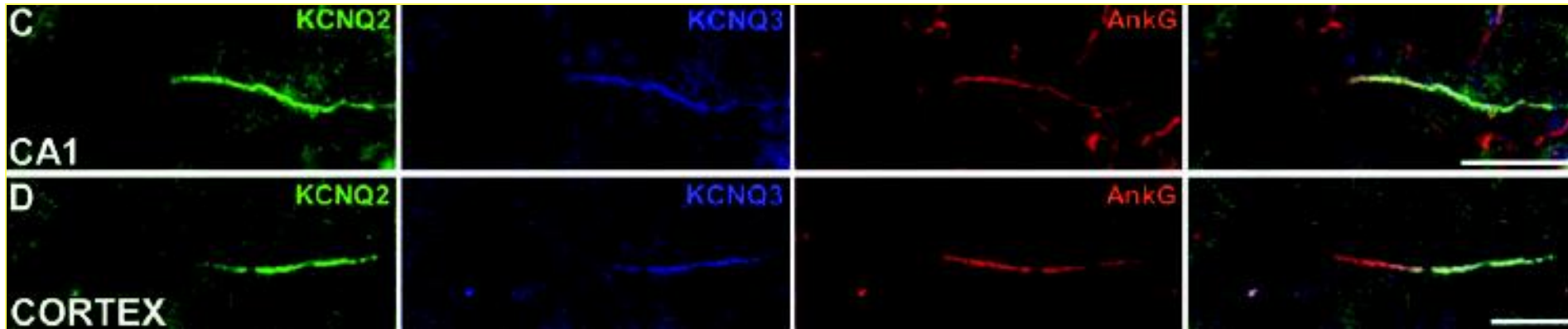

Myokymia and neonatal epilepsy caused by a mutation in the voltage sensor of the KCNQ2 K⁺ channel

Karin Dedek*, Bernhard Kunath†, Colette Kananura‡, Ulrike Reuner†, Thomas J. Jentsch*§, and Ortrud K. Steinlein‡§

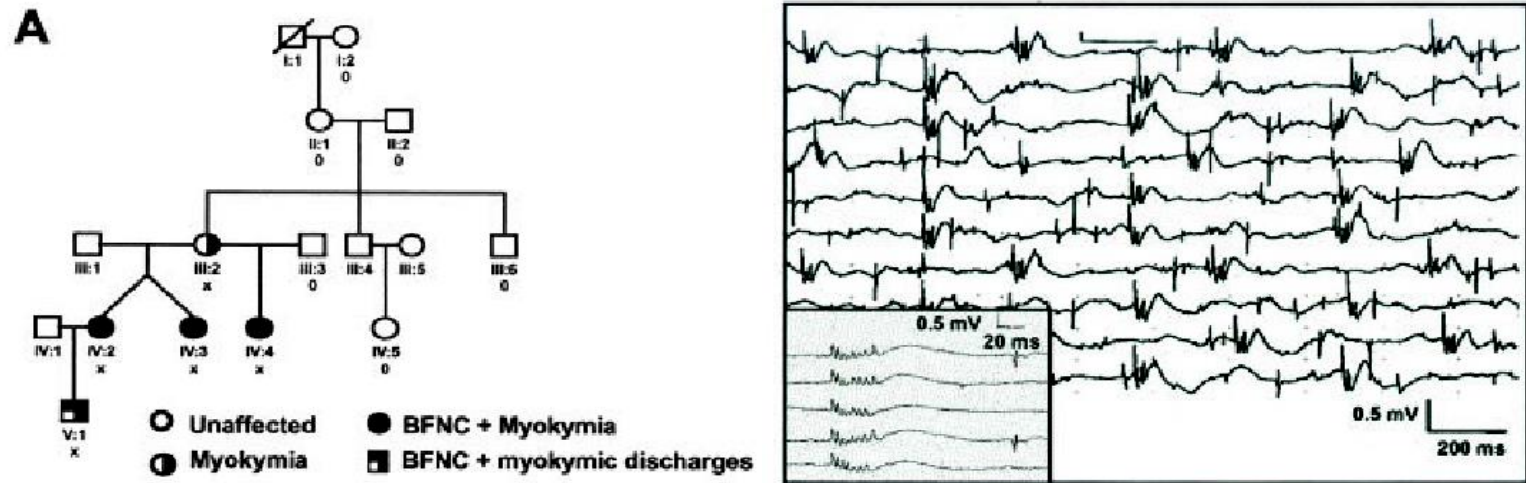

Distribution of KCNQ2 and KCNQ3 in the PNS

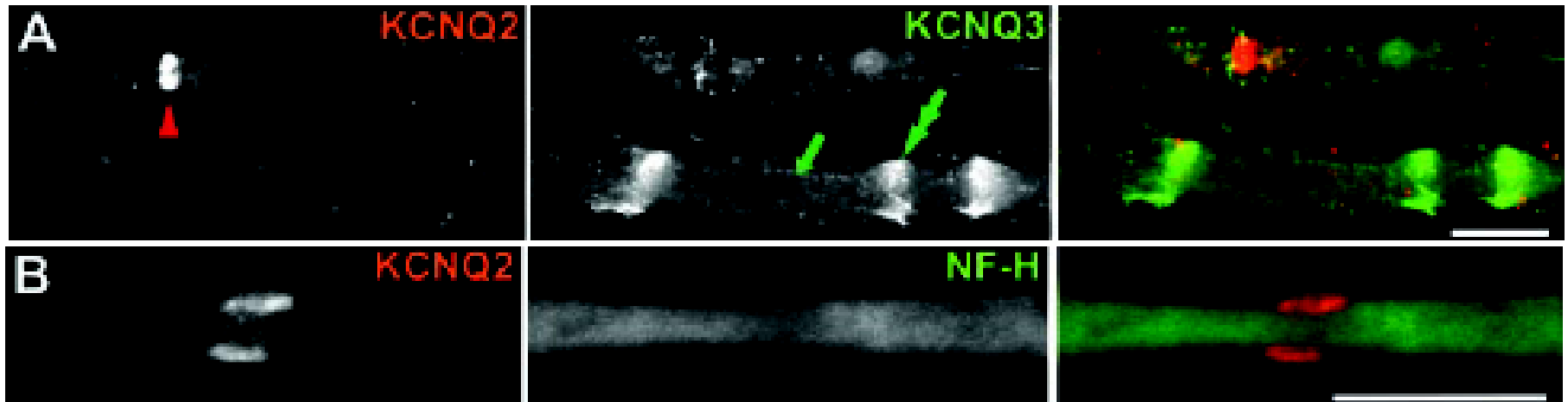

Functional analysis of voltage-gated K⁺ channels

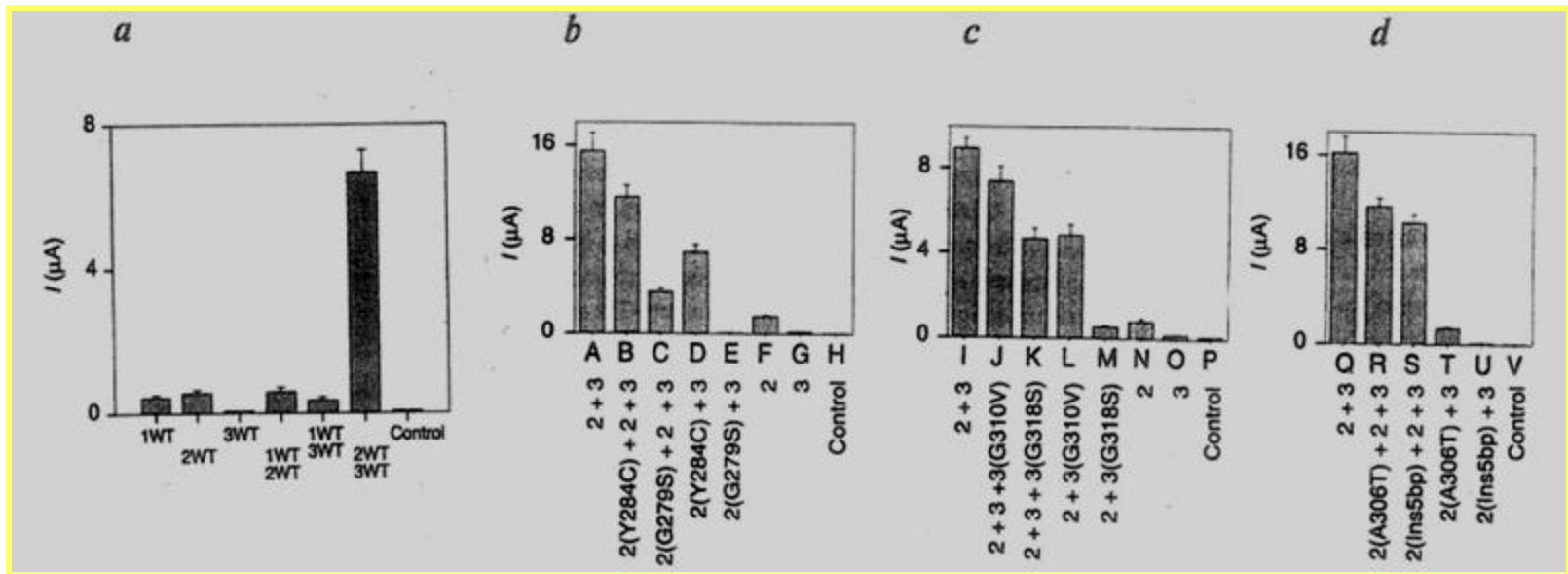

Mendelian idiopathic epilepsies

Variable age of onset (4-40 years, average ~20)

Simple Partial Seizures

Auditory aura (Visual symptoms, aphasia)

Secondarily Generalized Tonic-Clonic Seizures

Seizures sometimes pharmacoresistant

Normal interictal EEG or mild temporal abnormalities

Absence of psychomotor delay or brain lesions

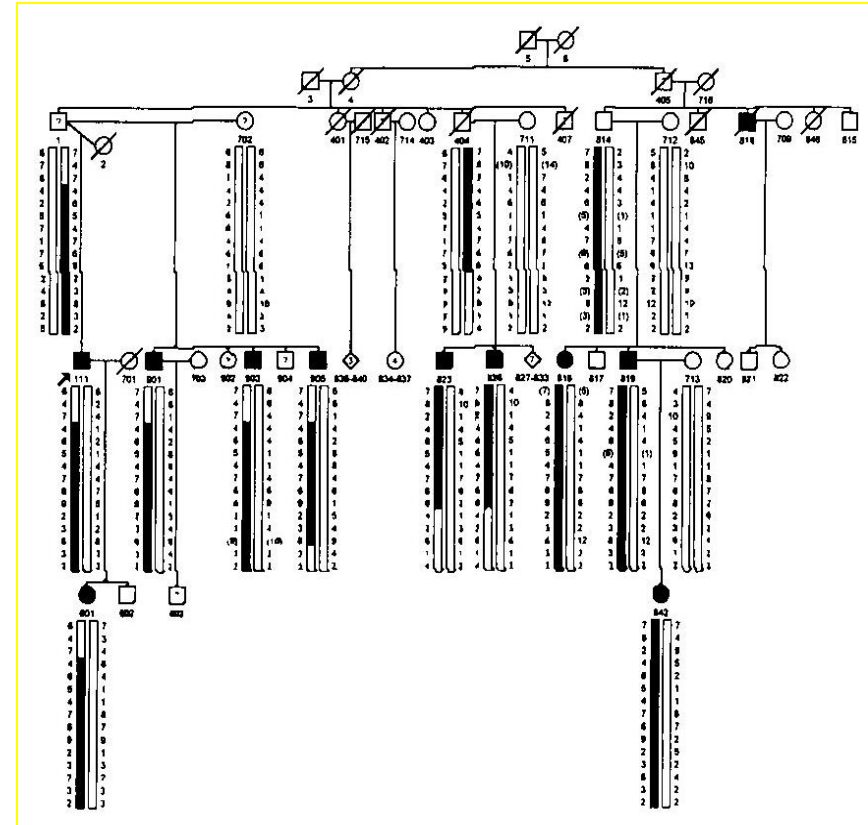

The Epilepsy-Linked Lgi1 Protein Assembles into Presynaptic Kv1 Channels and Inhibits Inactivation by Kv β 1

Uwe Schulte,² Jörg-Oliver Thumfart,¹ Nikolaj Klöcker,¹
 Claudia A. Sailer,^{1,3} Wolfgang Bildl,¹
 Martin Biniösesek,⁵ Doris Dehn,⁴ Thomas Deller,⁴
 Silke Eble,¹ Karen Abbass,² Tanja Wangler,²
 Hans-Günther Knaus,³ and Bernd Fakler^{1,*}

Neuron 49, 697–706, March 2, 2006

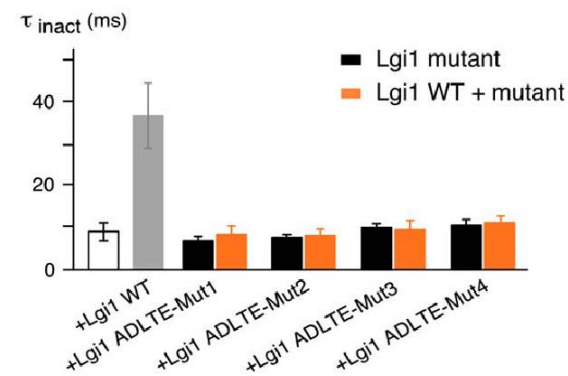
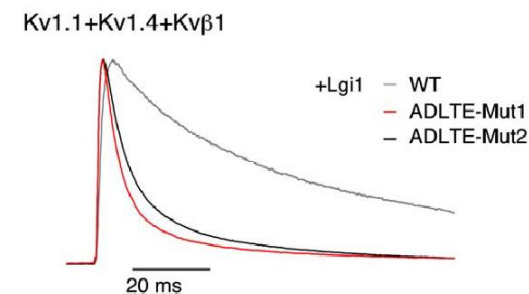
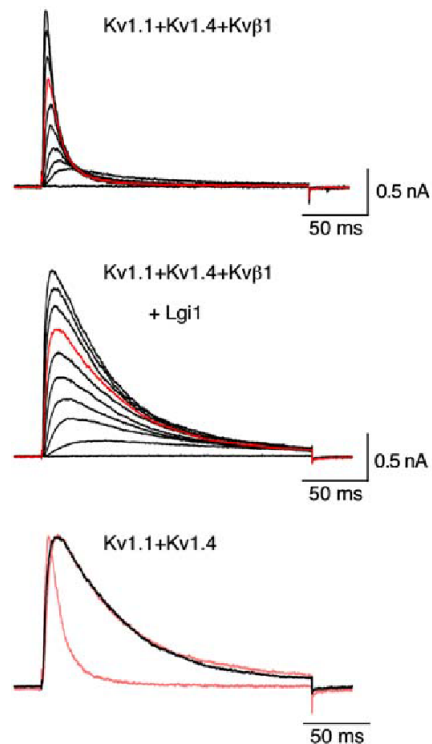
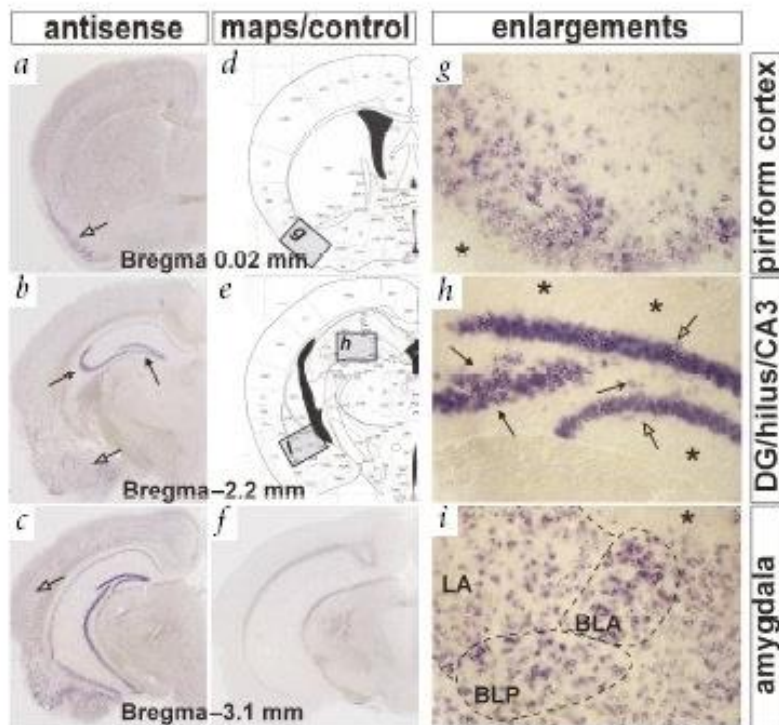

Voltage-Gated Sodium Channels

Generalized Epilepsy and Febrile Seizures plus

Clinical features

- Clinical Variability
- Febrile Seizures (< 6 y)
- Febrile Seizures “plus” (> 6y)
- Afebrile seizures, usually generalized (tonic-clonic, absence, myoclonic, atonic)
- Benign outcome
- No brain lesions or metabolic disorders

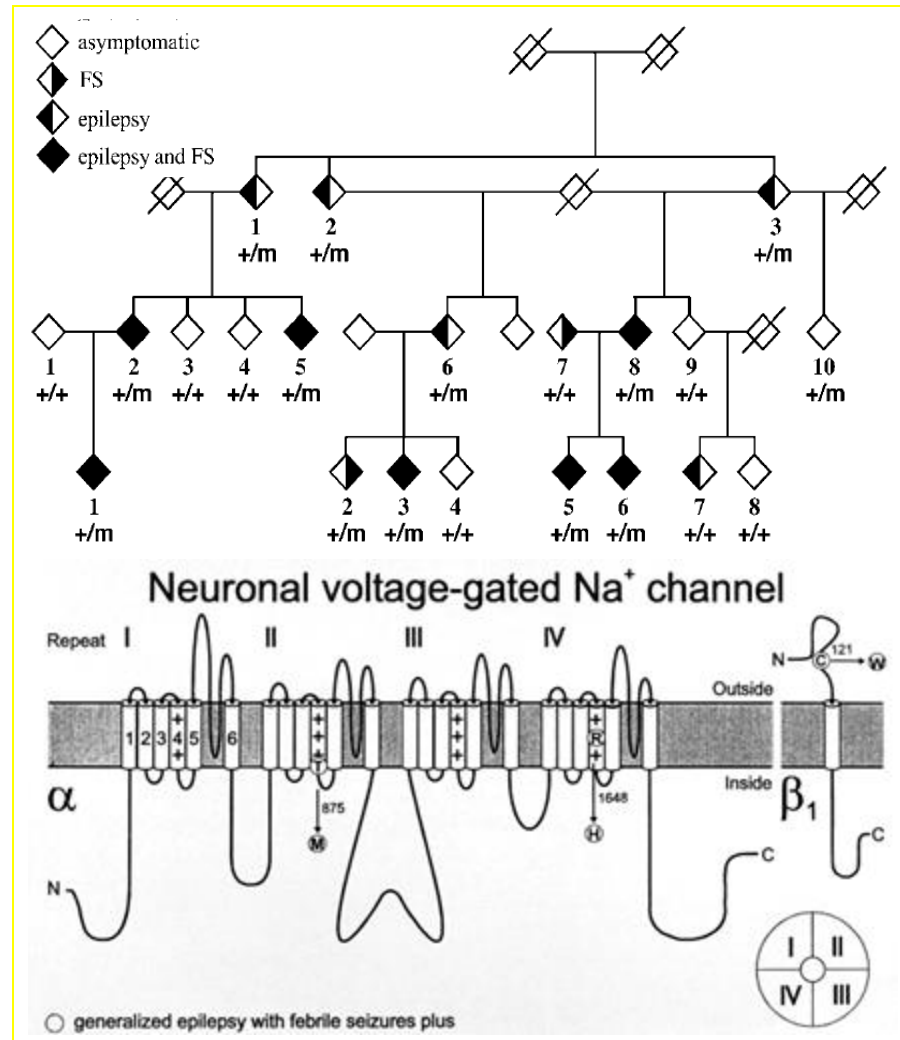

Functional analysis of voltage-gated Na⁺ α1 subunit

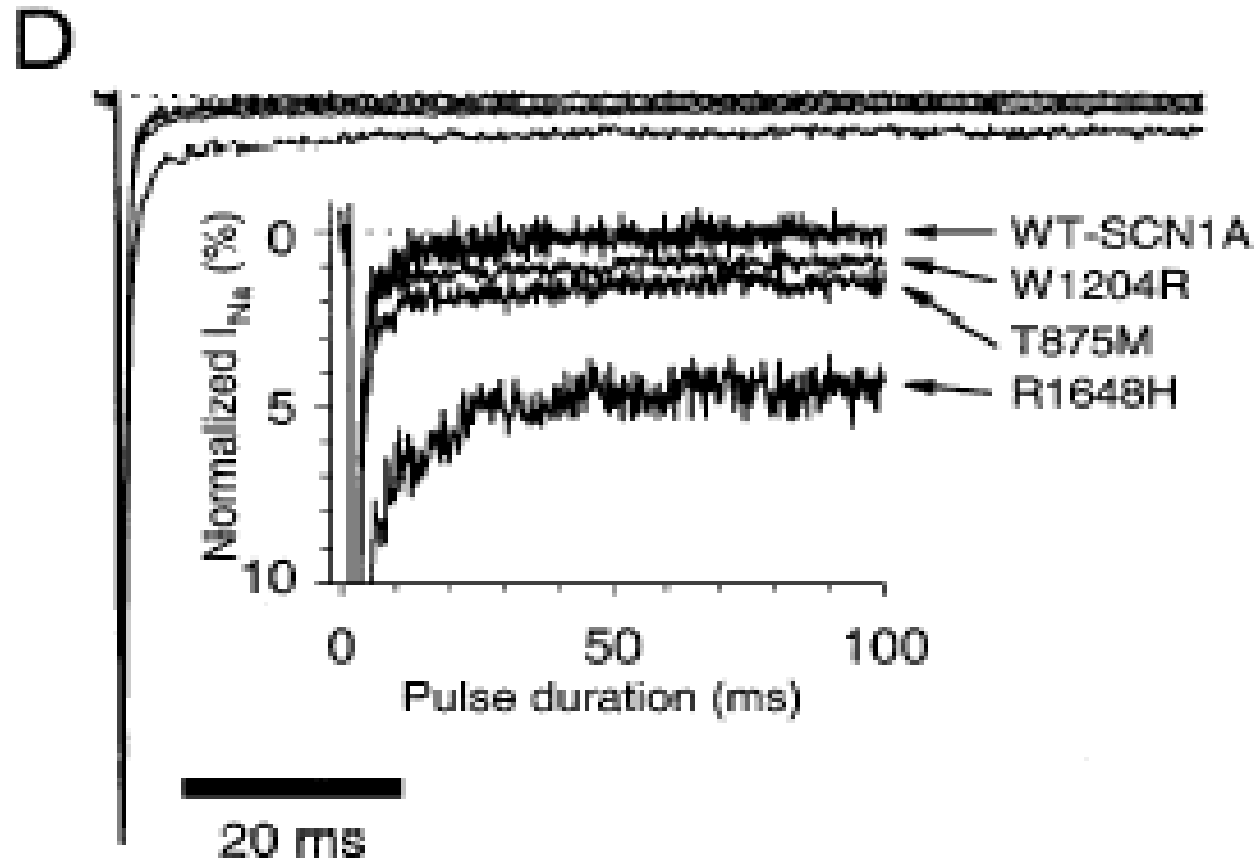

Functional characterization of the D188V mutation in neuronal voltage-gated sodium channel causing generalized epilepsy with febrile seizures plus (GEFS)

Patrick Cossette^{a,1}, Andrew Loukas^{b,1}, Ronald G. Lafrenière^{a,c},
Daniel Rochefort^a, Eric Harvey-Girard^a, David S. Ragsdale^b,
Robert J. Dunn^a, Guy A. Rouleau^{a,*}

Phenotype: GEFS+
Mutation: D188V

cDNA: rat SCN2A
Expression System: Human HEK

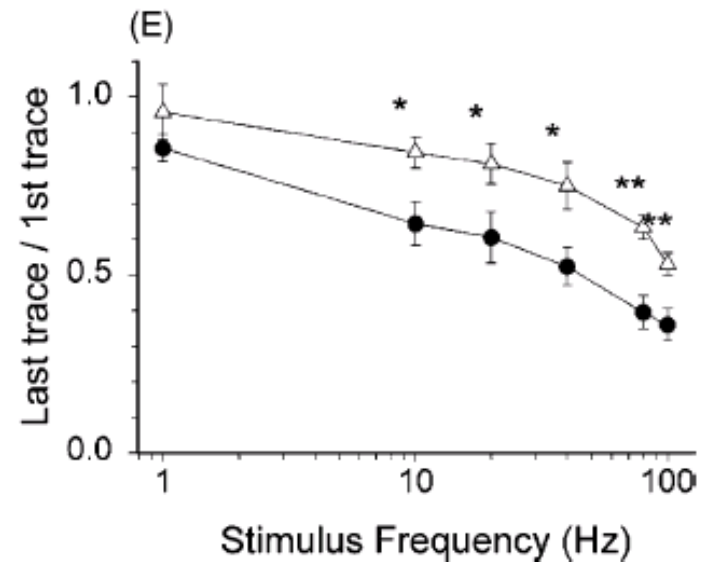
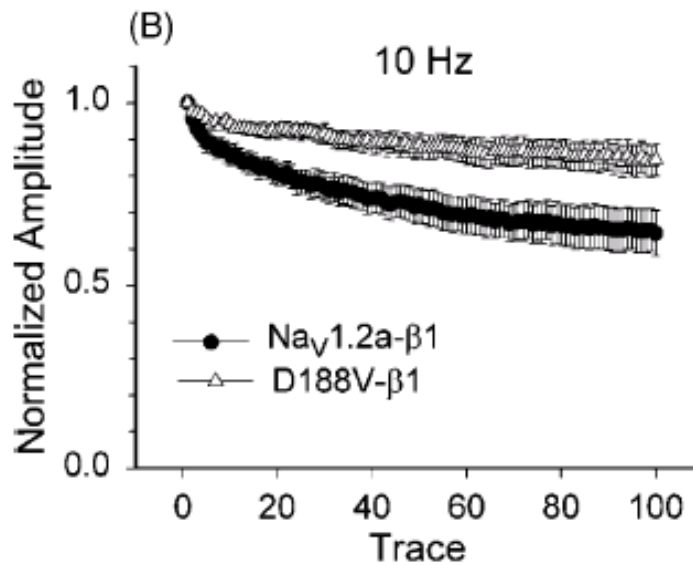

Resistance to cumulative inactivation during high frequency activation,

A Novel Epilepsy Mutation in the Sodium Channel *SCN1A* Identifies a Cytoplasmic Domain for β Subunit Interaction

J. Spanpanato,¹ J. A. Kearney,³ G. de Haan,³ D. P. McEwen,⁴ A. Escayg,³ I. Aradi,² B. T. MacDonald,³ S. I. Levin,³ I. Soltész,² P. Benna,⁵ E. Montalenti,⁵ L. L. Isom,⁴ A. L. Goldin,^{1,2} and M. H. Meisler³

Departments of ¹Microbiology and Molecular Genetics and ²Anatomy and Neurobiology, University of California, Irvine, Irvine, California 92697-4025, Departments of ³Human Genetics and ⁴Pharmacology, University of Michigan, Ann Arbor, Michigan 48109-0618, and ⁵Department of Neurosciences, University of Torino, 10126 Torino, Italy

10022 • The Journal of Neuroscience, November 3, 2004 • 24(44):10022–10034

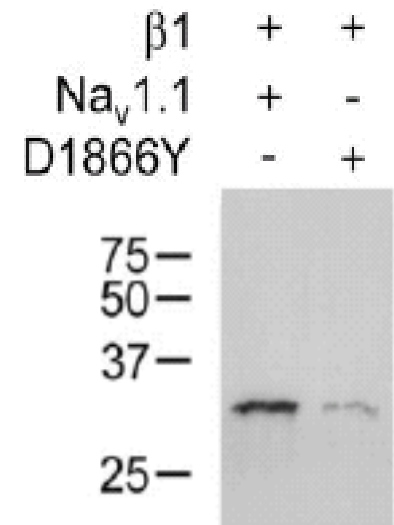
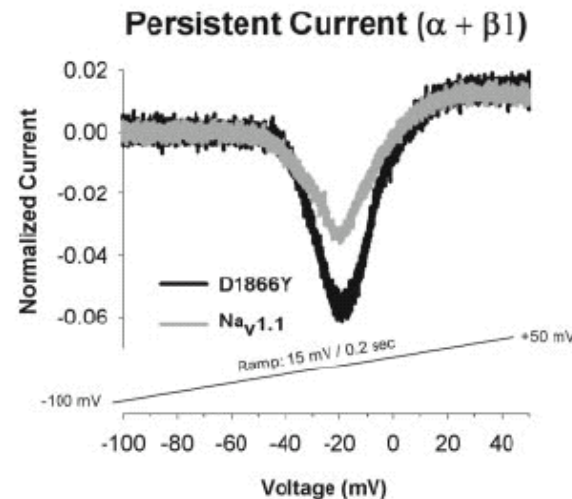
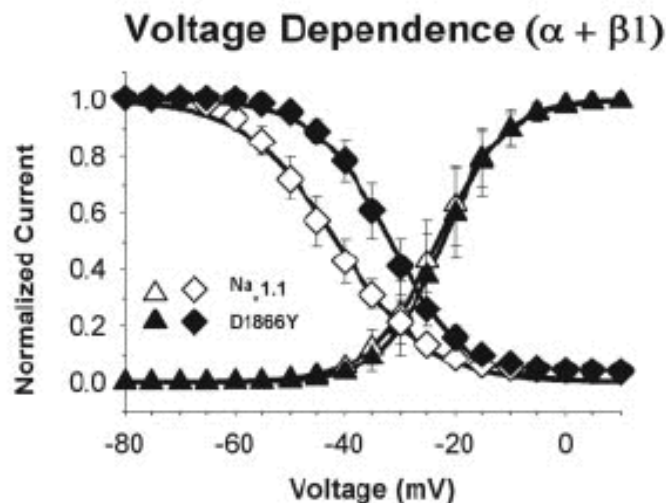

De Novo Mutations in the Sodium-Channel Gene *SCN1A* Cause Severe Myoclonic Epilepsy of Infancy

Lieve Claes,¹ Jurgen Del-Favero,¹ Berten Ceulemans,^{2,3} Lieven Lagae,^{3,4}
Christine Van Broeckhoven,¹ and Peter De Jonghe^{1,2}

¹Department of Molecular Genetics, Flanders Interuniversity Institute for Biotechnology (VIB), University of Antwerp, and ²Department of Neurology, University Hospital Antwerp, Antwerp; ³Epilepsy Center for Children and Youth, Pulderbos, Belgium; and ⁴Department of Child Neurology, University Hospital Gasthuisberg, Leuven, Belgium

DOI: 10.1093/brain/awg053

Brain (2003), **126**, 531–546

Mutations of sodium channel α subunit type 1 (*SCN1A*) in intractable childhood epilepsies with frequent generalized tonic–clonic seizures

Tateki Fujiwara,¹ Takashi Sugawara,² Emi Mazaki-Miyazaki,² Yukitoshi Takahashi,³
Katsuyuki Fukushima,¹ Masako Watanabe,¹ Keita Hara,¹ Tateki Morikawa,¹ Kazuichi Yagi,¹
Kazuhiro Yamakawa² and Yushi Inoue¹

Na_v1.1 channels with mutations of severe myoclonic epilepsy in infancy display attenuated currents

Takashi Sugawara^a, Yuji Tsurubuchi^b, Tateki Fujiwara^c,
Emi Mazaki-Miyazaki^a, Keiichi Nagata^b, Mauricio Montal^d,
Yushi Inoue^c, Kazuhiro Yamakawa^{a,*}

Epilepsy Research 54 (2003) 201–207

^a Laboratory for Neurogenetics, Brain Science Institute, RIKEN, 2-1 Hirosawa, Wako, Saitama 351-0198, Japan

^b Laboratory for Memory and Learning, Brain Science Institute, RIKEN, 2-1 Hirosawa, Wako, Saitama 351-0198, Japan

^c National Epilepsy Center, Shizuoka Medical Institute of Neurological Disorders, 886 Urushiyama, Shizuoka 420-8688, Japan

^d Section of Neurobiology, Division of Biological Sciences, University of California, San Diego, La Jolla, CA 92093, USA

Received 28 January 2003; received in revised form 10 April 2003; accepted 14 April 2003

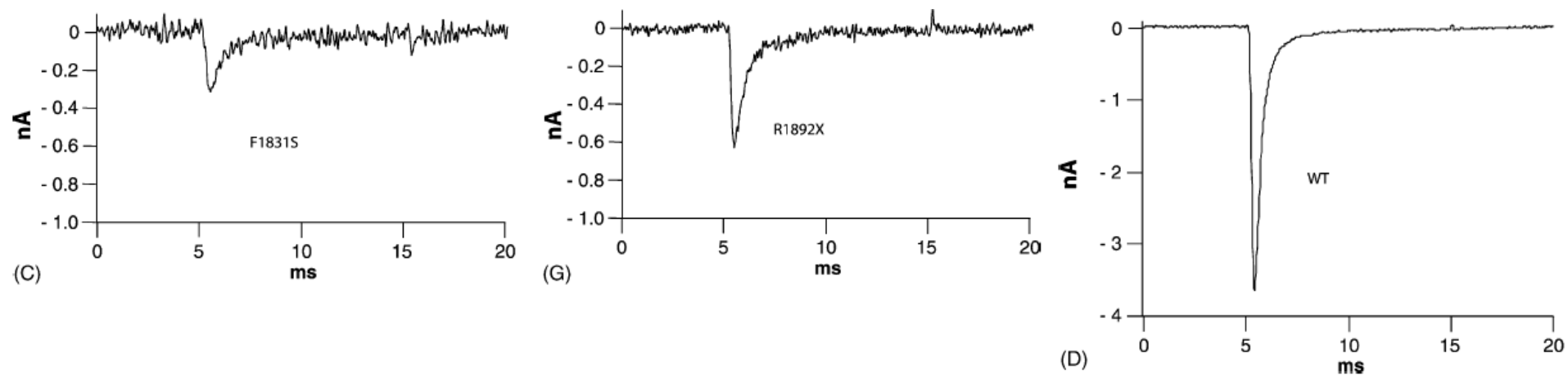

Fig. 2. Representative whole-cell current recordings in HEK293 cells expressing WT human Na_v1.1 channel, and those with SMEI-associated mutations. Currents were evoked from a holding potential of -120 to 0 mV. More than 10 fluorescent-active cells were recorded for each mutant channel, and maximal sodium currents were shown in the figure. (A–C): Mutant channels bearing missense mutations (G979R, N985I, and F1831S). (D): WT control. (E–G): Mutant channels bearing nonsense mutations (R712X, R1407X, and R1892X).

Reduced sodium current in GABAergic interneurons in a mouse model of severe myoclonic epilepsy in infancy

Frank H Yu¹, Massimo Mantegazza^{1,4}, Ruth E Westenbroek¹, Carol A Robbins^{2,3}, Franck Kalume¹, Kimberly A Burton¹, William J Spain³, G Stanley McKnight¹, Todd Scheuer¹ & William A Catterall¹

ΛΟΓΩΝΕ Δ | ΙΠΩΒΕΚ Δ | ΣΕΒΤΕΜΒΕΚ 3009 [NATURE NEUROSCIENCE](#)



Figure 4 Sodium currents from hippocampal neurons in wild-type and heterozygous and null $Na_v1.1$ mice. **(a)** A representative set of sodium current traces from hippocampal pyramidal cells after subtraction of traces recorded in the presence of $1 \mu\text{M}$ tetrodotoxin, which were elicited by depolarizing steps from -60 to -15 mV in 5 -mV increments from a holding potential of -100 mV. **(b)** Representative bright-field view of hippocampal neurons that were acutely dissociated from P14 wild-type mice. The pyramidal-shaped and bipolar-shaped neurons are indicated with arrows. **(c)** Same hippocampal neurons as in **b** but after immunocytochemical processing and staining with anti-GAD. The bipolar-shaped cells, but not the pyramidal-shaped cells, were strongly labeled, which indicates that they are GABAergic inhibitory interneurons.

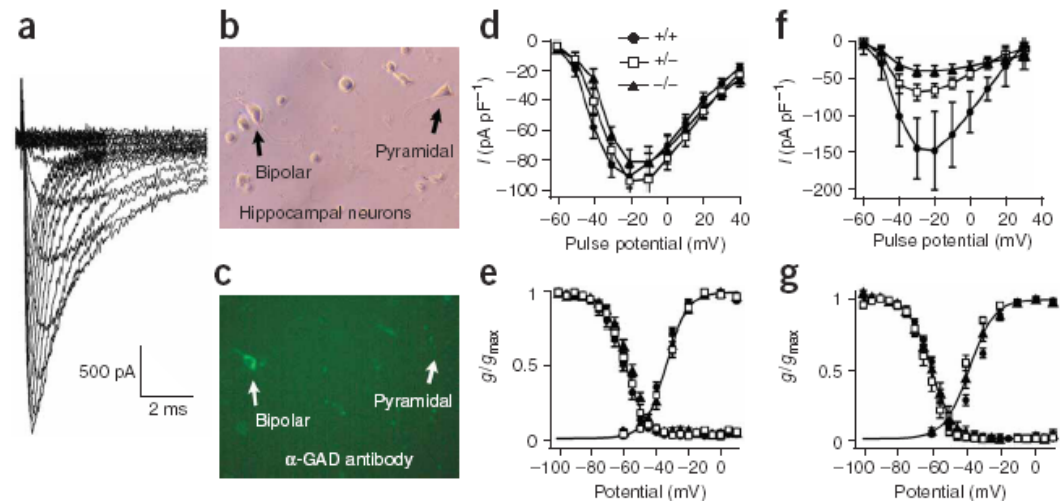

(d, f) Current density–voltage relationships of whole-cell sodium currents from hippocampal pyramidal (**d**) and bipolar (**f**) neurons for wild-type, heterozygous and homozygous mice. Currents of heterozygous and homozygous bipolar neurons were significantly smaller than those of wild-type neurons ($P < 0.05$). **(e, g)** Voltage dependence of activation (right curves) and steady-state inactivation (left curves) of sodium currents from hippocampal pyramidal (**e**) and bipolar (**g**) neurons. Same symbols for mouse genotypes as in **d**. Error bars are s.e.m.

Reduced sodium current in GABAergic interneurons in a mouse model of severe myoclonic epilepsy in infancy

Frank H Yu¹, Massimo Mantegazza^{1,4}, Ruth E Westenbroek¹, Carol A Robbins^{2,3}, Franck Kalume¹, Kimberly A Burton¹, William J Spain³, G Stanley McKnight¹, Todd Scheuer¹ & William A Catterall¹

ΛΟΓΩΣΕ Δ | ΙΚΩΒΕΚ Δ | ΣΕΒΛΕΜΒΕΚ ΣΟΟΡ [NATURE NEUROSCIENCE](#)

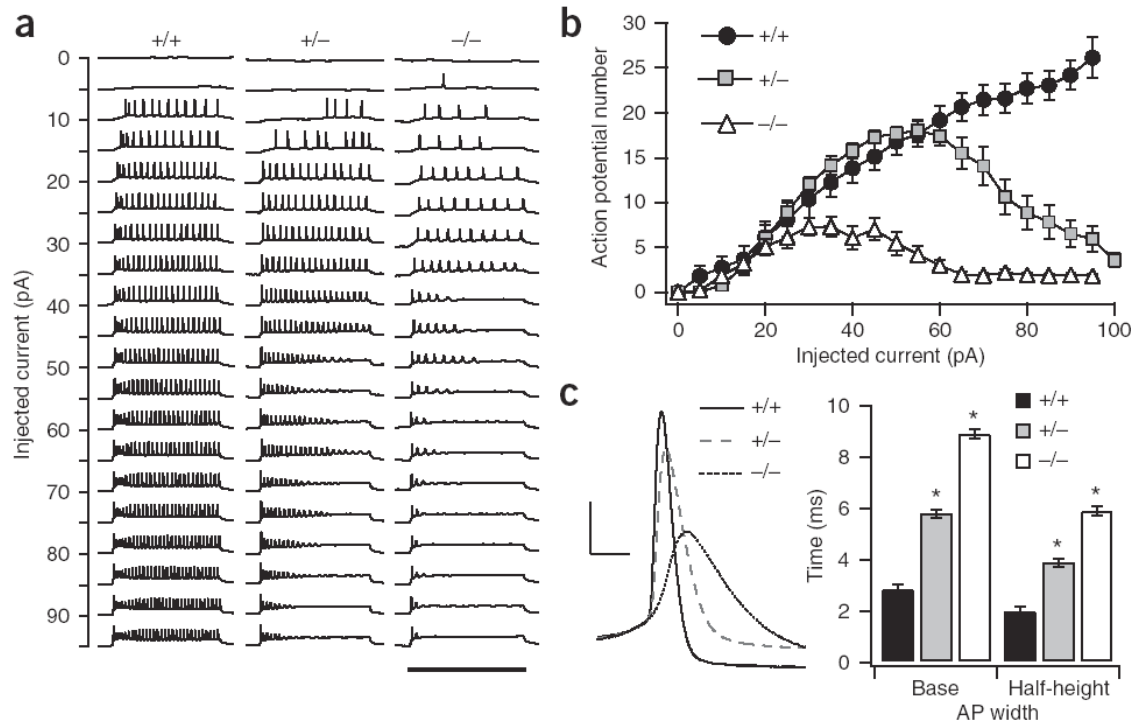
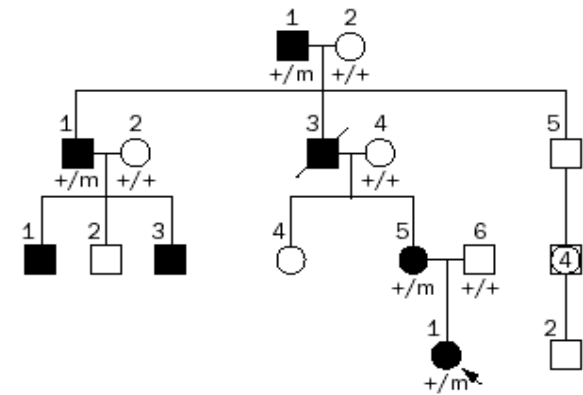

Figure 5 Depolarization-evoked firing activity of hippocampal interneurons from $Na_v1.1$ mutant mice. **(a)** Representative sets of action potential traces recorded from wild-type (+/+), heterozygous (+/-) and homozygous (-/-) interneurons during application of 800-ms injections of depolarizing current in +10-pA increments, from a holding potential of -80 mV. **(b)** Input-output relationship of the number of action potentials elicited versus the injected current. **(c)** Left panel, representative single action potentials recorded for each genotype of interneurons elicited by the same injected current amplitude (35 pA). Right panel, summary bar graph of action potential width and half-width, which are respectively defined as the width at the base and half-maximum amplitude of the action potential. Action potential parameters are listed in **Supplementary Table 1**. Error bars are s.e.m. * $P < 0.01$.

Mendelian idiopathic epilepsies

- Age of onset between 2 days and 6 months of age
- Partial seizures, usually in cluster
 - psychomotor arrest
 - slow deviation of the head and eyes to one side
 - asynchronous limb jerks
- Normal interictal EEG
- Ictal EEG showing a recruiting rhythm with central-occipital region outset and secondary generalization
- Absence of psychomotor delay or brain lesions



SCN2A

Voltage-gated sodium

channel $\alpha 2$ subunit

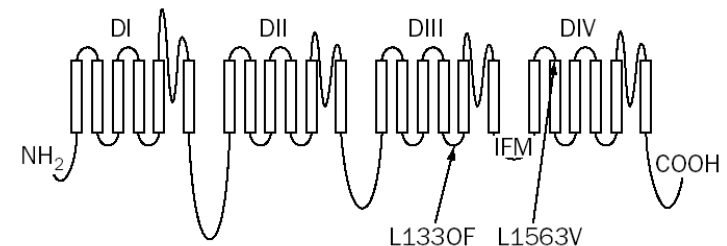

Effects in Neocortical Neurons of Mutations of the $\text{Na}_v1.2 \text{ Na}^+$ Channel causing Benign Familial Neonatal-Infantile Seizures

The Journal of Neuroscience, October 4, 2006 • 26(40):10100–10109

Paolo Scalmani,¹ Raffaella Rusconi,¹ Elena Armatura,¹ Federico Zara,² Giuliano Avanzini,¹ Silvana Franceschetti,¹ and Massimo Mantegazza¹

¹Department of Neurophysiopathology, Istituto Neurologico C. Besta, 20133 Milan, Italy, and ²Laboratory of Neurogenetics, Unit of Muscular and Neurodegenerative Disease, Istituto G. Gaslini, University of Genova, 16147 Genova, Italy

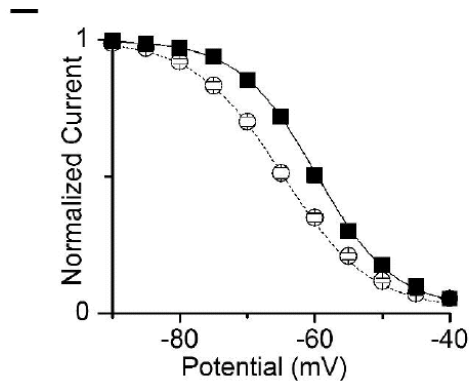

Figure 5. Functional effects of the mutation L1330F. E, mean voltage dependence of inactivation (solid for L1330F, dashed for wild type Nav1.2).

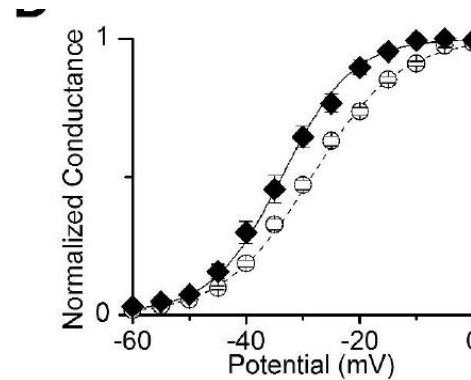

Figure 6. Functional effects of the mutation L1563V. D, mean voltage dependence of activation (solid for L1563V, dashed for wild type Nav1.2).

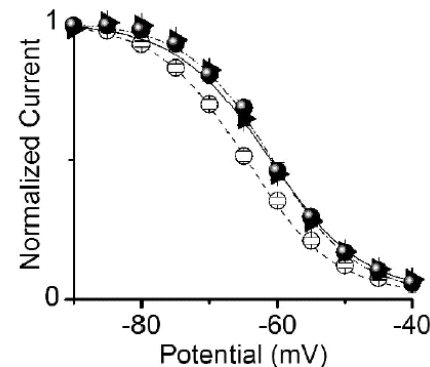
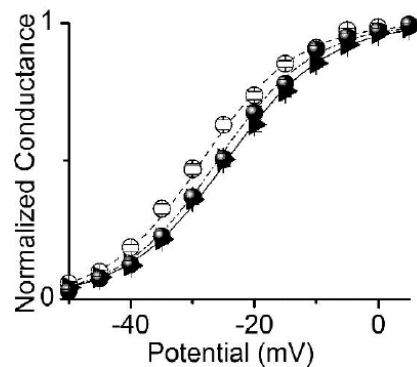

Figure 7. Functional effects of the mutations R223Q and R1319Q. D, mean voltage dependence of activation E, mean voltage dependence of inactivation (solid for R223Q, dashed-dotted for R1319Q and dashed for wild type Nav1.2).

Effects in Neocortical Neurons of Mutations of the $\text{Na}_v1.2 \text{ Na}^+$ Channel causing Benign Familial Neonatal-Infantile Seizures

The Journal of Neuroscience, October 4, 2006 • 26(40):10100–10109

Paolo Scalmani,¹ Raffaella Rusconi,¹ Elena Armatura,¹ Federico Zara,² Giuliano Avanzini,¹ Silvana Franceschetti,¹ and Massimo Mantegazza¹

¹Department of Neurophysiopathology, Istituto Neurologico C. Besta, 20133 Milan, Italy, and ²Laboratory of Neurogenetics, Unit of Muscular and Neurodegenerative Disease, Istituto G. Gaslini, University of Genova, 16147 Genova, Italy

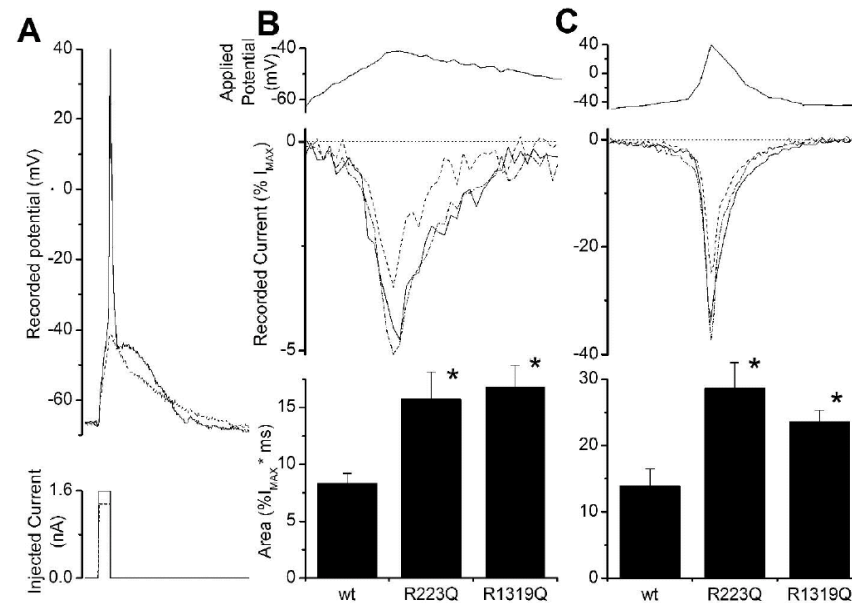
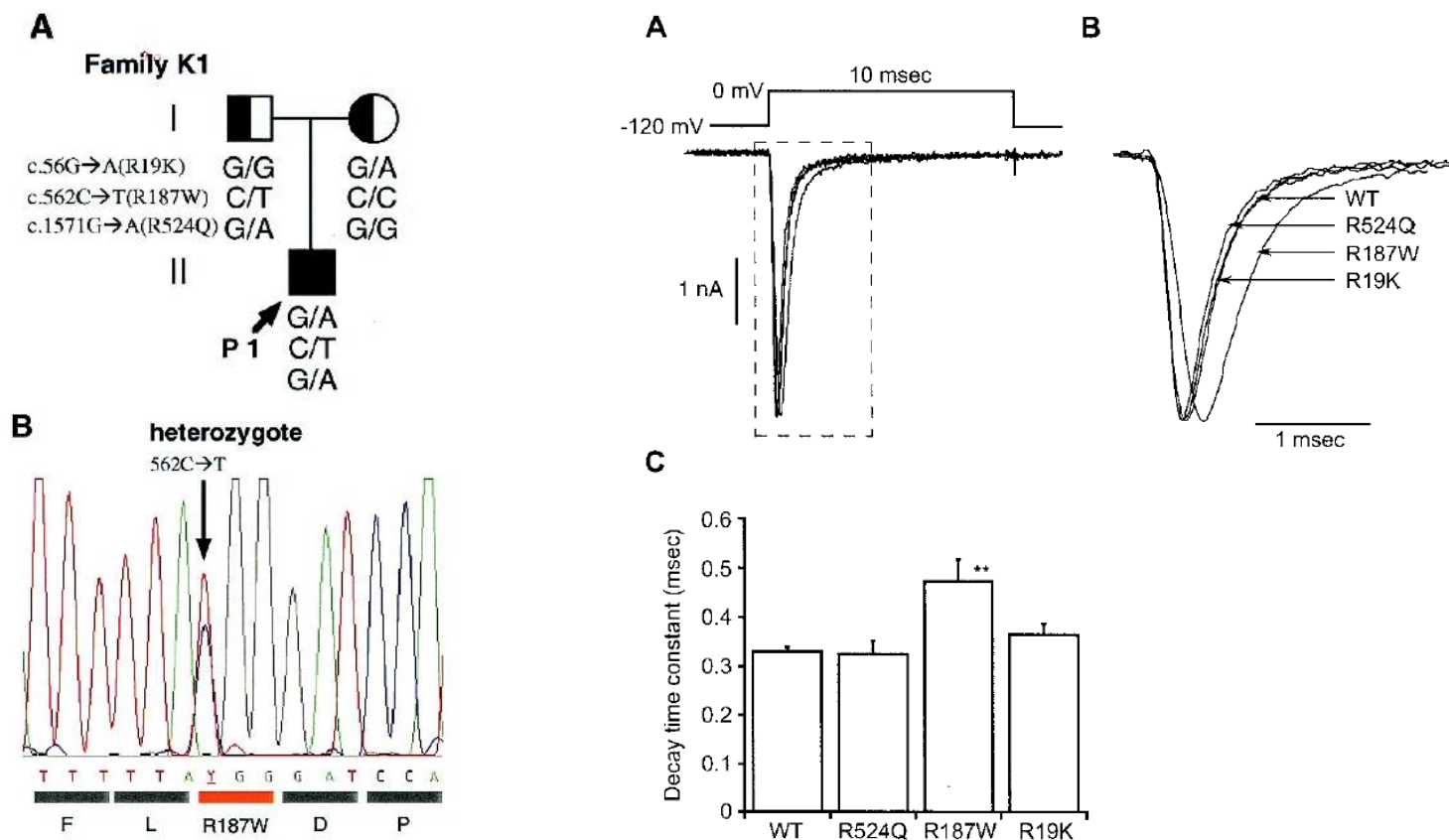

Figure 8. Functional effects of the mutations R223Q and R1319Q studied with physiological voltage stimuli. A, action potential and subthreshold response recorded with sharp microelectrodes in a Layer V neuron in neocortical slices, the lower panel is the injected depolarizing current pulse; scale bar 10ms. **B**, currents elicited in transfected neurons by the subthreshold response shown in **A**; the upper panel shows the subthreshold response used as voltage stimulus; the middle panel shows the recorded subthreshold currents (solid line for R223Q, dashed-dotted line for R1319Q and dashed line for wild type $\text{Nav}1.2$), scale bar 1ms; the bar-graph in the lower panel shows the comparison between the area subtended by the subthreshold currents (see also table 2). **C**, currents elicited in transfected neurons by the action potential shown in **A**; the upper panel shows the action potential used as voltage stimulus; the middle panel shows the recorded action currents (solid line for R223Q, dashed-dotted line for R1319Q and dashed line for wild type $\text{Nav}1.2$), scale bar 1ms; the bar-graph in lower panel shows the comparison between the area subtended by the action currents recorded in the three conditions (see also table2).

A missense mutation of the Na⁺ channel α_{II} subunit gene *Nav1.2* in a patient with febrile and afebrile seizures causes channel dysfunction

Takashi Sugawara*, Yuji Tsurubuchi[†], Kishan Lal Agarwala*, Masatoshi Ito[‡], Goryu Fukuma[§], Emi Mazaki-Miyazaki*, Hiroshi Nagafuji[¶], Masaharu Noda^{||}, Keiji Imoto^{**}, Kazumaru Wada^{††}, Akihisa Mitsudome[§], Sunao Kaneko^{††}, Mauricio Montal^{††}, Keiichi Nagata[†], Shinichi Hirose^{§,§§}, and Kazuhiro Yamakawa^{*,§§}

6384–6389 | PNAS | May 22, 2001 | vol. 98 | no. 11



A Nonsense Mutation of the Sodium Channel Gene *SCN2A* in a Patient with Intractable Epilepsy and Mental Decline

Kazusaku Kamiya,¹ Makoto Kaneda,² Takashi Sugawara,¹ Emi Mazaki,¹ Nami Okamura,¹ Mauricio Montal,³ Naomasa Makita,⁴ Masaki Tanaka,⁵ Katsuyuki Fukushima,⁵ Tateki Fujiwara,⁵ Yushi Inoue,⁵ and Kazuhiro Yamakawa¹

2690 • The Journal of Neuroscience, March 17, 2004 • 24(11):2690–2698

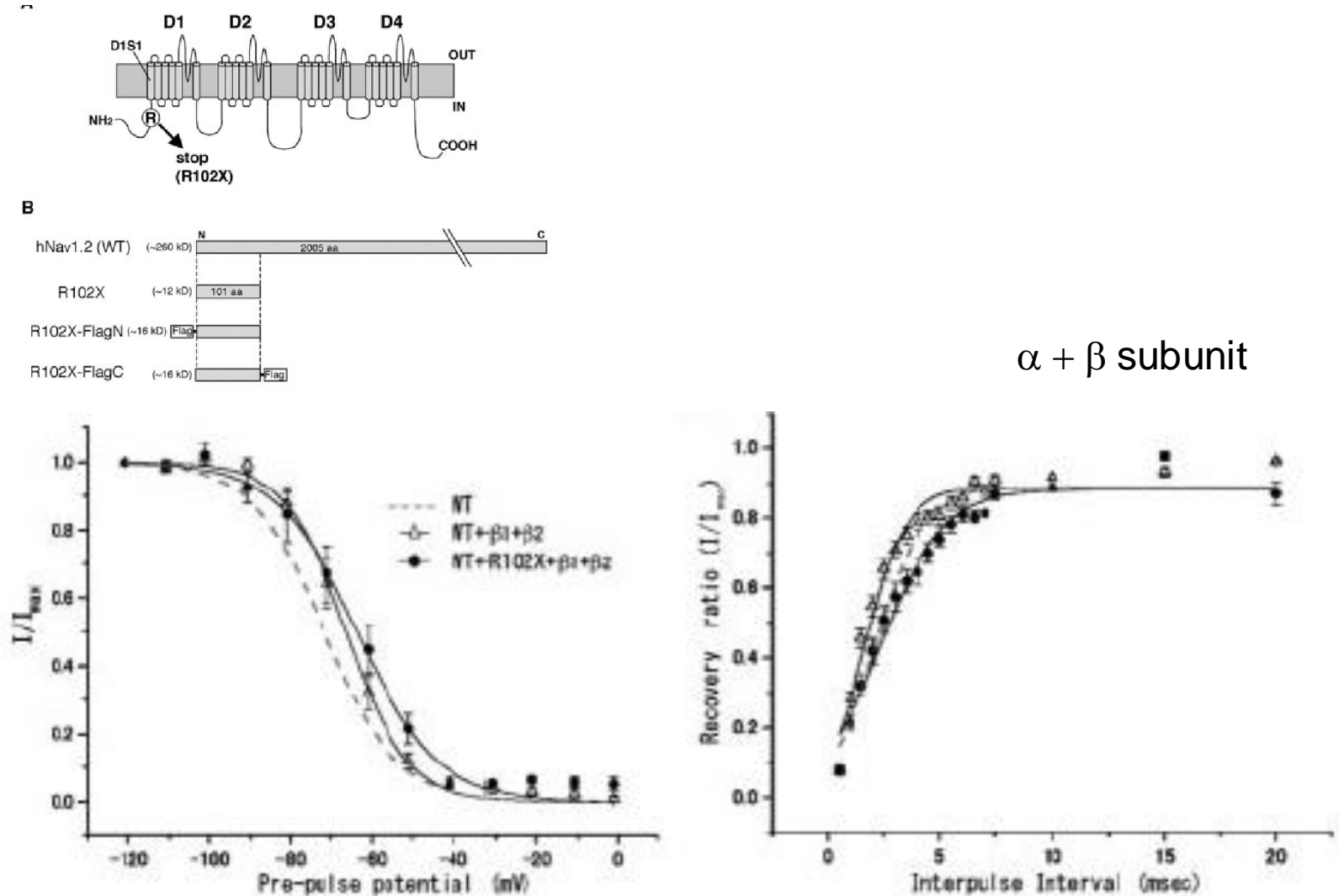

Voltage-Gated Chloride Channels

I. Reactive syndromes

- A. Neonatal seizures due to reversible causes
- B. Benign febrile convulsions
- C. “Low threshold” reactive seizures

II. Idiopathic syndromes

A. Benign Neonatal convulsions

- I. Familial
- 2. Non familial

B. Partial syndromes

- 1. Benign childhood epilepsy with centrotemporal spikes
- 2. Childhood epilepsy with occipital paroxysms

C. Generalized syndromes

- 1. Childhood absence epilepsy (CAE)
- 2. Juvenile absence epilepsy (JAE)
- 3. Epilepsy with generalized tonic-clonic seizures on awakening (EGMA)
- 4. Juvenile absence epilepsy (JME)

III. Symptomatic syndromes

A. Neonatal seizures due to irreversible causes

B. Partial syndromes

- 1. Epilepsia partialis continua (Kojewnikow’s syndrome)
 - a. Encephalopathic form (Rasmussen’s syndrome)
 - b. Focal form

2. Temporal lobe epilepsy

C. Generalized syndromes

- 1. Early myoclonic encephalopathy
- 2. Infantile spasms
- 3. Lennax-Gastaut syndrome

IV. Less well defined syndromes

- A. Severe myoclonic epilepsy of infancy
- B. Benign myoclonic epilepsy of infancy
- C. Epilepsy with myoclonic atstatic seizures
- D. Epilepsy with myoclonic absences
- E. Acquired epileptic aphasia (Landau-Kleffner syndrome)
- F. Epilepsy with continuous spikes and waves during sleep (ESES)
- G. Reflex epilepsies

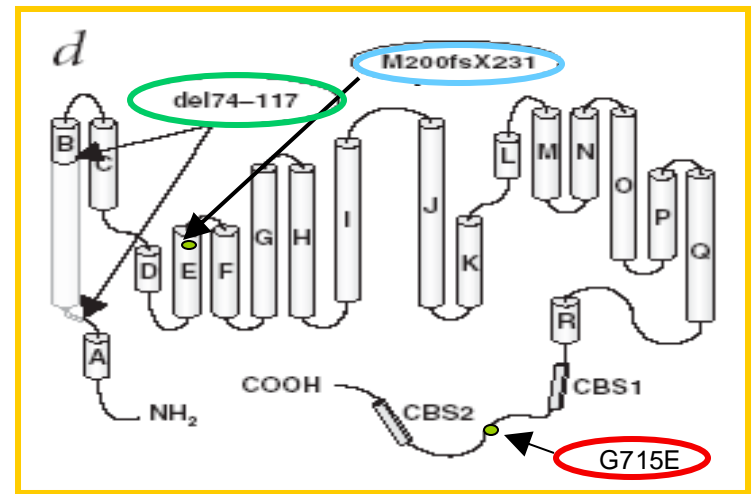

Voltage-gated chloride channel type 2 (CLCN2)

Functional analysis of CLCN2

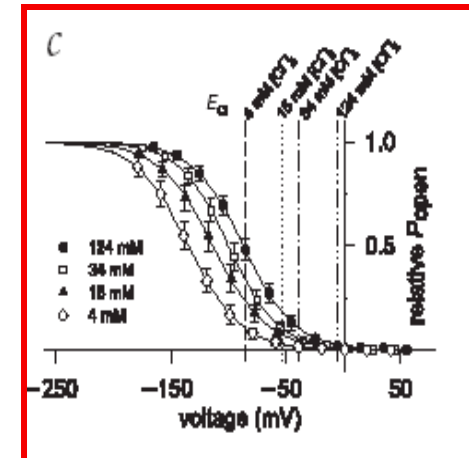
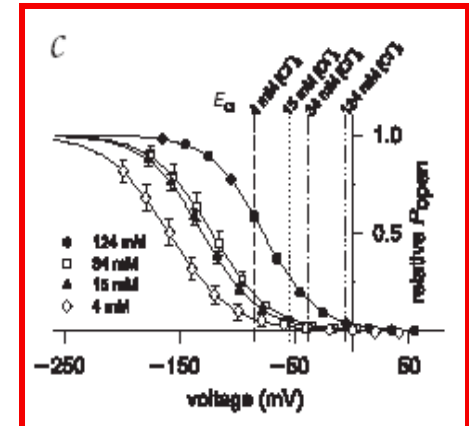
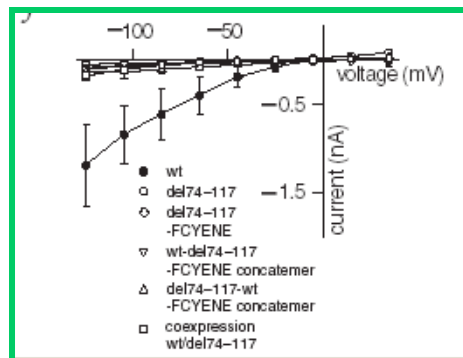
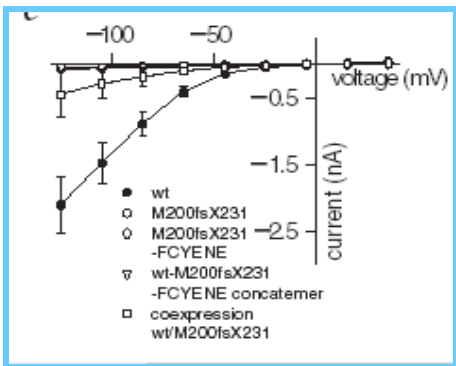
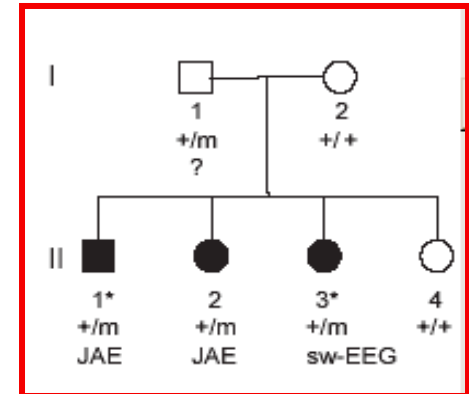
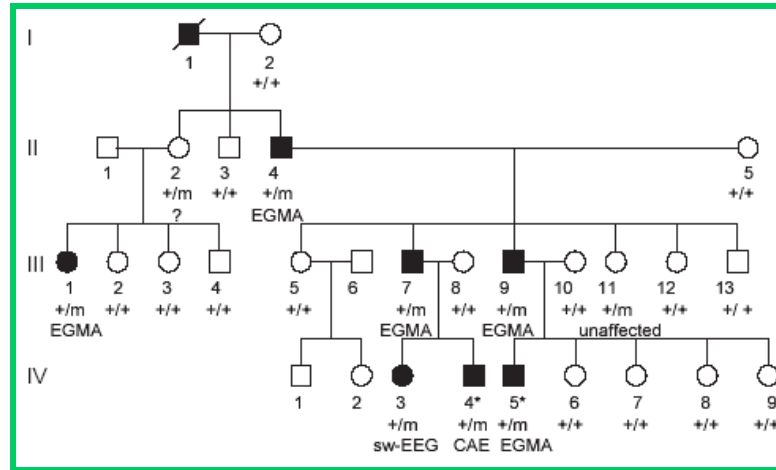
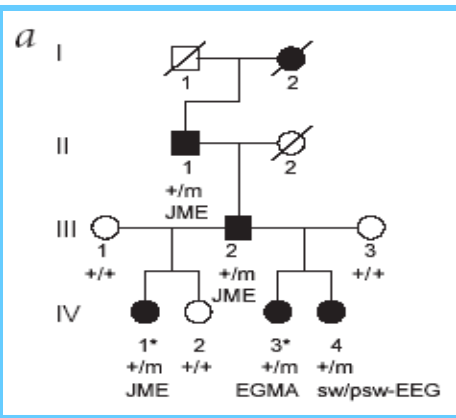

Acetylcholine Receptors

Mendelian idiopathic epilepsies

- Age of onset: 6 months - 55 years
- Partial seizures
 - Nocturnal motor seizures in clusters
 - Aura (daytime)
- Normal interictal EEG
- Ictal EEG showing generalized high-voltage slow and sharp activity followed by a fast bi-frontal rhythm.
- Absence of psychomotor delay or brain lesions

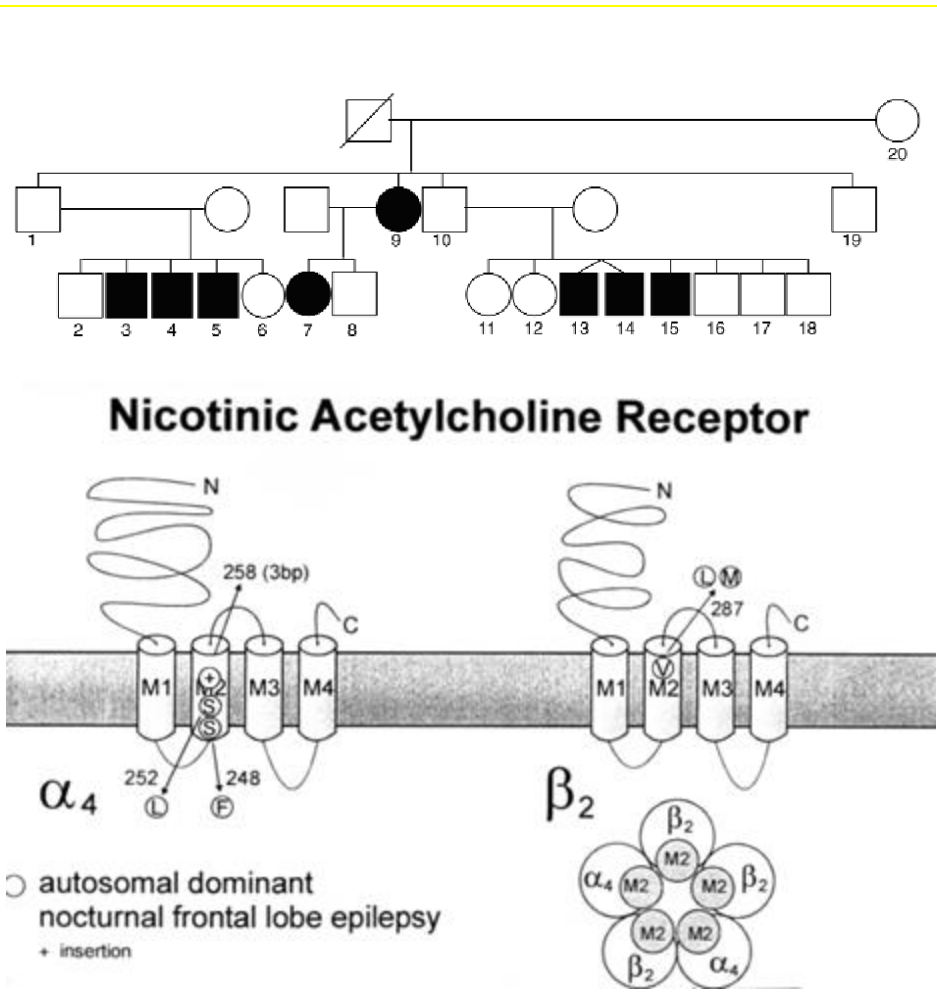

Functional analysis of Neuronal AChRs

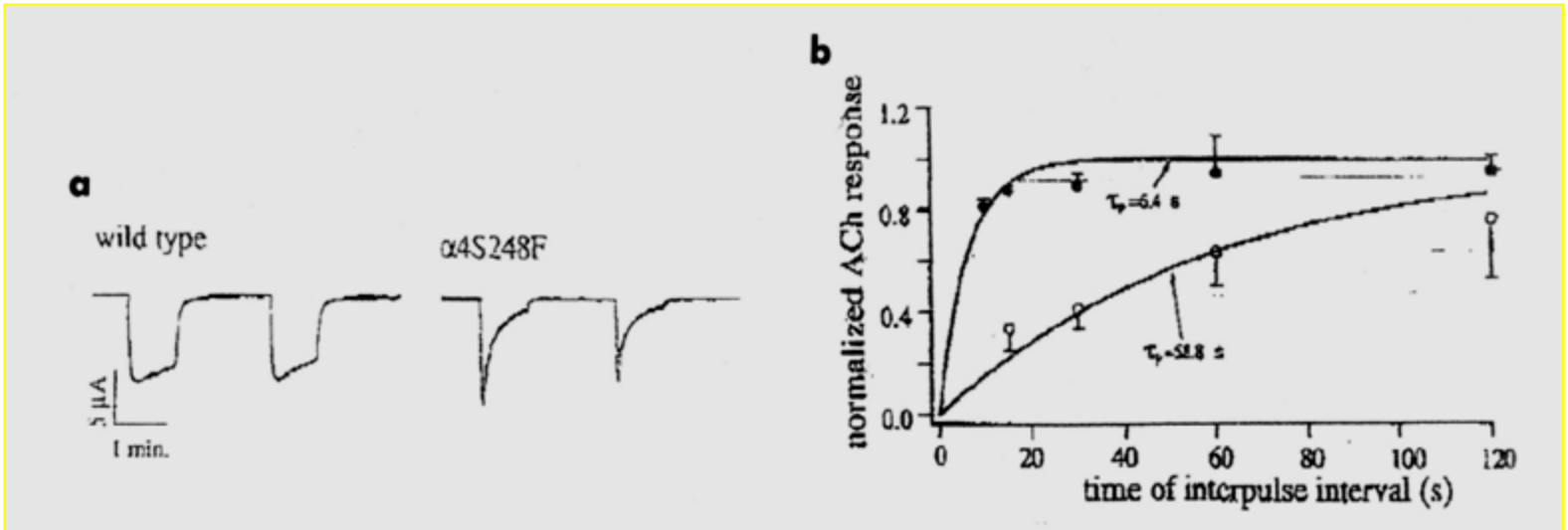
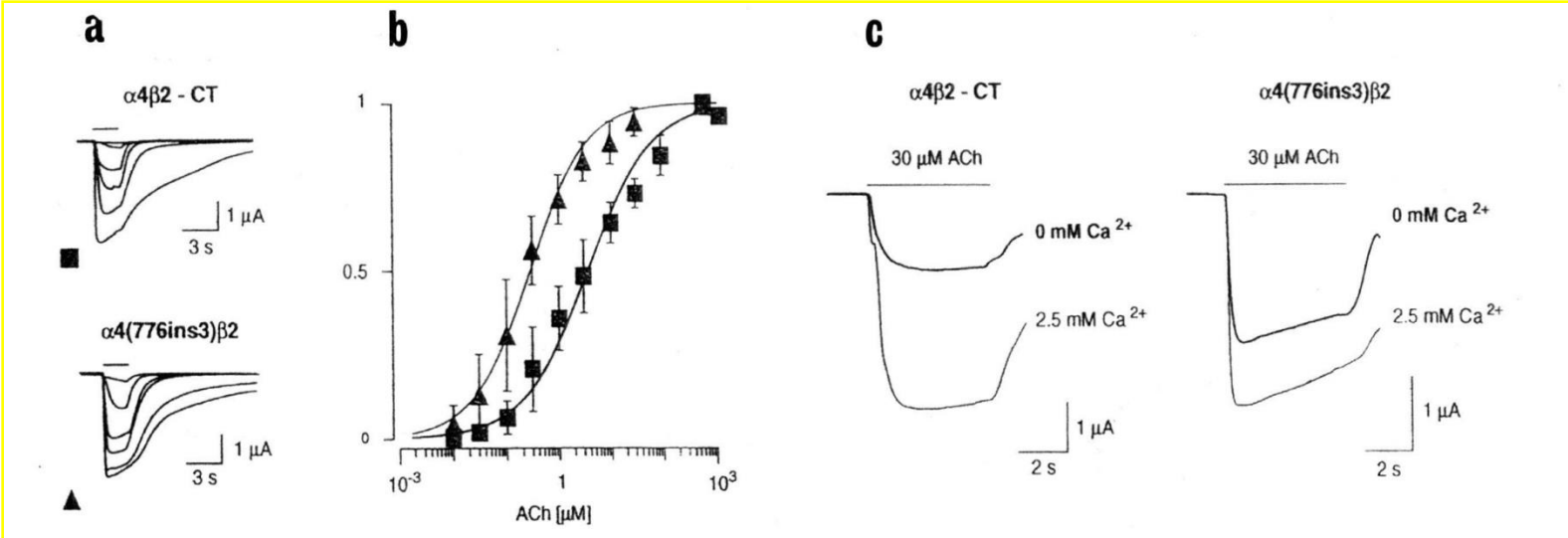

GABA_A Receptors

Mutation of *GABRA1* in an autosomal dominant form of juvenile myoclonic epilepsy

Patrick Cossette^{1,5}, Lidong Liu², Katéri Brisebois¹, Haiheng Dong³, Anne Lortie⁴, Michel Vanasse⁴, Jean-Marc Saint-Hilaire⁵, Lionel Carmant^{4,5}, Andrei Verner⁶, Wei-Yang Lu³, Yu Tian Wang² & Guy A. Rouleau¹

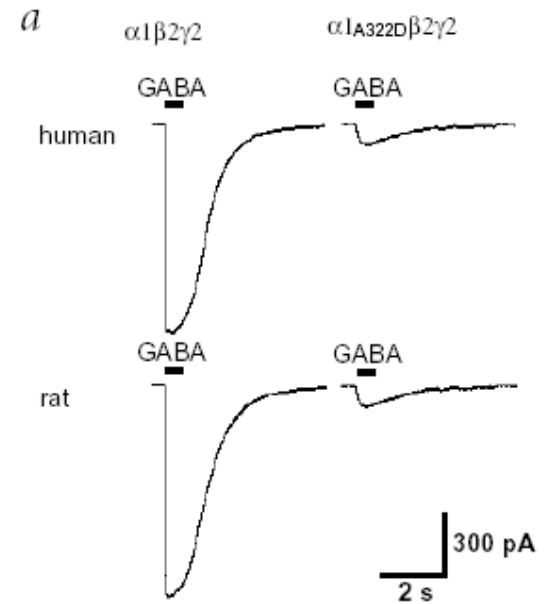
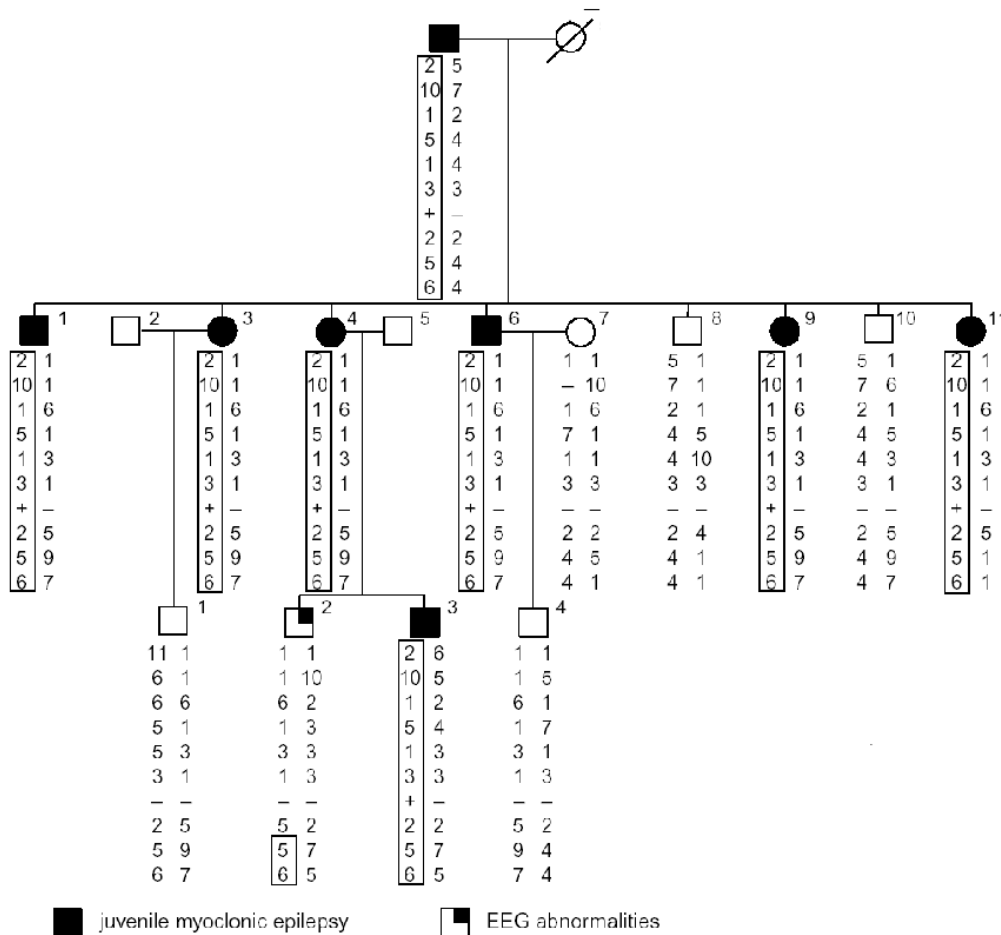

Generalized epilepsy with febrile convulsions plus

GABRG2 GABA_A receptor γ₂ subunit

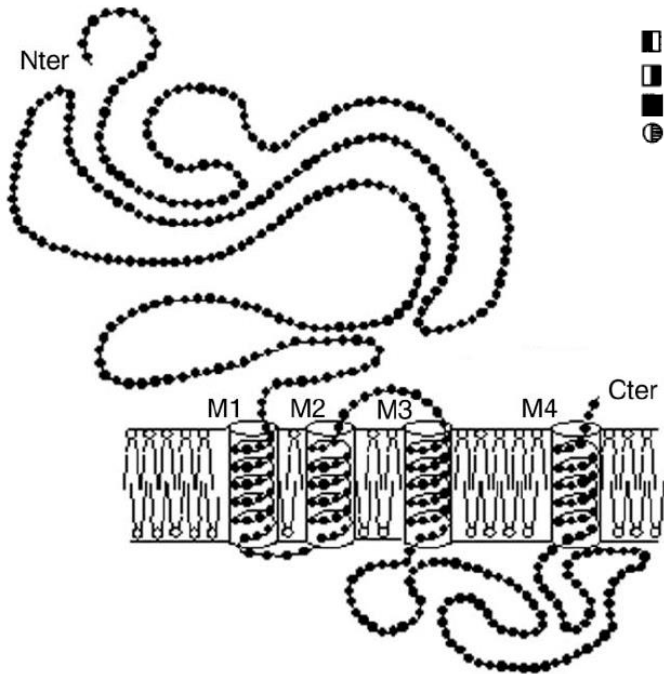
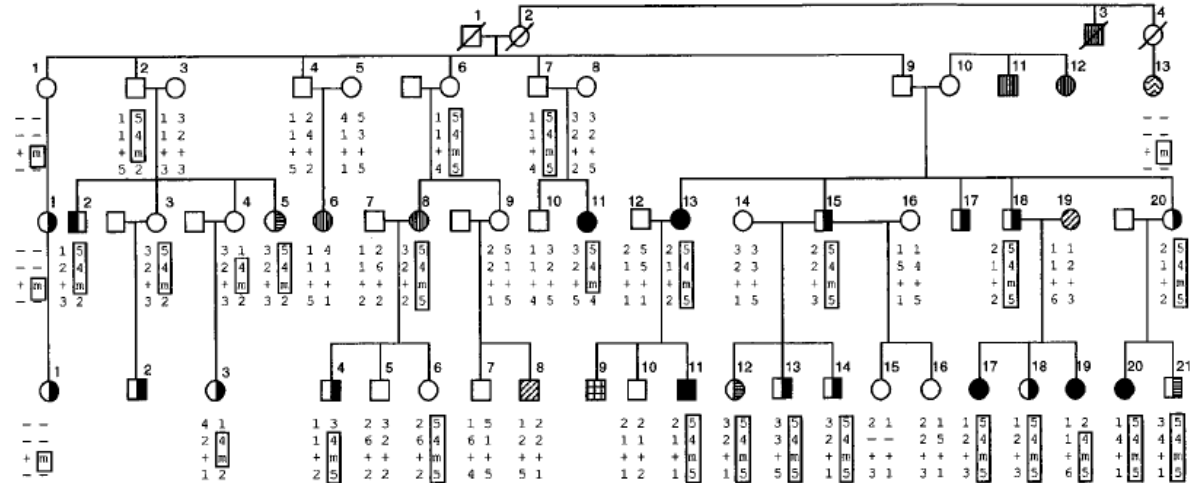

Marker	Zmax	Theta
D5S2112	2.36	0.1
D5S422	6.06	0.0
GABRG2c.245G>A	8.83	0.0
D5S2040	2.51	0.1

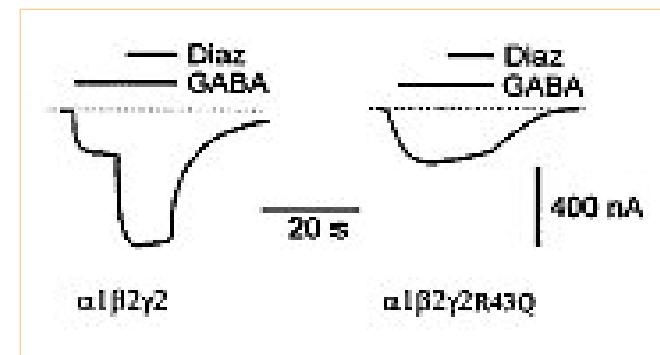
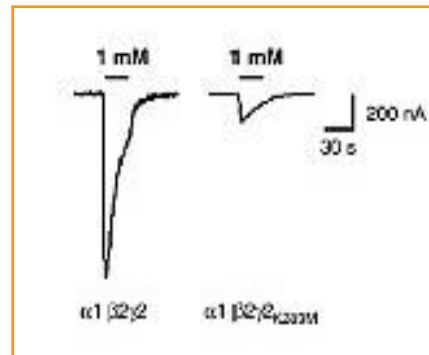

Genes involved in human idiopathic epilepsy

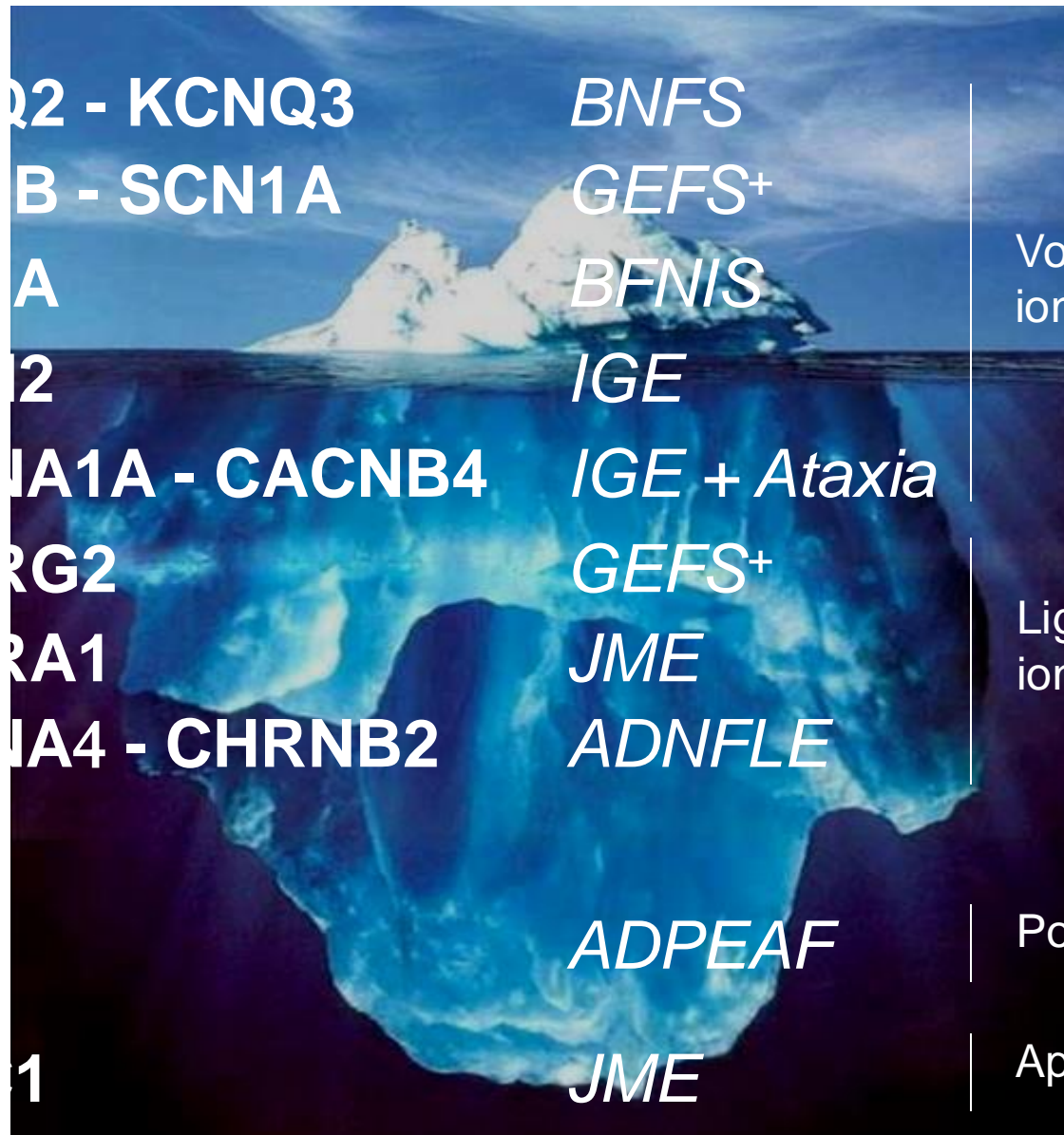

Epileptic Channelopathies

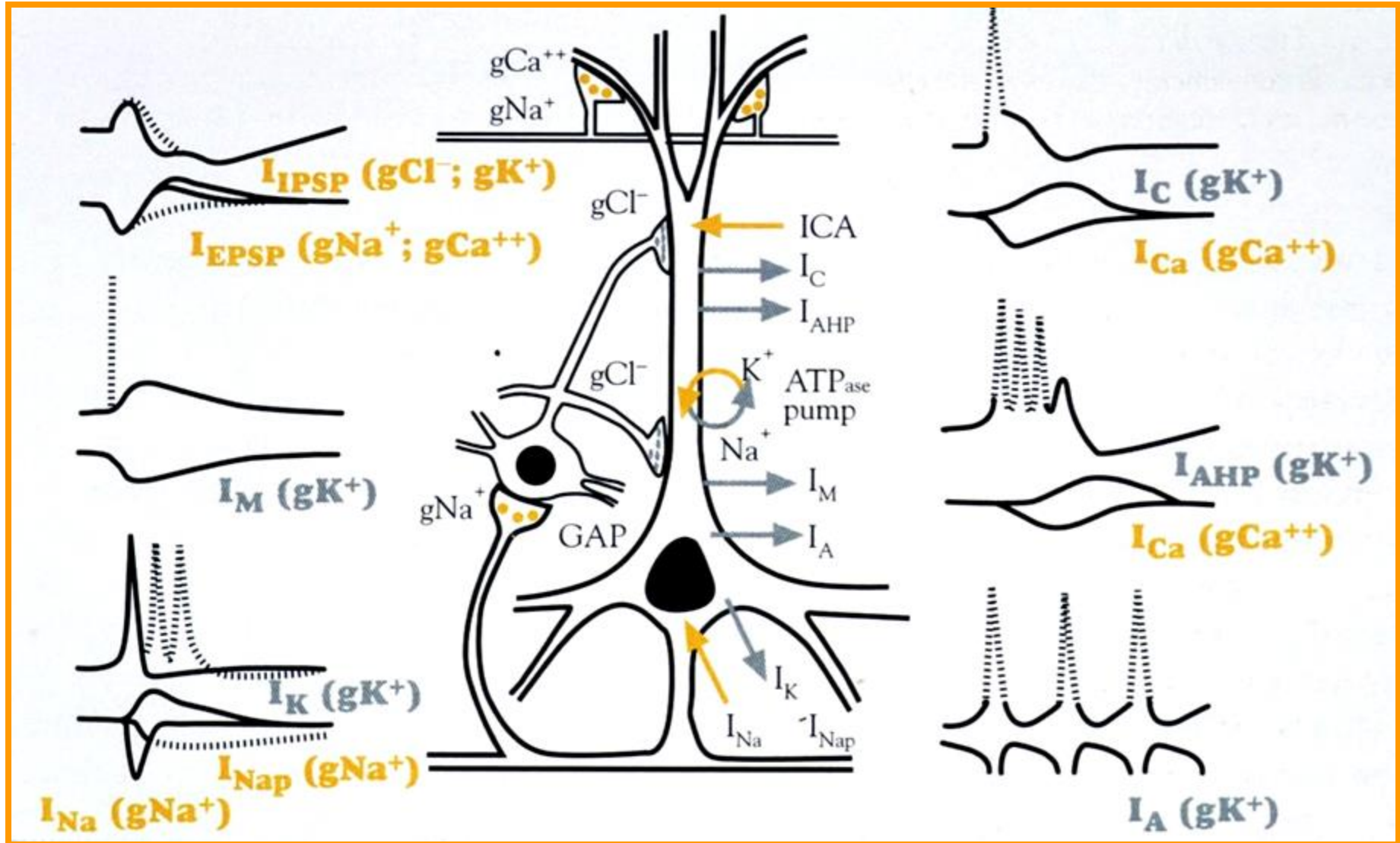

Example 4:

ATP-Sensitive K^+ Channel and
Diabetes

Discovery of K_{ATP} Channel

Nature. 1983 Sep 8-14;305(5930):147-8.

ATP-regulated K^+ channels in cardiac muscle.

Noma A.

Abstract

An outward current of unknown nature increases significantly when cardiac cells are treated with cyanide or subjected to hypoxia, and decreases on intracellular injection of ATP. We report here that application of the patch-clamp technique to CN-treated mammalian heart cells reveals specific K^+ channels which are depressed by intracellular ATP (ATPi) at levels greater than 1 mM. For these channels, conductance in the outward direction is much larger than the inward rectifier K^+ channel which is insensitive to ATP. AMP had no effect on the ATP-sensitive K^+ channel, and ADP was less effective than ATP. Thus, the ATP-sensitive K^+ channel seems to be important for regulation of cellular energy metabolism in the control of membrane excitability.

Nature. 1983 May 19-25;303(5914):250-3.

Acetylcholine activation of single muscarinic K^+ channels in isolated pacemaker cells of the mammalian heart.

Sakmann B, Noma A, Trautwein W.

Abstract

Acetylcholine (ACh) released on vagal stimulation reduces the heart rate by increasing K^+ conductance of pacemaker cells in the sinoatrial (S-A) node. Fluctuation analysis of ACh-act currents in pacemaker tissue showed this to be due to opening of a separate class of K^+ channels.

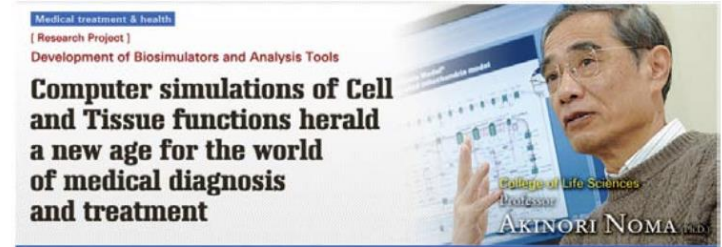

Saalland大学三人組と三内三人組

ATP-Sensitive Potassium Channel

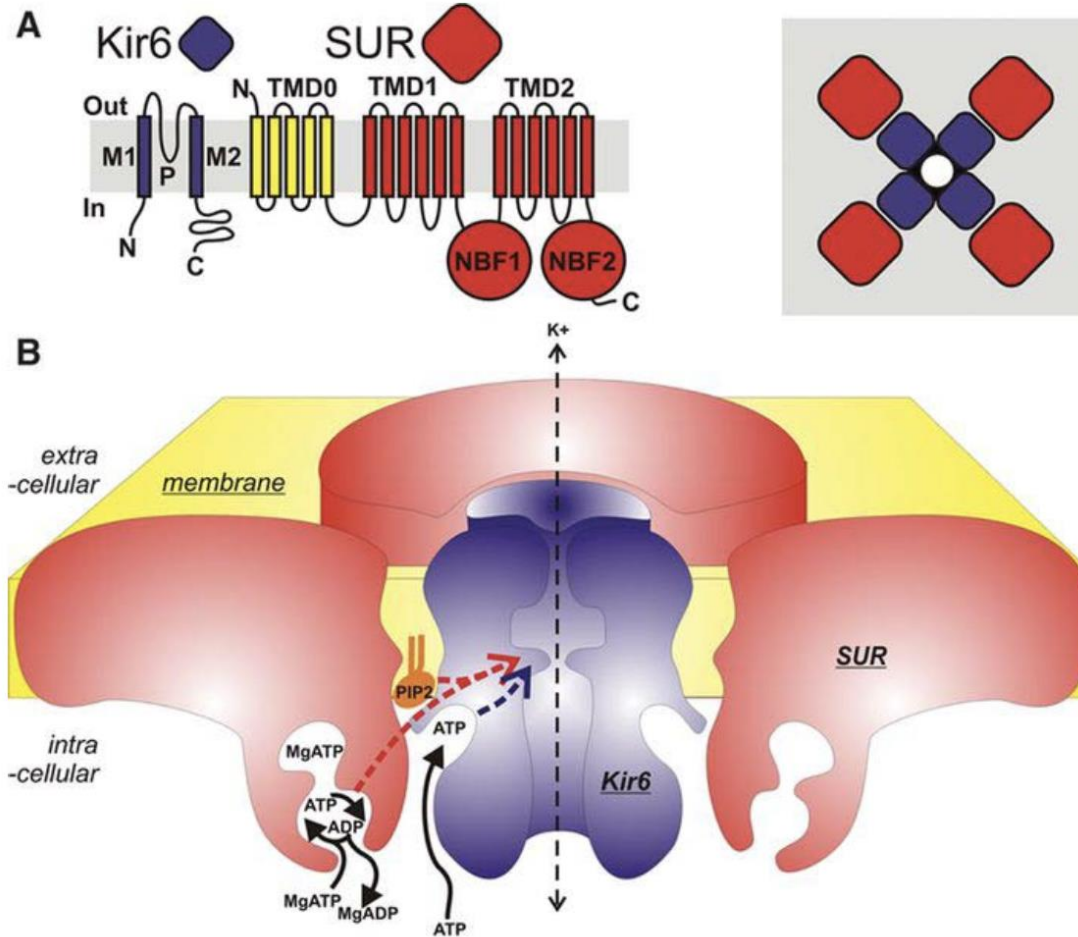

Is composed of Kir6.x and sulfonylurea receptors (SURs)

- Inhibited by ATP
- Inhibited by sulfonylurea via SURs

ATP-Sensitive K channel Inhibited by ATP

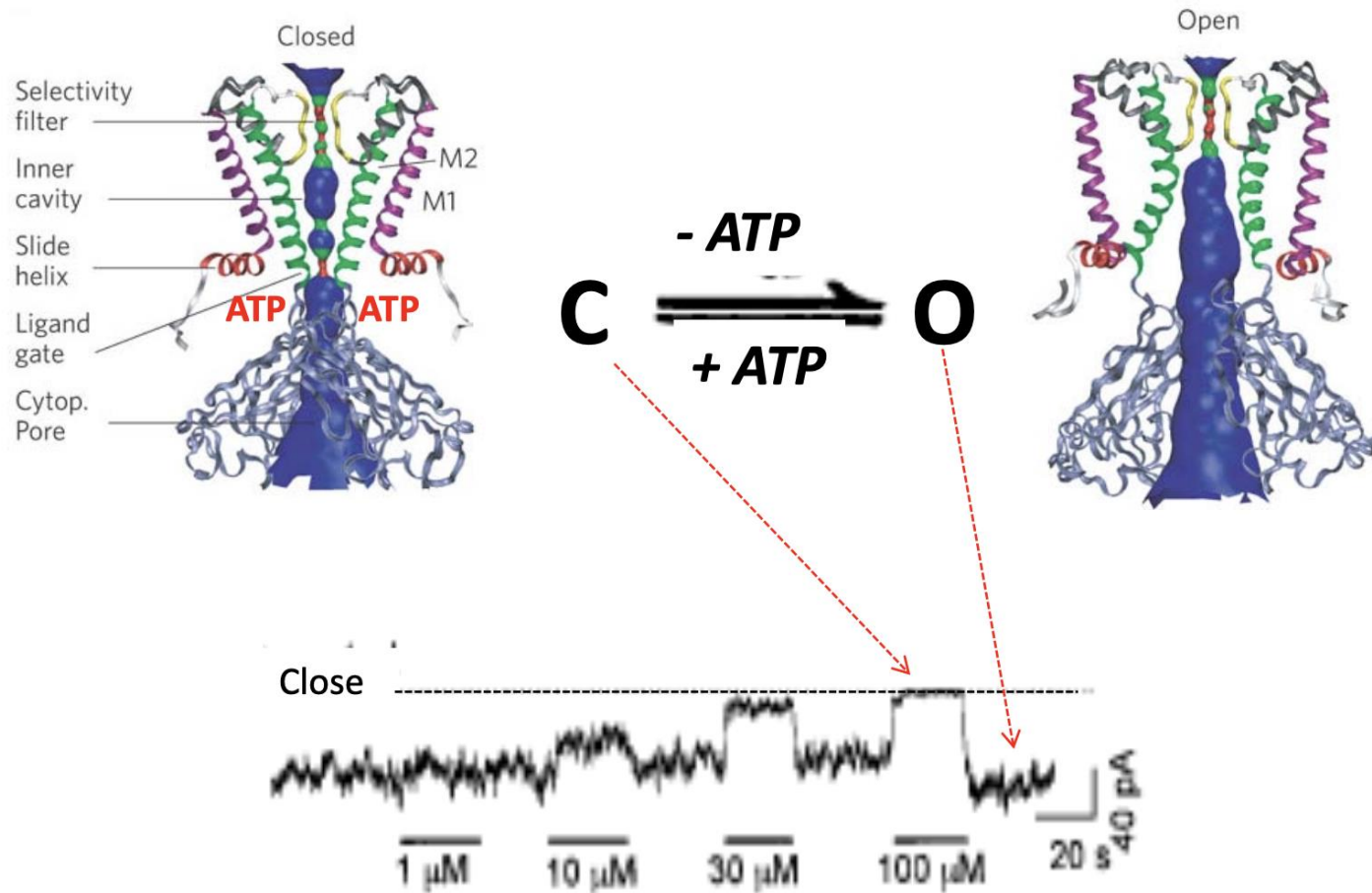

Role of the K_{ATP} Channel in Insulin Secretion in Pancreatic β Cell

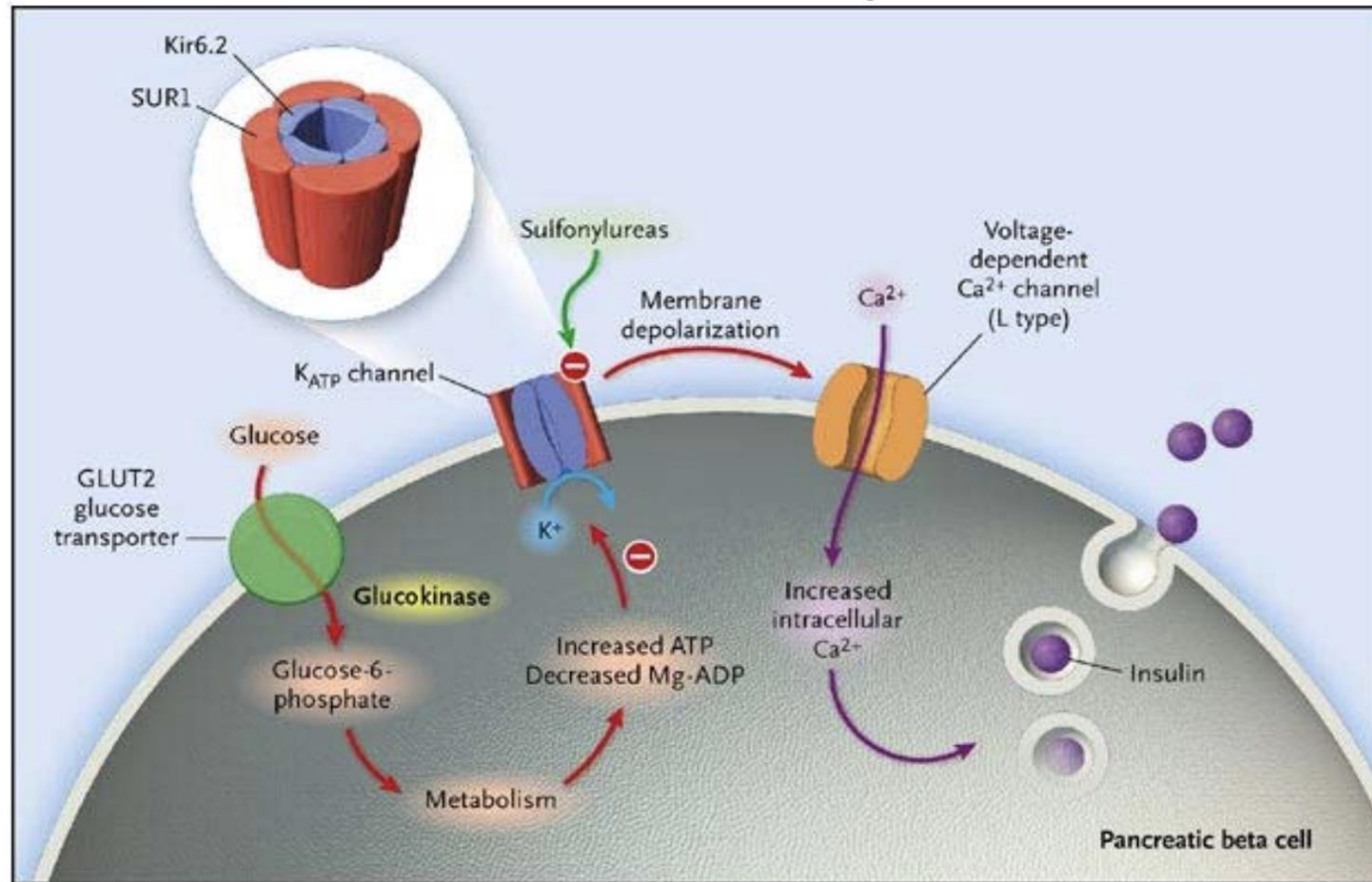

- Glucose enters the cell via the GLUT2 transporter
- Glycolytic and mitochondrial metabolism leads to an **increase in ATP**
- This results in **K_{ATP} channel closure**, membrane **depolarization**,
- Opening of voltage-gated **Ca^{2+} channels**, Ca^{2+} influx,
- Exocytosis of **insulin** granules (insulin secretion).

K_{ATP} Channel Mutations Causing Lower ATP Sensitivity and Diabetes

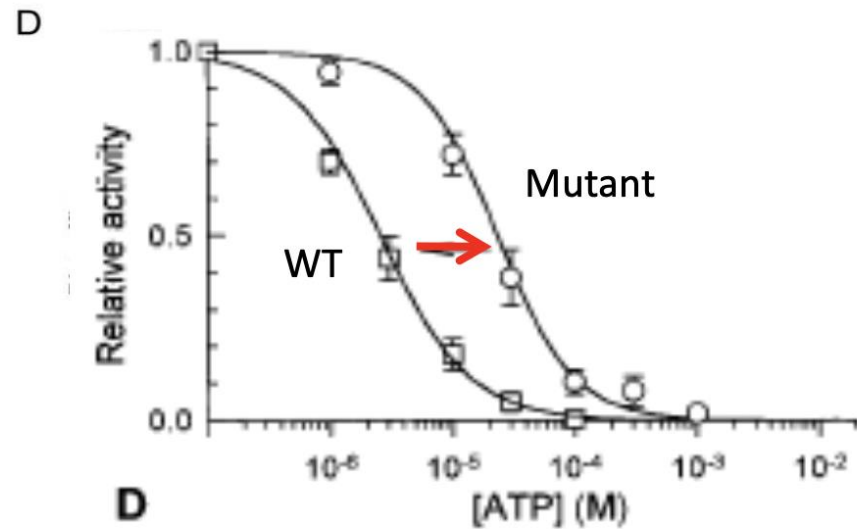
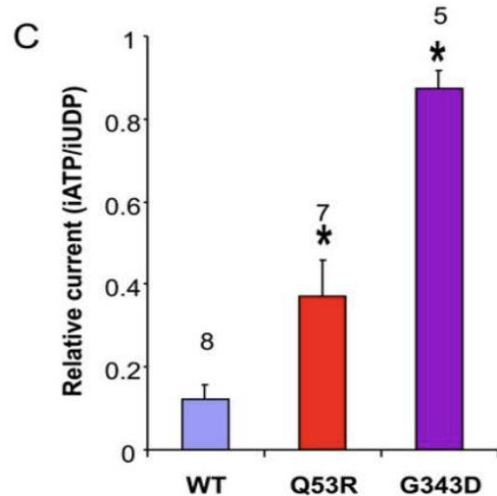
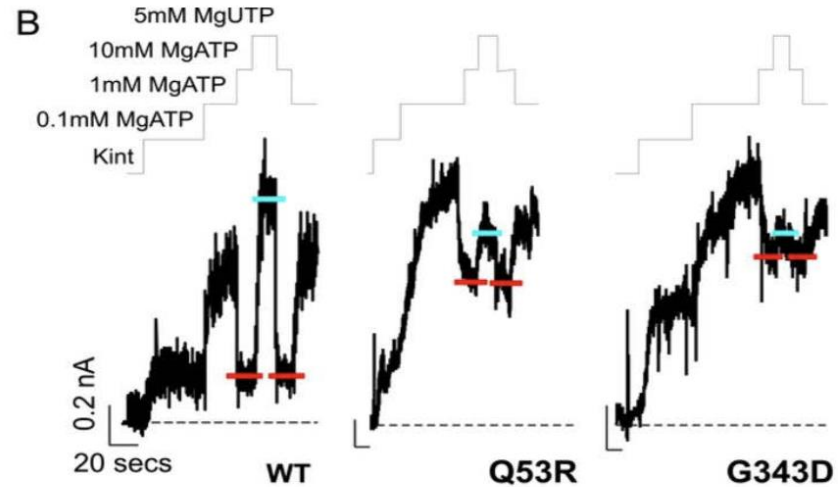
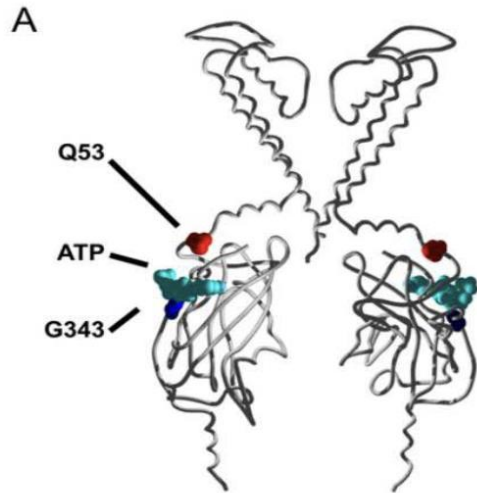

The K_{ATP} Channel Couples Glucose Metabolism to Insulin Secretion

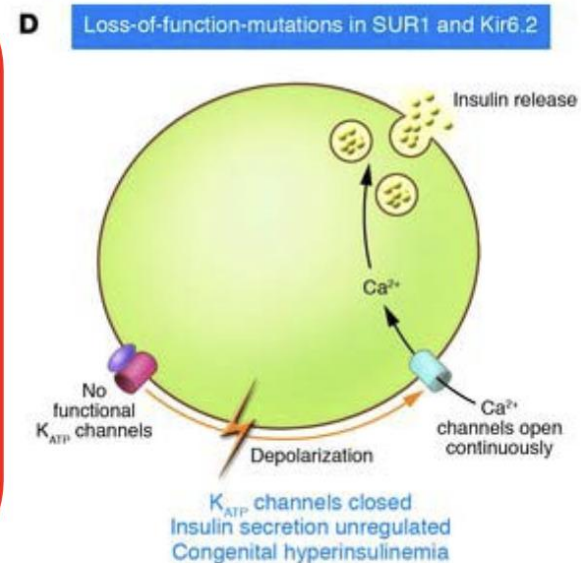
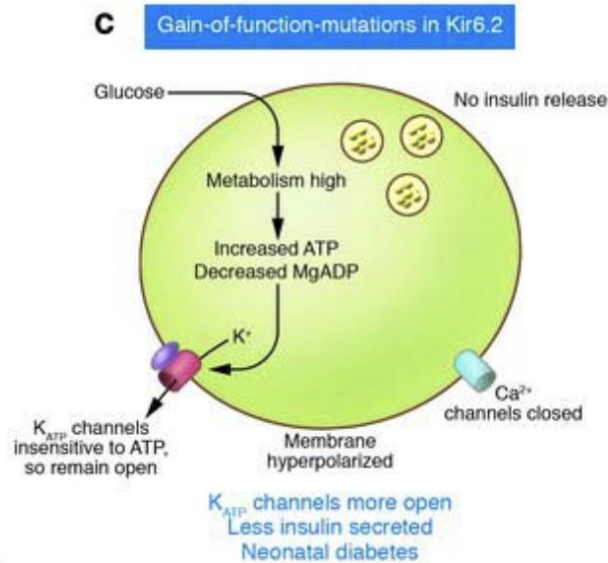
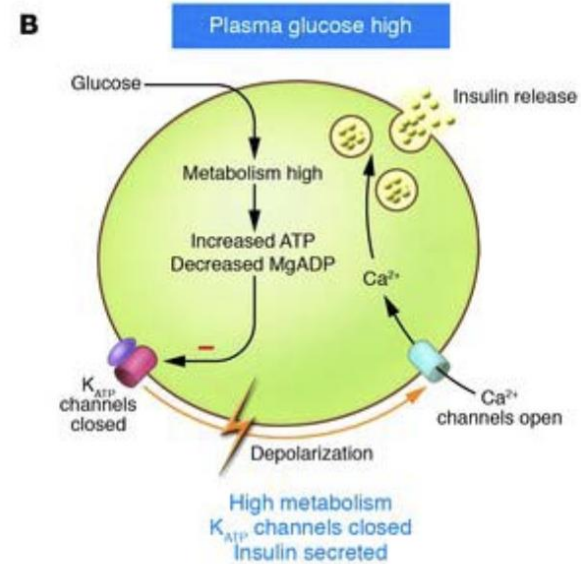
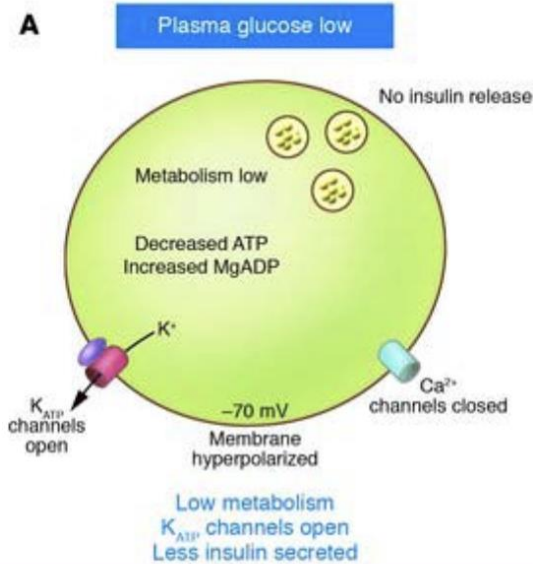

Example 5:

Cystic Fibrosis: Cl⁻ Channel Disease

Cystic Fibrosis: Facts

- Cystic fibrosis (CF) is autosomal recessive disease
- CF is a chronic, progressive, life threatening genetic disorder of pediatrics.
- It affect white population (1 in 3200 live births) but is uncommon among Asian and African population
- It affects exocrine glands (mainly sweat glands) and mucus gland present on the epithelial lining of lungs, pancreas, intestine, and reproductive system.
- CF is a defect in epithelial chloride channel protein, causes membrane to become impermeable to Chloride ion.

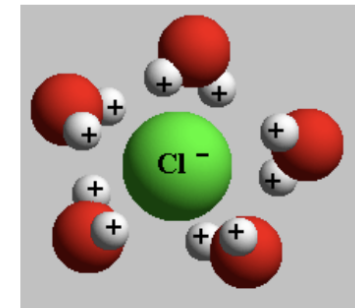
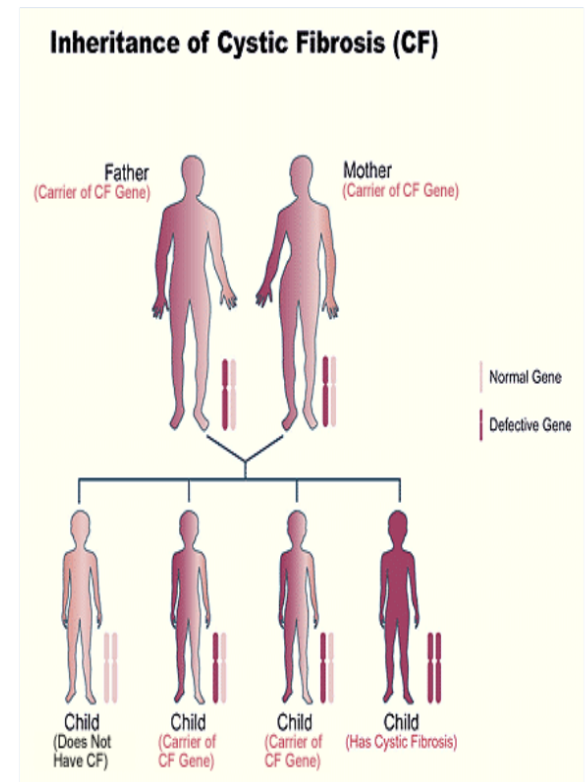

CFTR gene encode for the CFTR protein channel

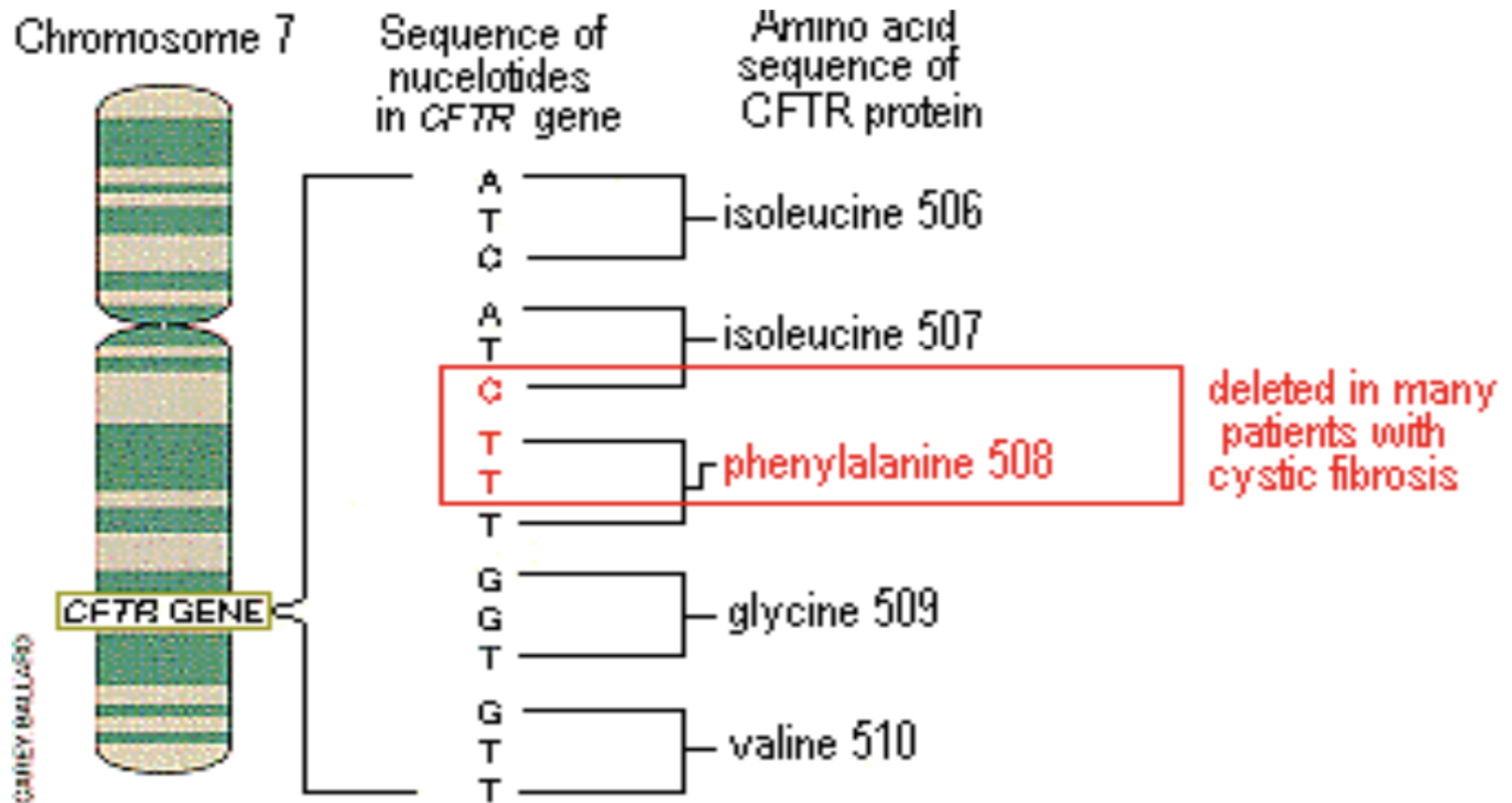

CF occurs due to the deletion of 3 nucleotides which code for the phenylalanine from the CFTR (cystic fibrosis transmembrane conductance regulator) gene located on chromosome no.7 at position 508. This mutation is known as ΔF 508

Structure of the CFTR protein

CFTR protein is a cAMP induced Channel made up of five domains:
Two membrane-spanning domain (MSD1 & MSD2) that form Cl⁻ ion channel.

Two nucleotide binding domains (NBD1 & NBD2) that bind and hydrolyze ATP.

A regulatory R domain.

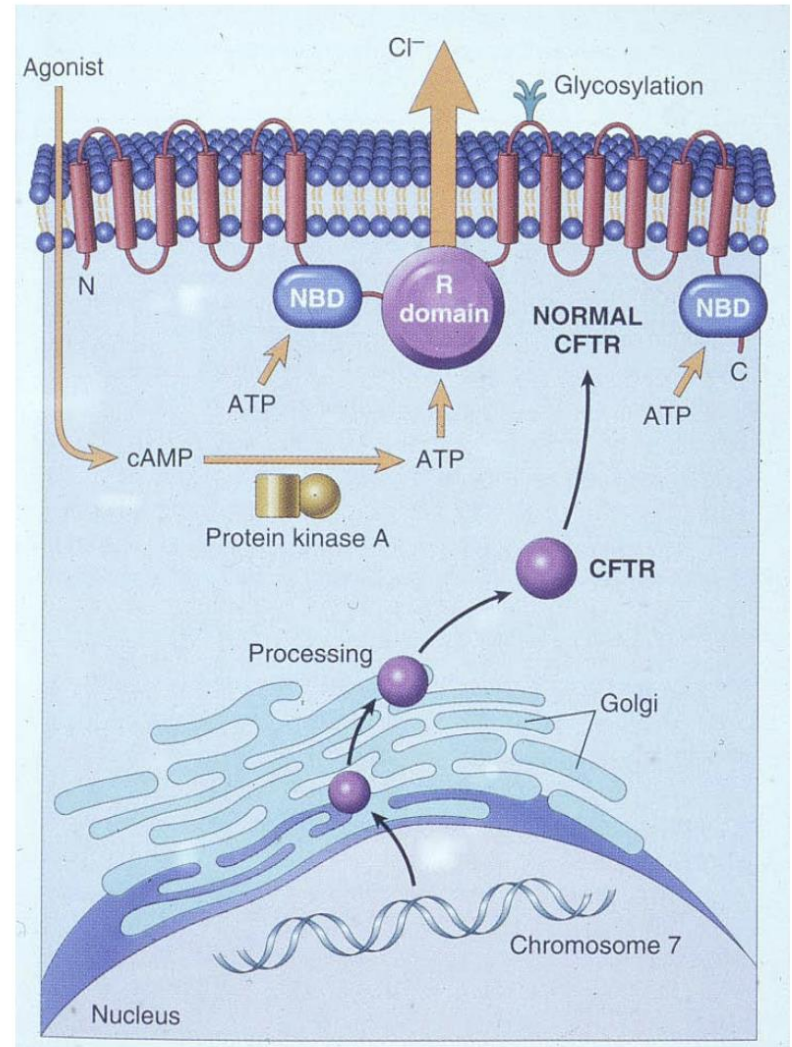

CFTR mutation: Loss of Cl⁻ Channel Function

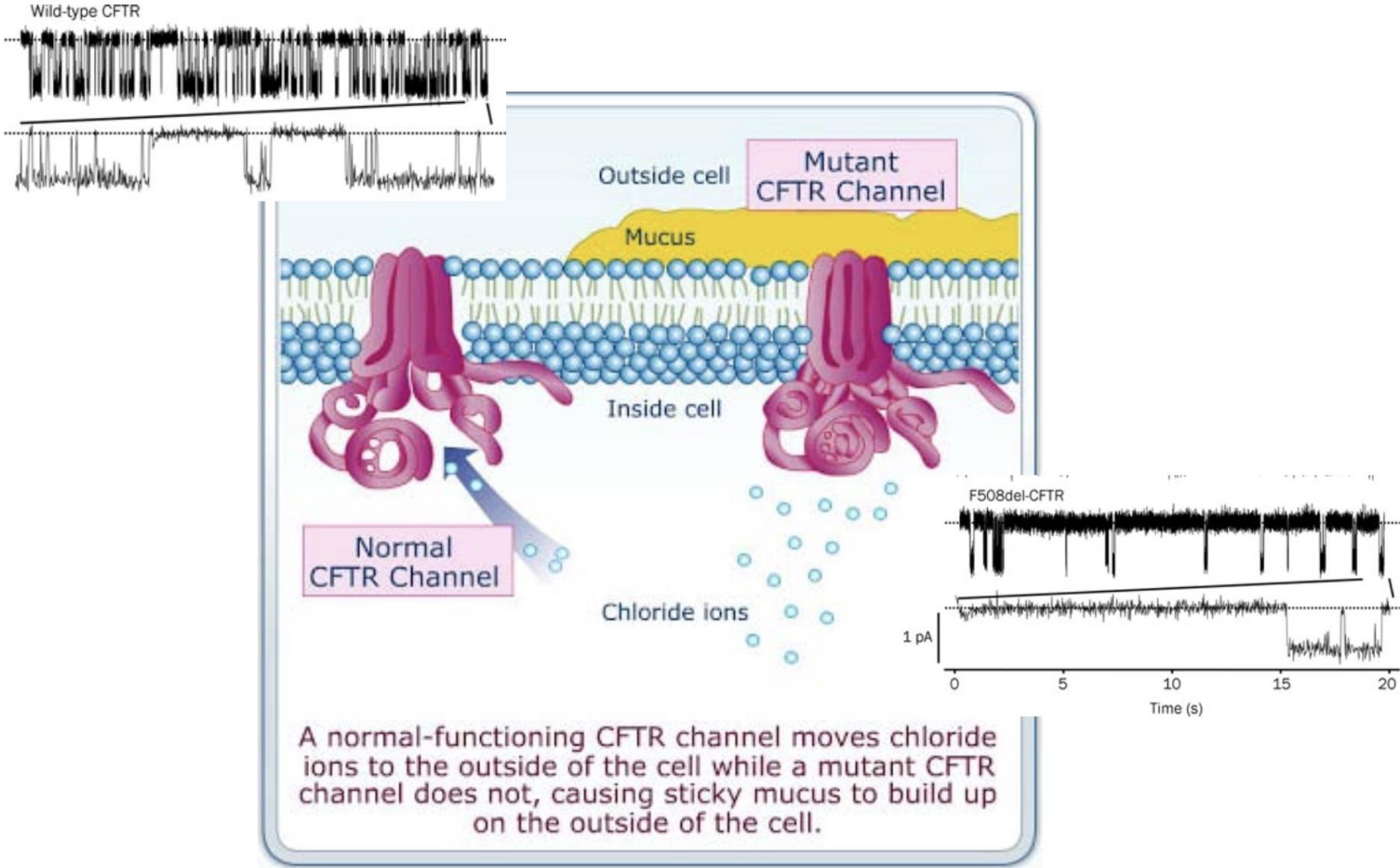

Pathology of Cystic Fibrosis - 1

In **sweat glands**:

CFTR is responsible for re-absorption of Cl^- along with Na^+ through epithelial Na channel (ENaC).

Impaired function of CFTR cause the production of hypertonic salty sweat, and ultimately dehydration.

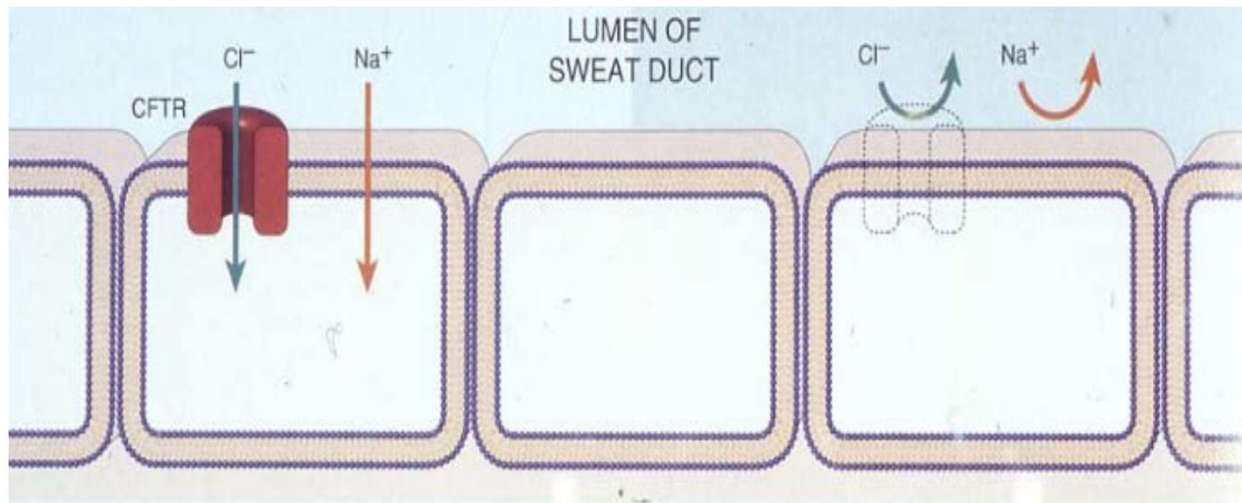

SWEAT GLANDS

Pathology of Cystic Fibrosis - 2

In lung **mucus glands**:

- Loss of CFTR function to secrete chloride ion →
- Loss or reduction of Cl^- ion in luminal secretion →
- Followed by active luminal Na^+ absorption through ENaC →
- Increases passive water absorption from the lumen →
- Impaired mucociliary action, accumulation of thick, viscous, dehydrated mucus
- Obstruction of air passage and recurrent pulmonary infections

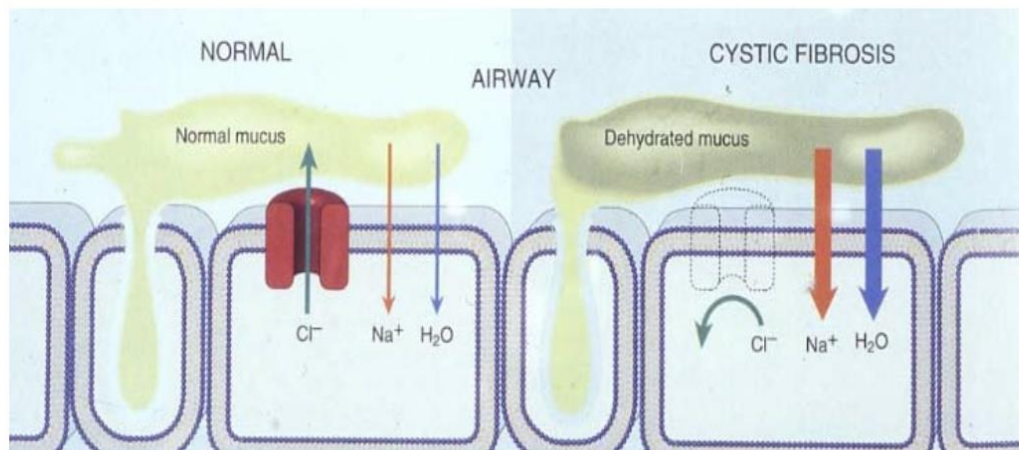

Example 6:

**Skeletal Muscle
Channelopathies**

Post-synaptic myasthenia syndromes

Characteristics of the disease:

myasthenic symptoms:

**hyposthenia and muscular exhaustion of the skeletal and bulbous innervation muscles,
without involvement of the immune system (absence of autoantibodies)**

prevalence less than 1: 500 000

early onset, usually immediately after birth.

There are several forms whose clinic depends on which molecule of the neuromuscular junction (NMJ) is genetically altered: they can be pre-synaptic, synaptic or post-synaptic.

slow-channel syndrome

fast-channel syndrome

Acetylcholine receptor deficiency (AChR).

May arise during childhood (severe form) or later, up to the 7th decade (lighter form)

The extensor muscles of the forearm, the musculature of the neck and that of the scapula are selectively affected.

Ionic Channels

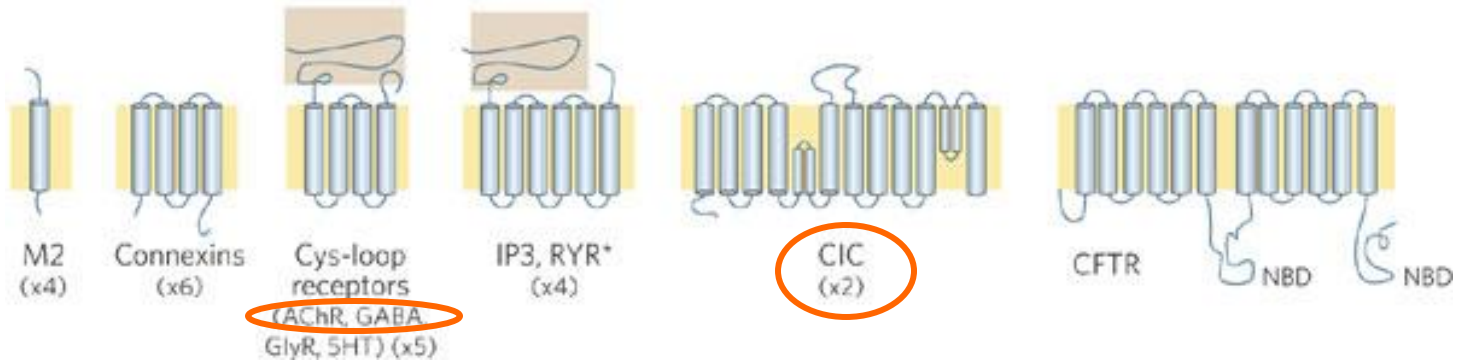
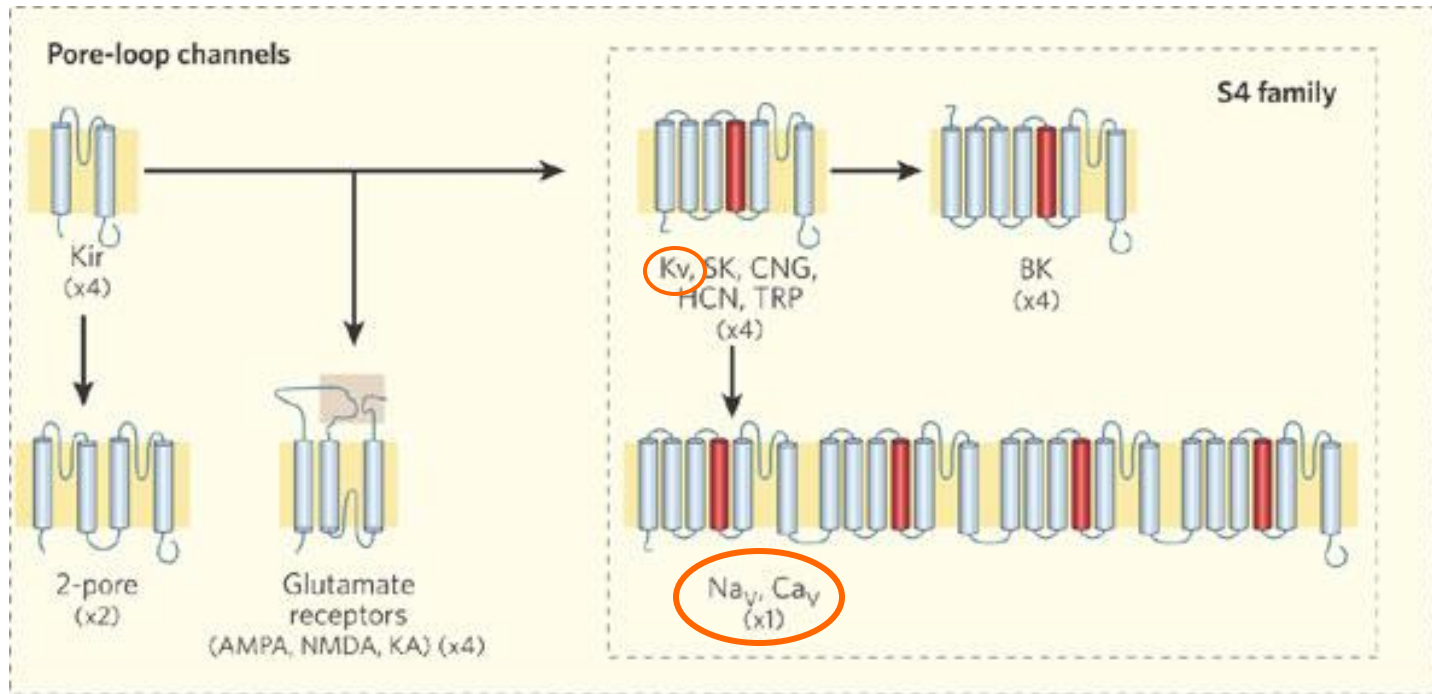

Neuromuscular junction and the propagation of excitation in skeletal muscle

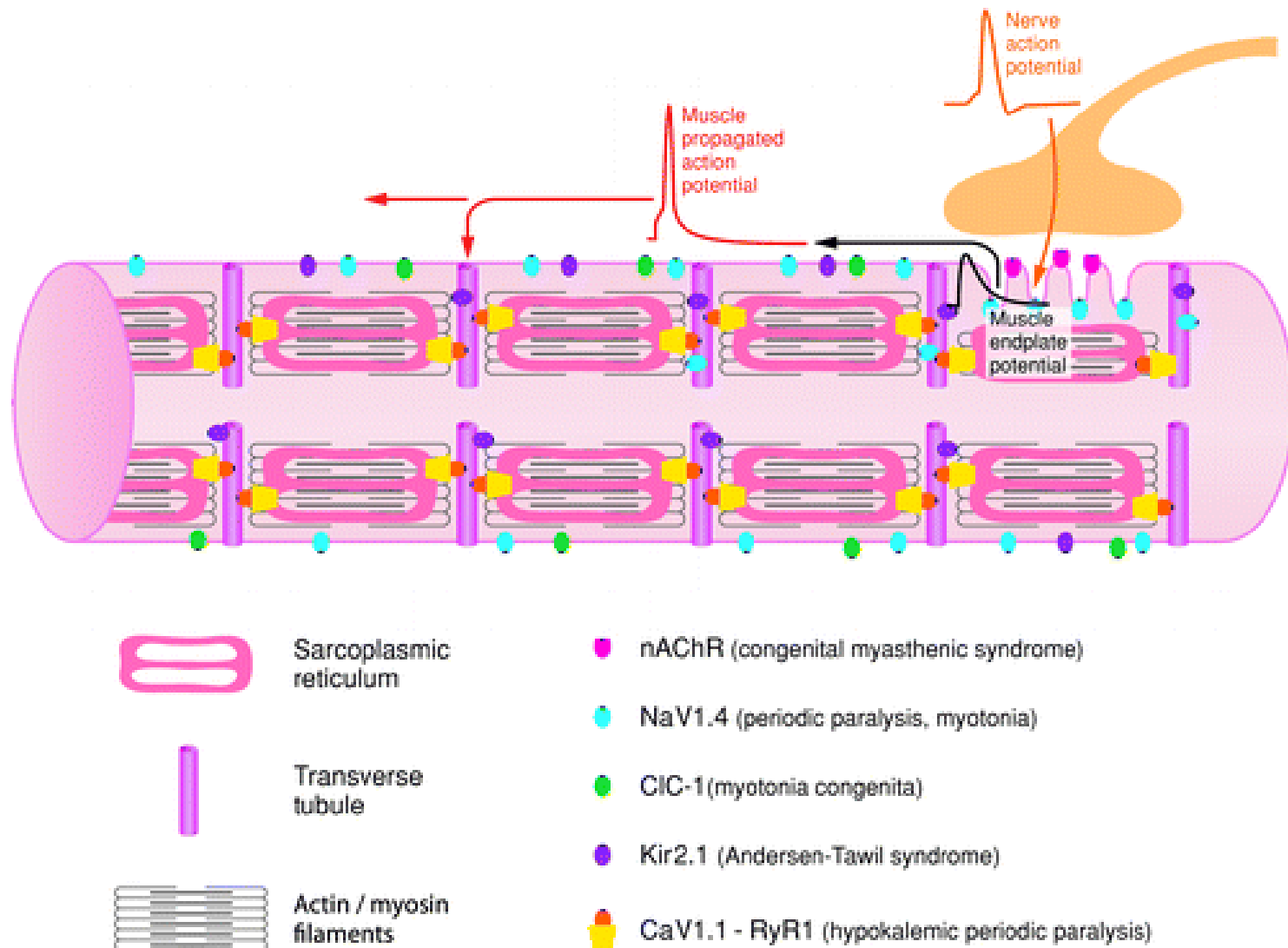

Common features:

- **Symptoms often manifest as transient attacks separated by long periods of normal function**
- **Mostly autosomal dominant mutations**
- **Clinical phenotype generally limited to the involvement of a single organ**

Skeletal Muscle Channelopathies

- 1) Defects in neuromuscular transmission
- 2) Defects in the Sarcolemma excitability

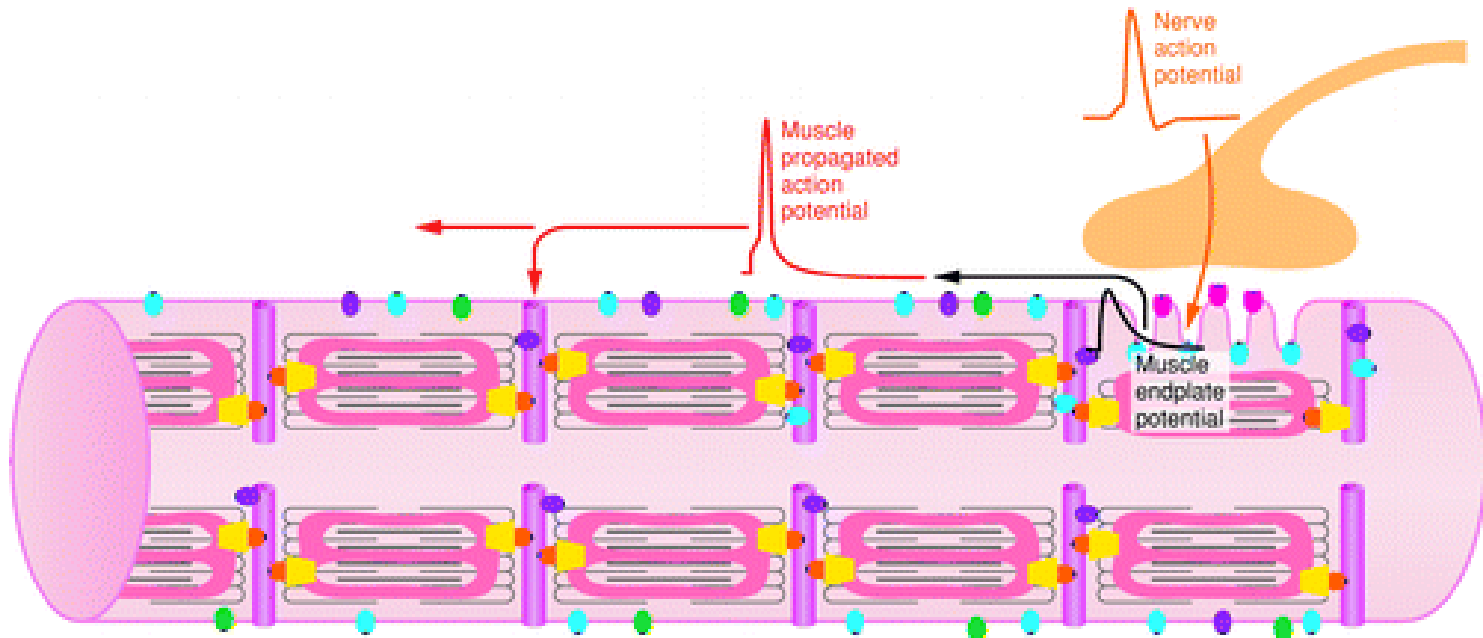

Defects in neuromuscular transmission



Congenital Myasthenic Syndromes (CMS):

- hereditary diseases in which neuromuscular transmission is damaged by one or more specific mechanisms: the Endplate Potential is insufficient to activate the NaV channels responsible for the propagation of the action potential.
- They occur at birth or early adolescence
- They involve the muscles of the eyes, the skull and the limbs

Neuromuscular Junction

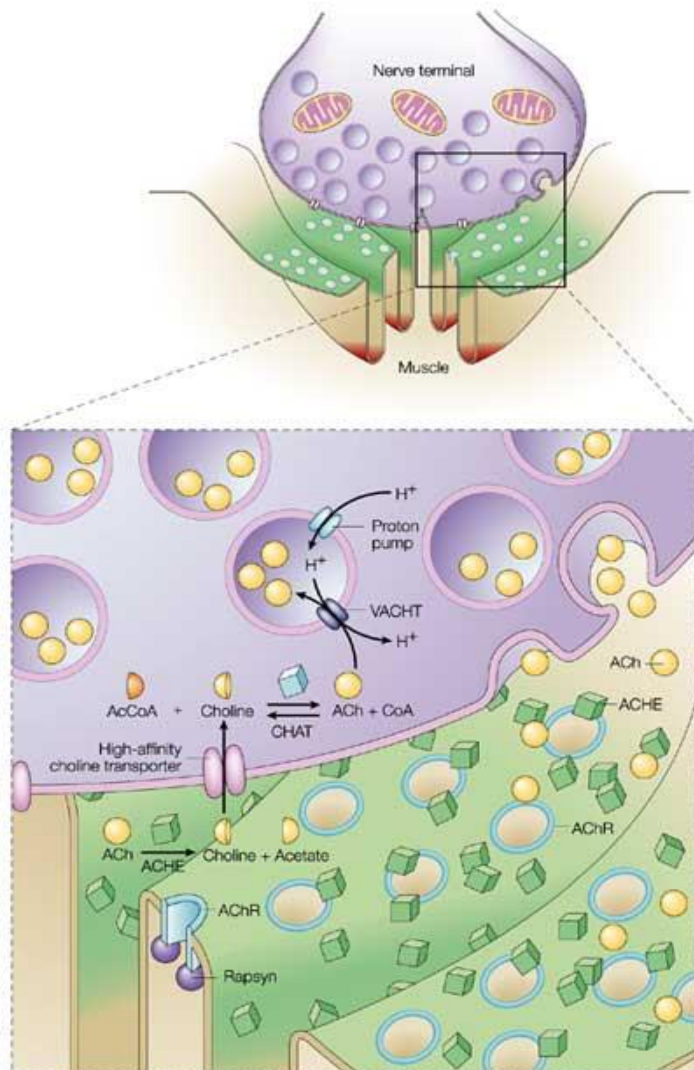
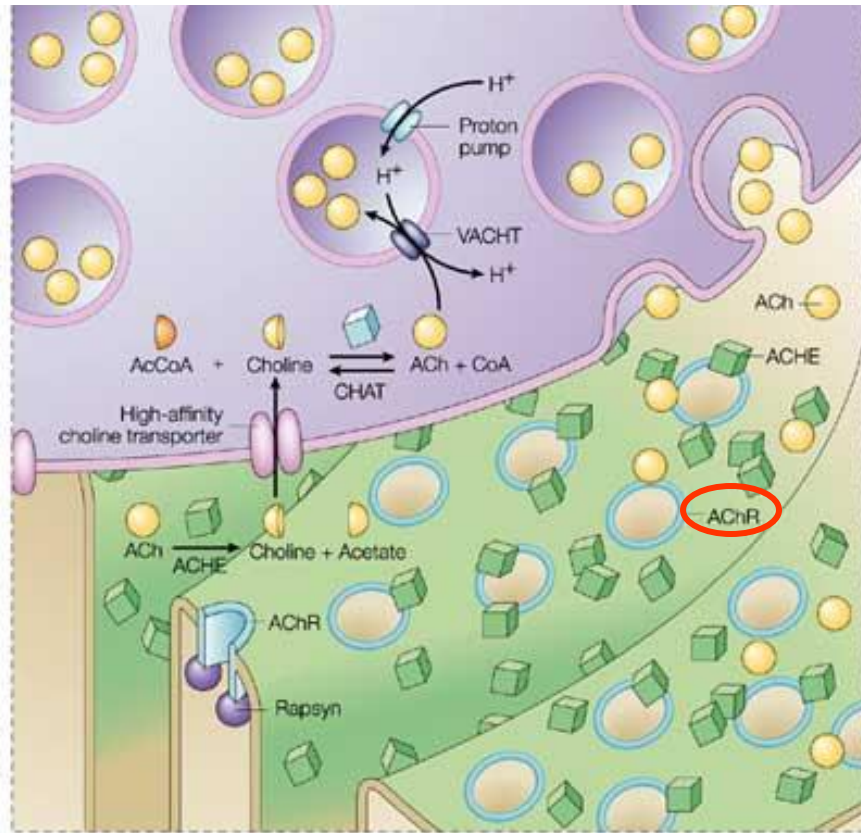

Table 1 | **Classification of CMSs**

Site of defect	Index cases
Presynaptic defects (7%)	
CHAT deficiency [†]	6
Paucity of synaptic vesicles and reduced quantal release	1
Lambert-Eaton syndrome like	1
Other presynaptic defects	4
Synaptic basal lamina-associated defects (14%)	
Endplate ACHE deficiency [†]	26
Postsynaptic defects (79%)	
Kinetic abnormality of AChR with/without AChR deficiency [†]	45
AChR deficiency with/without minor kinetic abnormality [†]	83
RAPSYN deficiency [†]	17
Plectin deficiency	1
Total (100%)	185

*Classification based on cohort of congenital myasthenic syndrome patients investigated at the Mayo Clinic between 1988 and 2003. [†]Gene defects identified. ACHE, acetylcholinesterase; AChR, acetylcholine receptor; CHAT, choline acetyltransferase; CMSs, congenital myasthenic syndromes.

CMS caused by defects in the Acetylcholine Receptor (AChR):



Nature Reviews | Neuroscience

Mutations in different domains
of the different subunits:
Reduced receptor
expression

Altered kinetic properties
("Slow & Fast Channel
CMS")

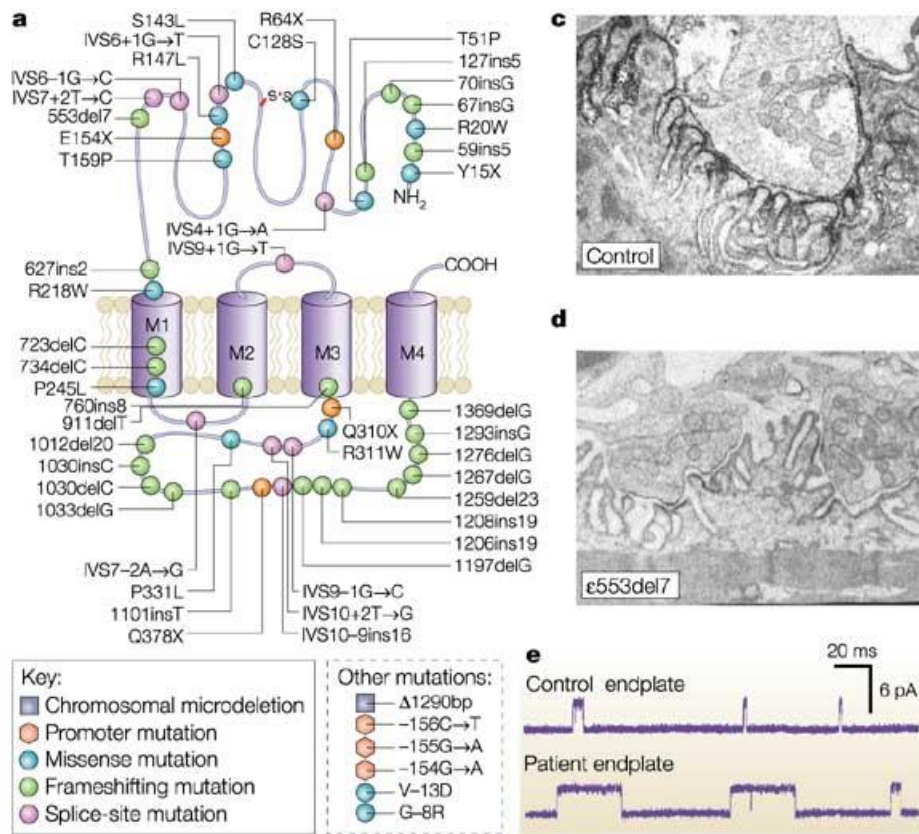

nAChR is a ligand-activated post-synaptic membrane receptor heteropentamer: 2 sub α , β , δ , ϵ (γ)

The part that protrudes in the junction has 2 binding domains for the Ach at the interface between the subunits

The transmembrane part forms the channel

The cytoplasmic extension contains structures that modulate the opening of the canal and anchor the cytoplasmic protein receptor

Mutations affect the maturation and expression in the receptor membrane

CMS caused by defects in the **Rapsin** protein:

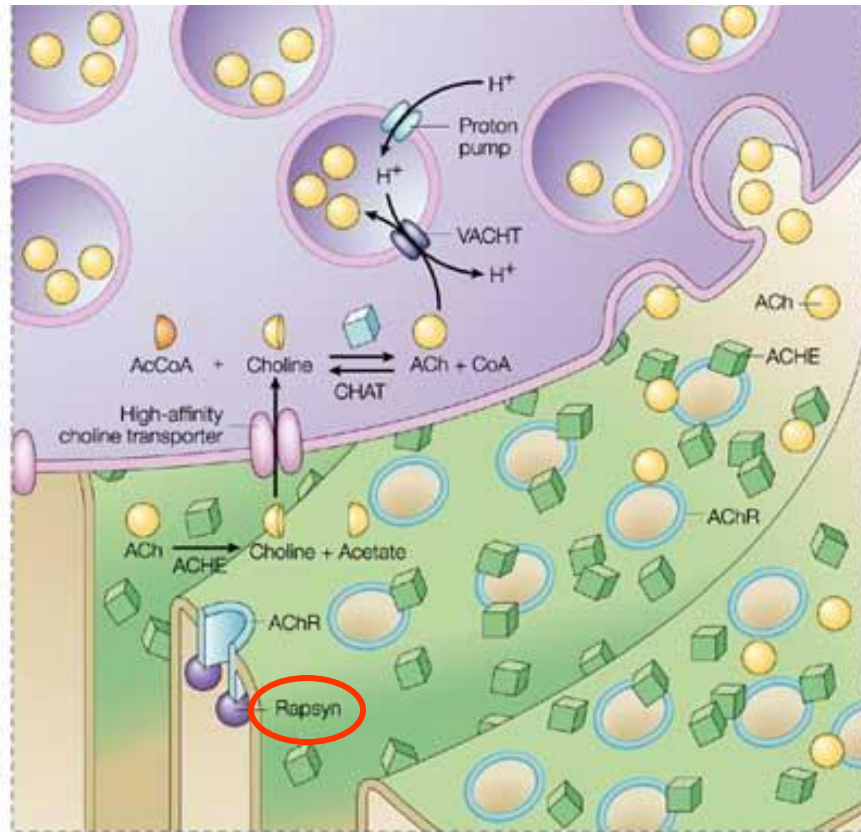

Nature Reviews | Neuroscience

Rapsin, together with other proteins such as Agrin and MUSK, regulates the membrane expression of AChR

It associates with itself and binds the cytoplasmic domains of AChR subunits

By binding to β -dystroglycan, it binds the receptor to the post-synapse cytoskeleton

Mutations in Rapsin protein domains

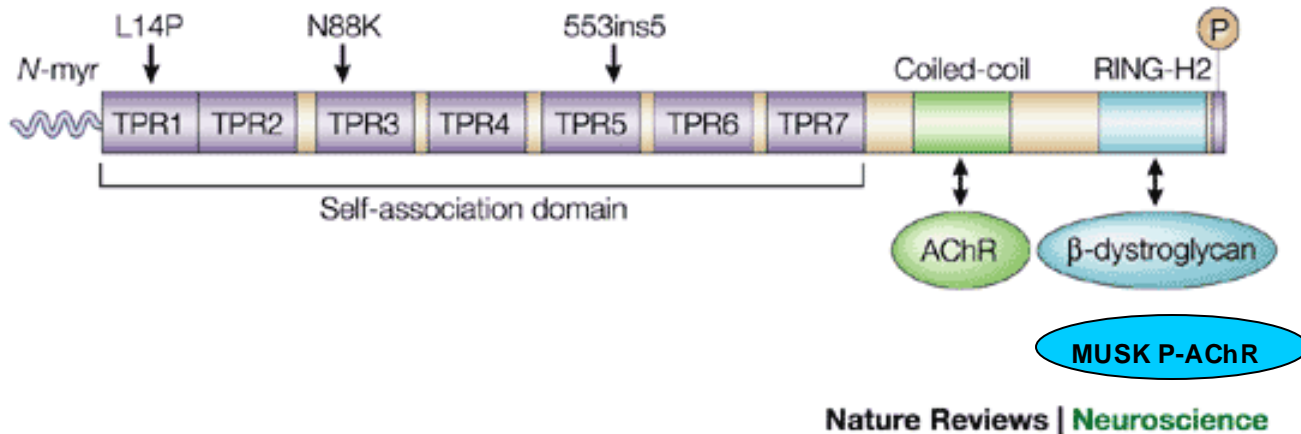

Mutations compromise co-carriage of the AChR receptor with Rapsin

Post-synaptic regions are poorly developed

CMS caused by defects in Choline-acetyltransferase (CHAT):

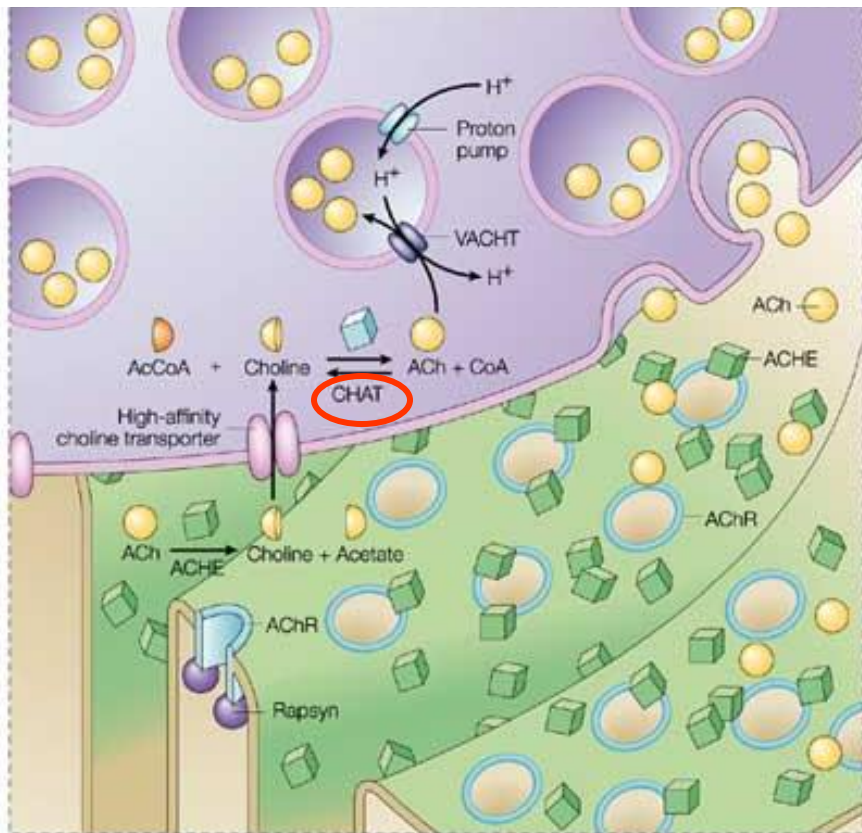

Nature Reviews | Neuroscience

It manifests at birth or during childhood or early adolescence

Respiratory problems and / or episodic apnea attacks

The concentration of AChR and the structure of the post-synapse is normal, but the synaptic vesicles are smaller than normal both in the resting muscle and after stimulation

a

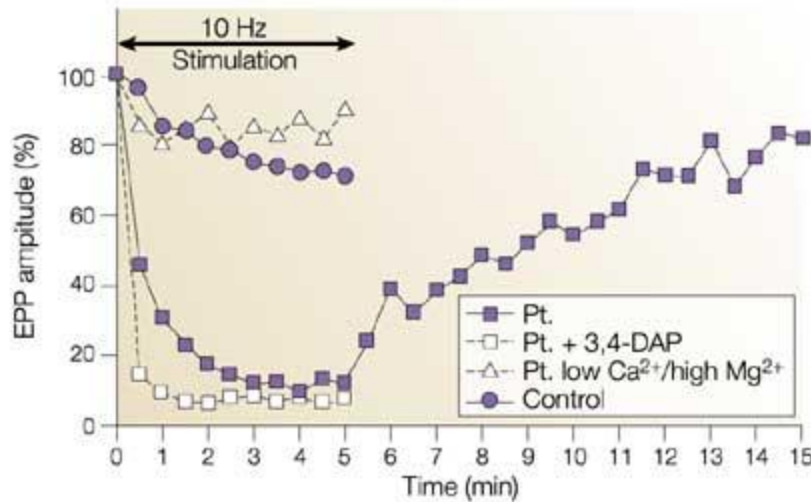

The synaptic response to the Ach, measured as the amplitude of the End Plate Potential is normal in the muscle at rest but decreases following a stimulation of 10 Hz for 5 min and recovers slowly

Defects in the synthesis of the Ach

b

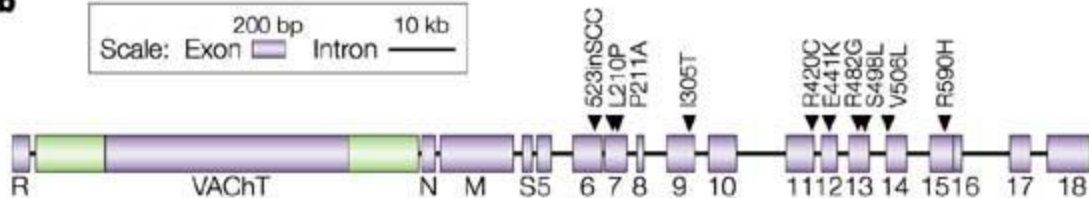

Genetic analysis of patients



10 mutations in the CHAT gene

CMS caused by defects in Acetylcholinesterase (ACHE):

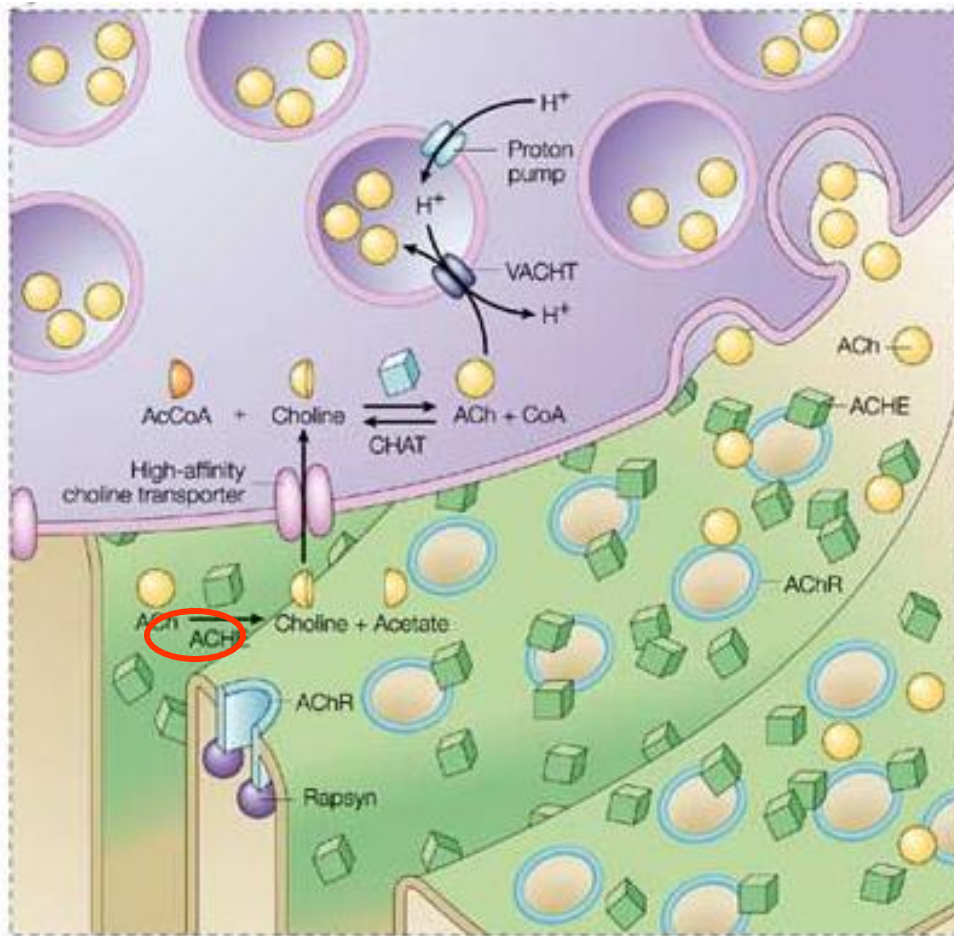

It manifests itself during early adolescence

ACHE is absent or non-functional in neuromuscular plaque

The presynaptic terminals are smaller than normal, the release of ACh is low and the synaptic response is prolonged beyond the refractory period.

Mutations in the AChE protein domains

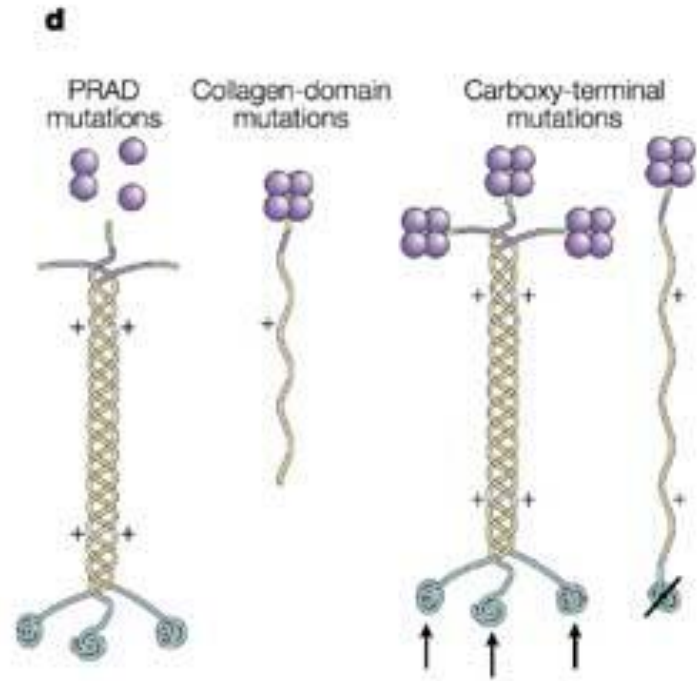
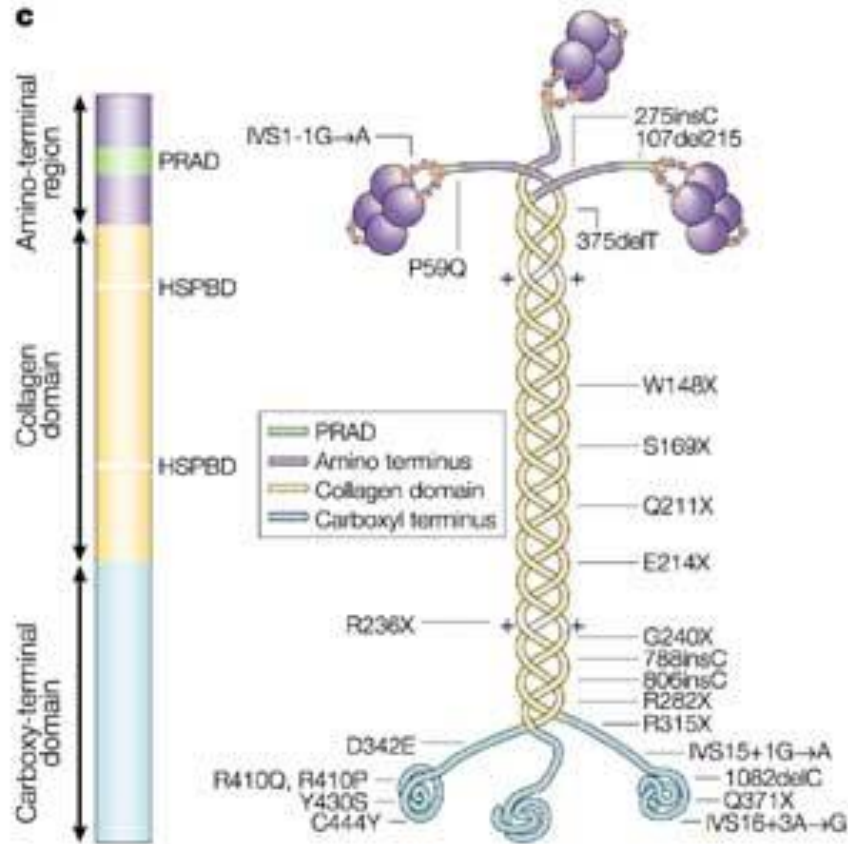

Defects in the excitability of Sarcolemma



Myotonia and Periodic Paralysis

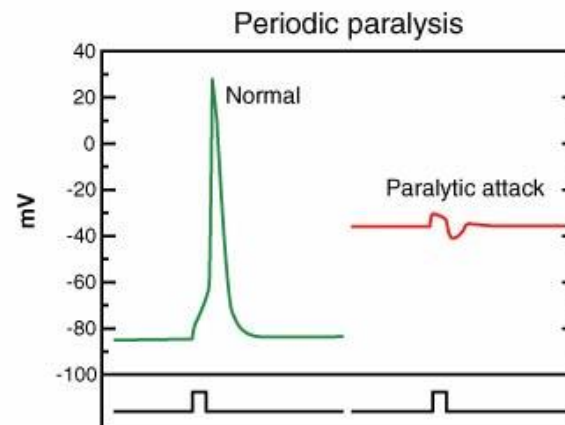
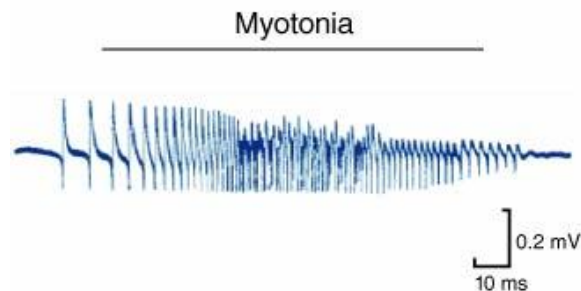
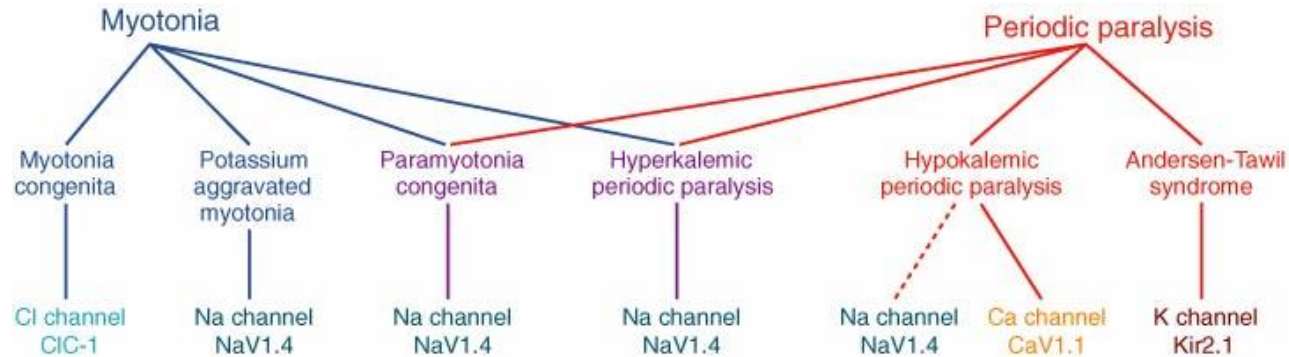

Malfunction of the Cl⁻ Channel

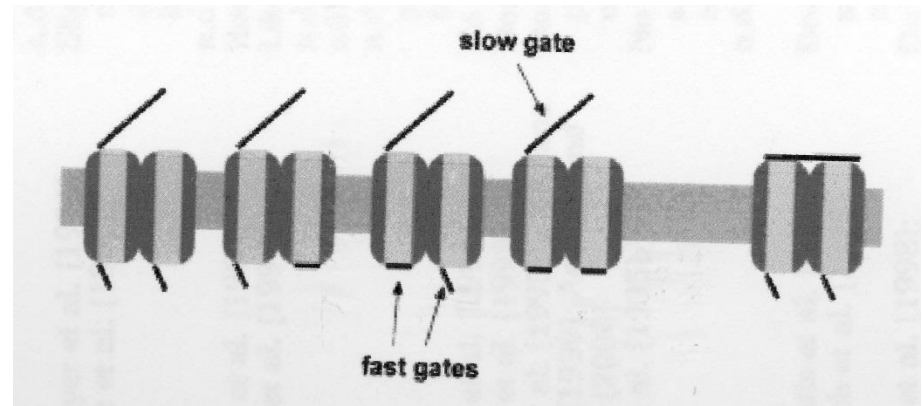
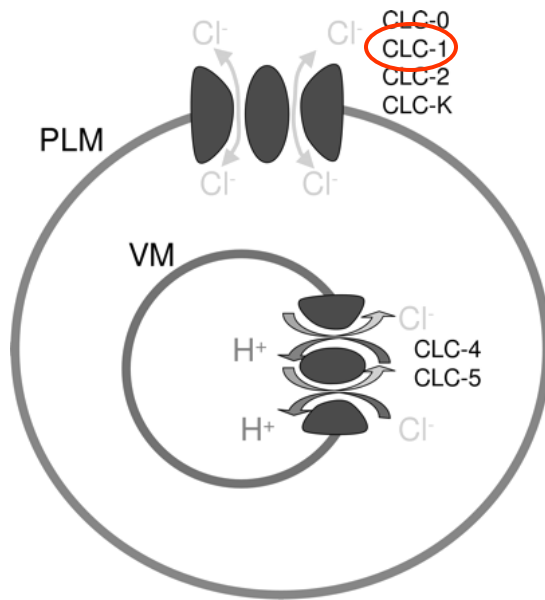

Congenital myotonia: Hyperexcitability of the plasma membrane of skeletal muscle, due to mutations in the CLCN1 gene that encodes the CLC-1 Chlorine channel, which reduce the conductance

Dystrophic myotonia: expansion of repeated nucleotides in a UTR of the CLCN1 gene which causes the transcript not to be matured

Dysfunction of the Na⁺ Channel

Mutations that increase NaV1.4 channel activation or destroy inactivation:

Myotonia aggravated by K

Paratyotonia

Mutations that increase channel inactivation:

Periodic paralysis

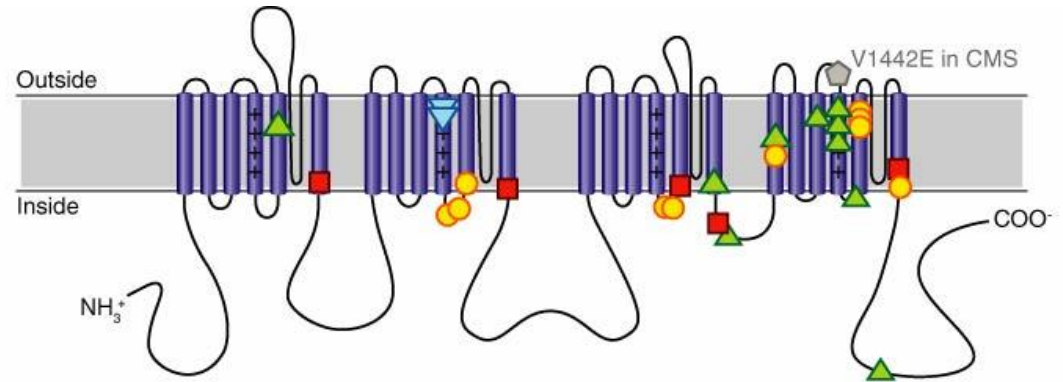

■ PAM

Val 445 Met
 Ser 804 Phe
 Ile 1160 Val
 Gly 1306 Ala / Val / Glu
 Val 1589 Met

▲ PMC

Leu 266 Val
 Val 1293 Ile
 Thr 1313 Met / Ala
 Met 1370 Val
 Leu 1433 Arg
 Arg 1448 Cys / His / Pro / Ser
 Gly 1456 Glu
 Val 1458 Phe
 Phe 1473 Ser
 Phe 1705 Ile

● HyperPP

Leu 689 Ile
 Ile 693 Thr
 Thr 704 Met
 Ala 1156 Thr
 Pro 1158 Ser
 Met 1360 Val
 Ile 1490 Leu / Met 1493 Ile
 Ile 1495 Phe
 Met 1592 Val

▼ HypoPP

Arg 669 His
 Arg 672 His / Gly / Ser



Cannon SC. 2006.
 Annu. Rev. Neurosci. 29:387–415

Ca²⁺ Channel dysfunction

Mutations in the $\alpha 1$ subunit of the Ca²⁺ channel in the sensitive region



reduced ion current density and slowed activation kinetics:

Periodic paralysis

K⁺ Channel dysfunction

Mutations in the gene coding for the Kir2.1 subunit of the K⁺ channel, expressed in skeletal muscle, in the heart and in the brain, for which the homotetrameric channel is not formed

Andersen-Tawil syndrome: periodic paralysis, ventricular arrhythmias, skeletal abnormalities

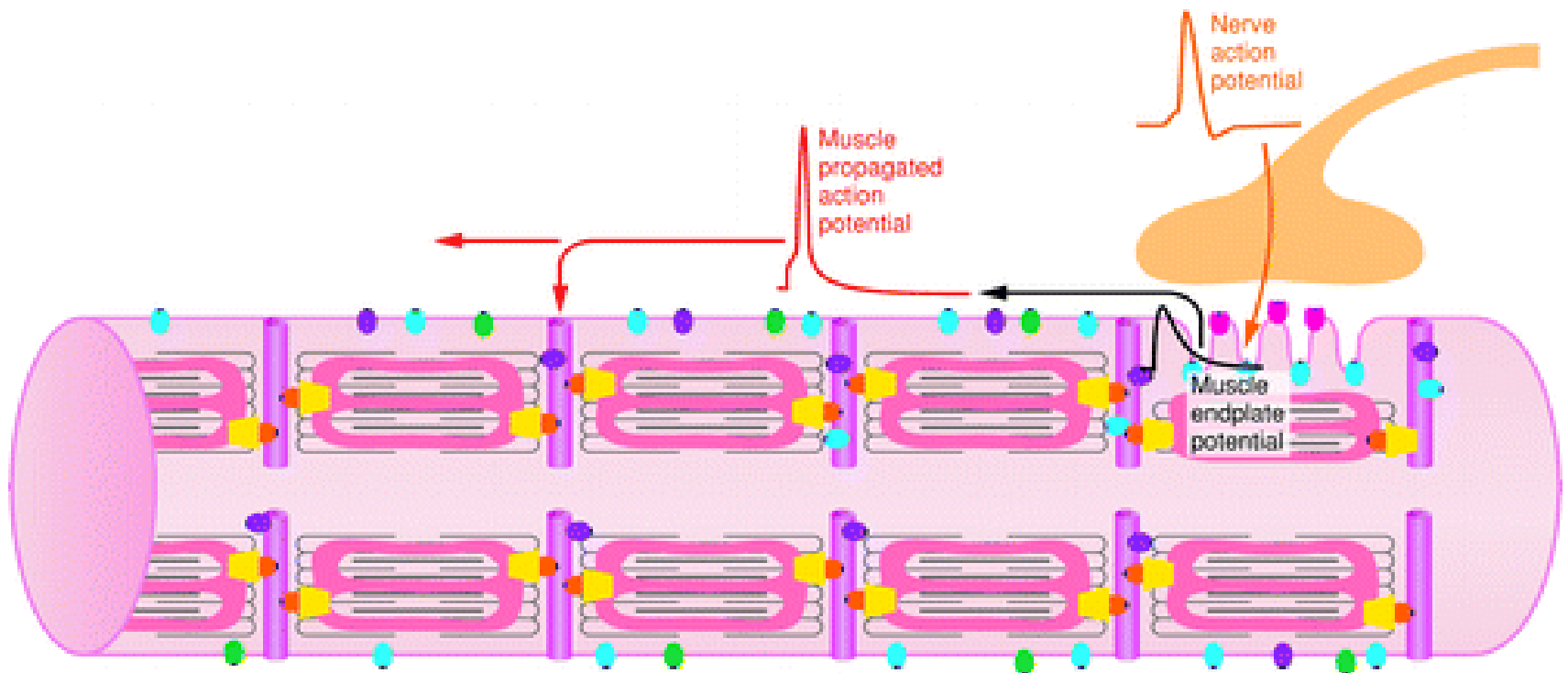

Sarcoplasmic reticulum



Transverse tubule



Actin / myosin filaments

- nAChR (congenital myasthenic syndrome)
- NaV1.4 (periodic paralysis, myotonia)
- ClC-1 (myotonia congenita)
- Kir2.1 (Andersen-Tawil syndrome)
- CaV1.1 - RyR1 (hypokalemic periodic paralysis)



Cannon SC. 2006.

Annu. Rev. Neurosci. 29:387-415

Channelopathies: Summary

- Channel mutations are an increasingly recognized cause of disease.
- Many channelopathies are episodic despite persistently abnormal channel.
- Abnormalities in same channel may present with different disease states
- Mutations/ abnormalities in different channels may lead to same disease e.g. periodic paralysis or epilepsy
- Disease mechanism often unclear despite identification of mutation.