

Solid Phase Synthesis

BRUCE MERRIFIELD

THE PROTEINS, AS THE GREEK ROOT OF THEIR NAME implies, are of first rank in living systems, and their smaller relatives, the peptides, have now also been discovered to have important roles in biology. Among their members are many of the hormones, releasing factors, growth factors, ion carriers, antibiotics, toxins, and neuropeptides. My purpose today is to describe the chemical synthesis of peptides and proteins and to discuss the use of the synthetic approach to answer various biological questions.

The story begins with Emil Fischer (1) at the turn of this century when he synthesized the first peptide and coined the name. The general chemical requirements were to block the carboxyl group of one amino acid and the amino group of the second amino acid. Then, by activation of the free carboxyl group the peptide bond could be formed, and selective removal of the two protecting groups would lead to the free dipeptide. Fischer himself was never able to find a suitable reversible blocking group for the amine function, but his student Max Bergmann, together with Leonidas Zervas, was successful (2). Their design of the carbobenzoxy group ushered in a new era. When I began working on the synthesis of peptides many years later, this same general scheme was universally in use and was very effective, having led, for example, to the first synthesis of a peptide hormone by du Vigneaud in 1953 (3). It soon became clear to me, however, that such syntheses were difficult and time consuming, and that a new approach was needed if large numbers of peptides were required or if larger and more complex peptides were to be made.

Synthesis on a Solid Matrix

One day I had an idea about how the goal of a more efficient synthesis might be achieved. The plan (4) was to assemble a peptide chain in a stepwise manner while it was attached at one end to a solid support. With the growing chain covalently anchored to an insoluble matrix at all stages of the synthesis, the peptide would also be completely insoluble and, furthermore, would be in a suitable physical form to permit rapid filtration and washing after completion of each of the synthetic reactions. The intermediate peptides in the synthesis would thus be purified by a very simple, rapid procedure rather than by the usual tedious crystallization methods. When a multistep process, such as the preparation of a long polypeptide or protein, is contemplated the saving in time, effort, and materials could be very large. The fact that all of the steps just described are heterogeneous reactions between a soluble reagent in the liquid phase and the growing peptide chain in the insoluble solid phase led to the introduction of the name "solid phase peptide synthesis."

The general scheme for solid phase synthesis is outlined in Fig. 1. It begins with an insoluble particle (large circles), which is functionalized with a group, X. The first monomer unit (small circles) is blocked at one end and at the reactive side-chain groups (black dots) and anchored to the support by a stable covalent bond. The α protecting group is then removed and the second monomer unit is added to the first by a suitable reaction. In a similar way the subsequent units are combined in a stepwise manner until the entire

polymeric sequence has been assembled. Finally, the bond holding the chain to the solid support is selectively cleaved, together with the side-chain-protecting groups, and the product is liberated into solution. Such a system offers four main advantages: it simplifies and accelerates the multistep synthesis because it is possible to carry out all the reactions in a single reaction vessel and thereby avoid the manipulations and attendant losses involved in the repeated transfer of materials; it avoids the large losses that normally are encountered during the isolation and purification of intermediates; it can result in high yields of final products through the use of excess reactants to force the individual reactions to completion; and it increases solvation and decreases aggregation of the intermediate products. It only remained to translate the general idea into a workable set of reactions.

Solid Phase Peptide Synthesis

A detailed scheme for the synthesis of peptides is shown in Fig. 2. Each of the steps has been modified in many ways, but the chemistry shown here has served well and has been applied to the synthesis of large numbers of peptides (5). The carboxyl terminal amino acid is blocked at the amino end by a *tert*-butyloxycarbonyl (Boc) group and is covalently attached to the resin support as a benzyl ester by way of the chloromethyl group. Side-chain functional groups must also be blocked, usually with benzyl-based derivatives. The synthesis depends on the differential sensitivity of these two classes of protecting groups to acid, which is greater than 1000:1. The Boc group is completely removed with 50 percent trifluoroacetic acid in dichloromethane, with minimal loss of the anchoring bond or of the other protecting groups. The resulting α -amine salt is neutralized with a tertiary amine such as diisopropyl ethyl amine, and the free amine of the resin-bound amino acid is then ready to couple with a second Boc-amino acid, which must be activated for the reaction to occur. The simplest and most often used procedure is activation with dicyclohexylcarbodiimide (6) as shown, but active esters (7), anhydrides (8), and many other activated derivatives have been successfully applied. All of these reactions are carried out under nonaqueous conditions in organic solvents that swell the resin and accelerate the rates. Dichloromethane and dimethylformamide are the solvents of choice.

To extend the peptide chain the deprotection, neutralization, and coupling steps are repeated for each of the succeeding amino acids until the desired sequence has been assembled. Finally, the completed peptide is deprotected and cleaved from the solid support. With the chemistry described here, this is accomplished by treatment with a strong anhydrous acid such as HF (9). The free peptide is then purified by suitable procedures.

Copyright © 1985 by the Nobel Foundation.
The author is a professor at the Rockefeller University, New York, NY 10021. This article is adapted from the lecture he delivered in Stockholm, Sweden, 8 December 1984, when he received the Nobel Prize in Chemistry. It is published here with the permission of the Nobel Foundation and will also be included in the complete volume of *Les Prix Nobel en 1984* as well as in the series *Nobel Lectures* (in English) published by Elsevier Publishing Company, Amsterdam and New York.

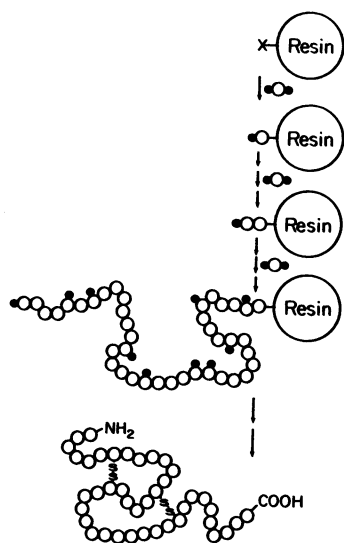

Fig. 1. The general scheme for solid phase synthesis.

It is very important that the repetitive steps proceed rapidly, in high yields, and with minimal side reactions to prevent the accumulation of excessive amounts of by-products. Much of our effort has been directed toward developing and evaluating these requirements.

The Support

The first requirement for the development of solid phase synthesis was a suitable support. After examination of many potential supports it was found that the most satisfactory one was a gel prepared by suspension copolymerization of styrene and 1 percent of *m*-divinylbenzene as cross-linking agent (4). The resulting spherical beads (Fig. 3) are about 50 μm in diameter when dry, but in organic solvents such as dichloromethane they swell to five or six times their original volume. Furthermore, as peptide chains grow the dry volume increases to accommodate the added mass and, most

important, the swollen volumes continue to increase. Values up to 25-fold have been measured and calculations indicate that the maximum expansion should be about 200-fold (10). This means that the polystyrene matrix and the pendant peptide are highly solvated during the chemical reactions and are freely accessible to diffusing reagents. The reactions occur not only at the surface of the bead but, in major part, within the interior of the cross-linked polymeric matrix. This could be demonstrated by autoradiography of a cross section of a bead containing a synthetic tritium-labeled peptide (11). At this resolution the silver grains were located uniformly throughout the bead, although the distribution is not known at the molecular level.

Because of the solvation and swelling of the beads, the reactions are rapid, with half-times of the order of seconds for both the coupling and the deprotection steps. Current efforts to evaluate the effects of mass transfer and diffusion indicate that they are very fast and not rate limiting. We believe the solid matrix not only does not have detrimental effects on the synthesis but actually has beneficial effects in certain instances. One of the well-recognized difficulties with the classical synthesis in homogeneous solution is insolubility of some intermediates. This problem can be overcome in many cases by the use of solid supports, where the peptide chain and the lightly cross-linked polymer chain become intimately mixed and exert a mutual solvating effect on one another. It becomes thermodynamically less favorable for the peptide to self-aggregate and it therefore remains available for reaction. For this to occur the solvated state of the bound peptide needs only to be favorable relative to the amorphous unsolvated state within the peptide-resin matrix (10). Similar solubilizing properties of linear polymers for covalently attached components are known, but the effect will be greater for a lightly cross-linked polymer network.

The phenomenon can be illustrated by the synthesis of oligoisoleucines (12). The standard solution synthesis failed after the tetrapeptide stage because of aggregation and insolubility, whereas the chain could be extended up to eight residues on linear polyethylene glycol. A solid phase synthesis proceeded smoothly at least as far as the dodecamer, where the experiment was stopped. There is very significant polymer chain motion in these cross-linked polystyrene resins. Both ^1H and ^{13}C nuclear magnetic resonance measurements (13) have shown that the motional rates for the aromatic groups and the aliphatic backbone atoms in CH_2Cl_2 are high and equivalent to those of linear soluble polystyrene (τ_c , 10^{-8} second). The α carbon ^{13}C resonances of model resin-supported peptides were as sharp as the solvent peak in CH_2Cl_2 or dimethylformamide and similar to small molecules in solution (τ_c , 10^{-10} second). A variety of chemical experiments also have shown polymer flexibility. For example, short resin-bound peptides that were too far apart on average to reach one another if the resin were rigid could be shown to react to the extent of 99.5 percent, indicating considerable motion of the polystyrene segments within the matrix (14).

Many other solid supports have also been examined and several have been satisfactory for peptide synthesis. These have included polymethylmethacrylate, polysaccharides, phenolic resins, silica, porous glass, and polyacrylamides, but only the polyacrylamides have seen widespread use (15). Comparative studies with polystyrene and polyacrylamide have shown that they can be equally effective, even with difficult peptides.

Automation

After each reaction the ability to purify by simple filtration and washing, and the fact that all reactions could be conducted within a single reaction vessel, appeared to lend themselves ideally to a

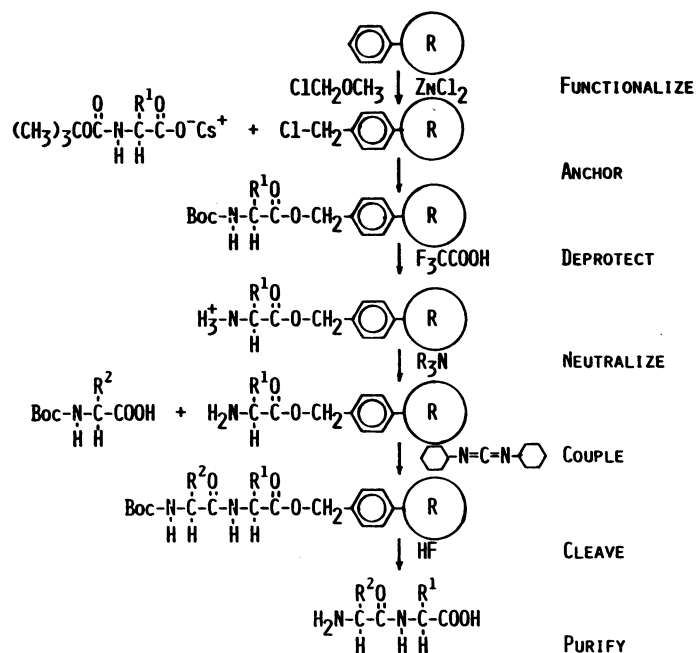

Fig. 2. A scheme for solid phase peptide synthesis.

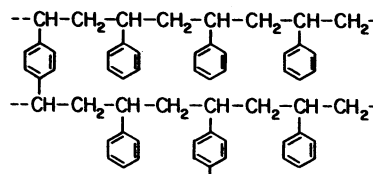
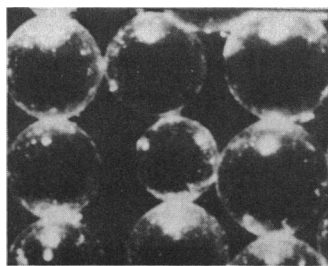

Fig. 3. Copoly(styrene-1%-divinylbenzene) resin.

mechanized and automated process. Initially, a simple manually operated apparatus was constructed. This system was first used to work out the methodology and to synthesize bradykinin (16), angiotensin (17), desaminoxytocin (18), and many other small peptides (5). To accelerate the process we undertook the design and construction (19) of the automated instrument shown in Fig. 4. The essential features were the reaction vessel, containing the resin with its growing peptide chain, and the necessary plumbing to enable the appropriate solvents and reagents to be pumped in, mixed, and removed in the proper sequence. These mechanical events were under the control of a simple stepping drum programmer and a set of timers. This was approximately the status of solid phase peptide synthesis when it was first described in *Science* in 1965 (20).

Recent Improvements in Solid Phase Peptide Synthesis

Although the earlier solid phase chemistry was very useful for making small peptides and even small proteins, it was clear that there was a need for improvement in several areas. One was the mode of attachment of the peptide to the resin. If the strategy of differential stability toward acid for the N^α and C^α groups was to be continued, a more acid-stable anchoring bond was needed. We predicted that the insertion of an acetamidomethyl group between the benzyl ester and the polystyrene matrix would increase the stability of the benzyl

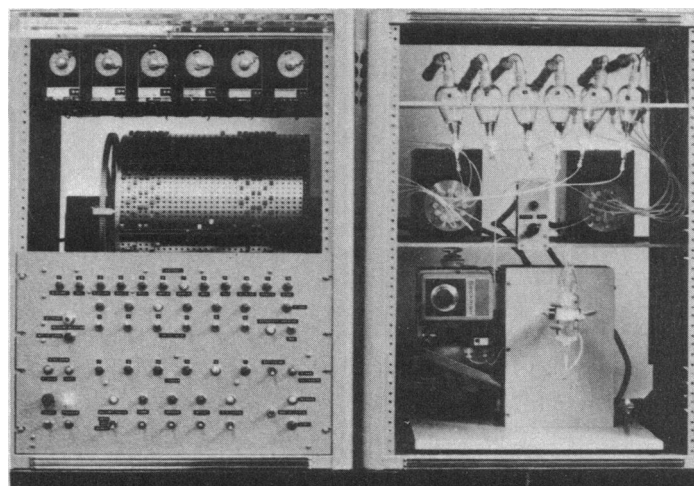
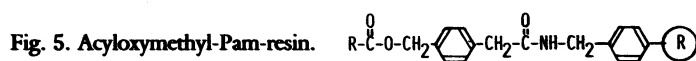

Fig. 4. An automated peptide synthesizer.

ester to trifluoroacetic acid by a factor of approximately 25 to 400 times. When such a linkage was finally constructed it was found to be 100 times more stable (21). A new synthesis of aminomethyl-resin was first developed in which *N*-hydroxymethylphthalimide and polystyrene resin were reacted under acid catalysis with F_3CSO_3H , HF, or $SnCl_4$ (22). This product was then coupled with a derivative of the COOH-terminal amino acid. Thus, N^α -Boc-aminoacyloxymethylphenylacetic acid was prepared and activated with dicyclohexylcarbodiimide. The product was the acyloxymethylphenylacetamidomethylcopoly(styrene-1 percent divinylbenzene) resin (acyloxymethyl-Pam-resin) (Fig. 5). This new preparation has the advantages that it is more acid stable, and it is made from purified, well-characterized intermediates, which give a cleaner product with fewer side reactions. It is free of chloromethyl groups that can give rise to quaternization and ion exchange reactions and is free of hydroxyl groups that can lead to peptide chain terminations via trifluoroacetylation (23).

An alternative protecting group strategy is to make use of an orthogonal system (24) in which the N^α , C^α , and the side-chain groups represent three different classes of compounds that are



cleavable by three different kinds of reactions. In that way any one of the functional groups can be selectively removed in the presence of the other two. Figure 6 illustrates such a system in which the anchoring *o*-nitrobenzyl ester is photolabile but stable to acid or nucleophiles, the side-chain groups are based on *tert*-butyl derivatives that are very acid labile but stable to light or nucleophiles, and the N^α protecting group is the dithiasuccinoyl group which is removed by nucleophilic thiols but is stable to acid and photolysis. This scheme has recently been put to the test and found to give excellent results (25).

Anhydrous hydrogen fluoride, the usual cleavage reagent for solid phase peptide synthesis, is a very strong acid (H_0 , -10.8) and is known to promote a number of side reactions. In particular it leads to the formation of carbonium ions, which then can alkylate tyrosine, tryptophan, methionine, and cysteine residues of the peptide. In addition, HF can protonate and dehydrate the side chain carboxyl of glutamic acid residues with formation of the very reactive acylium ion, which has been shown to acylate the aromatic rings of anisole and other scavengers present in the mixture. Activated glutamic residues can also form pyrrolidone (pyroglutamic)-containing products. Aspartyl residues can close in HF to the aspartimide derivative and subsequently open to produce β -aspartyl residues. All of these undesired reactions result from the S_N1 mechanism of the cleavage reaction under the usual conditions (90 percent HF + 10 percent anisole, $0^\circ C$, 1 hour). We reasoned that if conditions could be found that would change the reactions to an S_N2 mechanism in which the acidolysis is aided by a nucleophile and carbocation is never formed (Fig. 7) it should be possible to minimize or avoid these problems. James Tam and Bill Heath have succeeded in developing such conditions and in demonstrating marked improvements in solid phase peptide synthesis (26).

The problem was to find a suitable weak base that would reduce the acidity function of the HF but which would remain largely unprotonated and nucleophilic under the resulting acidic conditions. It should be a weaker base than the groups to be cleaved so that they would be largely protonated under the same conditions. Dimethyl sulfide (DMS) was found to be an ideal base for this purpose. It has a pK_a of -6.8 compared with values of -2 to -5 for the benzyl ethers, esters, and carbamates to be cleaved. It is a good solvent for HF and it is volatile and easily removed from the reaction

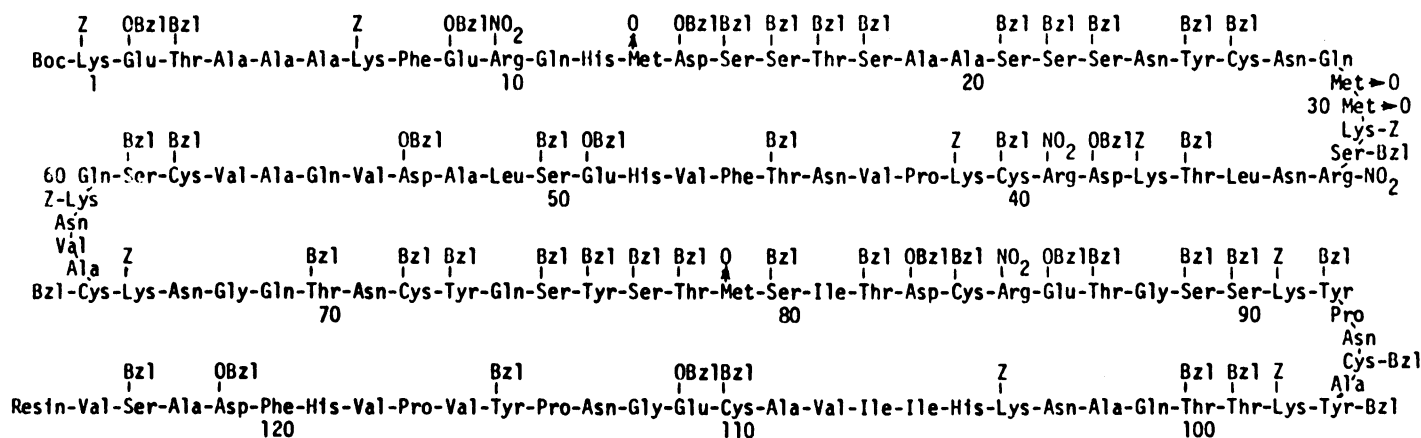

Fig. 10. Protected ribonuclease-resin.

principle the monomer may be any bifunctional compound that can be selectively blocked at one end and activated at the other.

Several schemes for the solid phase synthesis of oligonucleotides have now been developed that are rapid and give high yields. They follow almost exactly the steps shown for peptides in Fig. 2, but the chemistry is different. They employ protected nucleosides or nucleotides as monomer units and make use of either phosphotriester or phosphite triester chemistry. Instruments very similar to those developed for peptides have also been adapted recently to the nucleotides. The application of these methods to synthetic genes, site-directed mutagenesis, and synthetic nucleotide probes has become a very important field of research [see (39) for a recent review].

Some Recent Syntheses of Peptides

Very large numbers of peptides have been synthesized in recent years by the solid phase techniques that have been discussed and I cannot begin to cover them here. From our own laboratory we have reported recent synthetic studies on apamin (40), thymosin α_1 (41), glucagon (42), cecropin (43, 44), gastrin (45), and epidermal and transforming growth factors (46, 47). For this discussion I have selected examples of syntheses that serve to illustrate certain areas of interest.

The area of greatest current interest and activity is undoubtedly the synthesis of peptides for the elucidation of the immunogenic determinants of proteins and for the development of synthetic vaccines against viral and other infectious diseases. The work from Lerner's laboratory (48) has given an important impetus to this field. Synthetic antigens are also useful for the development of diagnostics and for the production of antibodies as aids in detecting and isolating unidentified gene products.

An excellent example of a synthetic peptide study leading to useful drugs is that of Manning and Sawyer on development of vasopressin analogs with high antidiuretic activity and essentially no remaining pressor activity for treatment of diabetes insipidus (49). The best was 1-deamino-[4-valine, 8-D-arginine]vasopressin. They have also discovered, through synthesis, arginine vasopressin analogs that are strong inhibitors of both antidiuretic and pressor activity for use in patients with hyponatremia due to excessive retention of water (50). The best was [1-(β -mercapto- β,β -cyclopentamethylenepropionic acid), 2-D-phenylalanine, 4-valine]-arginine-vasopressin.

In a few instances solid phase syntheses have been scaled up for commercial purposes. A good example is salmon calcitonin (51). It has been prepared in 50- to 100-g batches of highly purified peptide. This 32-residue hormone is highly effective for the treat-

ment of Paget's disease and other conditions of hypercalcemia.

As an illustration of my emphasis on the importance of new chemistry and the need to pay attention to details when utilizing solid phase peptide synthesis, I would mention some new work on the epidermal growth factor (EGF) by Bill Heath (46). EGF stimulates cellular proliferation, inhibits gastric acid secretion, and plays a role in embryonic development. This 53-residue peptide (52) (Fig. 9) is a hydrophobic, highly cross-linked, compact molecule that others have found very difficult to synthesize in the past. By using the newly developed Pam-resin support, several new protecting groups, pure reagents, the quantitative monitoring procedures, the new HF cleavage methods, and by taking all the other known precautions against side reactions, Heath succeeded in obtaining an essentially quantitative assembly of the peptide chain and a 97 percent cleavage yield, leading to a crude unpurified monomer fraction that contained 65 percent of the desired EGF. It could be readily isolated in a highly purified form that eluted from a C_{18} high-performance liquid chromatography (HPLC) column at exactly the same time as natural EGF. In the sensitive and discriminating Leydig cell growth assay the synthetic and natural EGF had identical activity.

From the accumulated data presented, I conclude that the solid phase synthesis of peptides up to 50 or somewhat more residues can be readily achieved in good yield and purity; this is a far better situation than I could have expected when this technique was first proposed.

The Synthesis of Proteins

The chemical synthesis of proteins remains a difficult task, although some preparations of these larger molecules have succeeded and have led to valuable new information. The idea of chemically synthesizing an enzyme must have occurred to many people over the years, although there was a time when such a thought would have been unacceptable even on philosophical grounds. However, from the period when enzymes were shown to be proteins and proteins were shown to be discrete organic molecules it was a goal that chemists could begin to think about. If an enzyme could be made in the laboratory, then it should become possible to learn new things about how these large and very complex molecules function. Specific changes could be made in their structures that could not be made readily by altering the native protein and data should be forthcoming that could supplement the information already obtained from the natural enzymes themselves. In this regard, a quotation from Fischer in 1906 (53) is pertinent:

Whereas cautious professional colleagues fear that a rational study of this class of compounds [proteins], because of their complicated structure and their highly inconvenient physical characteristics, would today still uncover insurmountable difficulties, other optimistically endowed observers, among which I will count myself, are inclined to the view that an attempt should at least be made to besiege this virgin fortress with all the expedients of the present; because only through this hazardous affair can the limitations of the ability of our methods be ascertained.

With the development of solid phase peptide synthesis and its automation the time seemed right to attempt the total synthesis of an enzyme. Bernd Gutte and I selected bovine pancreatic ribonuclease A because it was a small, stable protein of known amino acid sequence (54) and three-dimensional structure (55). Much of the detailed mechanism by which this enzyme hydrolyzes and depolymerizes ribonucleic acid was also known. The purpose of a chemical synthesis of this 124-residue molecule was, first, simply to demonstrate that a protein with the high catalytic activity and specificity of a naturally occurring enzyme could be synthesized in the laboratory. For the long range, the more important purpose was to provide a new approach to the study of enzymes. We believed it should be possible to modify the structure and to alter the activity and the substrate specificity of the enzyme.

The synthesis (56) was carried out on a copoly(styrene-1 percent divinylbenzene)-resin support with the general automated methods described above. The final protected derivative of ribonuclease (Fig. 10) contained a total of 67 side-chain protecting groups and had a molecular weight of 19,791. The overall yield after several purification procedures was about 3 percent based on the original amount of valine attached to the resin. There was a large (83 percent) loss of chains during the assembly of the peptide chain due to partial instability of the anchoring bond, and the accumulated losses during HF cleavage from the resin and the purification steps were another 80 percent. The crude cleaved product was oxidized in air to form the four disulfide bonds and the monomers with incorrect disulfide pairing or incorrect folding were removed from the stable protein with the correct structure by digestion with trypsin. An ammonium sulfate fractionation gave the final purified enzyme having approximately 80 percent specific activity compared with native ribonuclease A. We could not claim that our product was completely pure or that the synthesis constituted a structure proof for ribonuclease (RNase), only that the molecule showed a close chemical and physical resemblance to the native protein and that it was a true enzyme. The chemical and physical comparisons were based on amino acid analysis, enzyme digestions, peptide maps, paper electrophoresis, gel filtration, ion-exchange chromatography, and antibody neutralization. At that time we did not have HPLC or an affinity chromatography system. The substrate specificity of the synthetic enzyme was consistent with that to be expected for RNase A: it was able to cleave both large substrates such as RNA and small substrates such as C>p and therefore to catalyze both the transphosphorylation and the hydrolysis steps; it was specific for D-ribose instead of D-deoxyribose and for a pyrimidine instead of a purine at the 3' position of the phosphodiester substrate. The K_m values toward RNA were also the same for the natural and synthetic enzymes.

The purified RNase A was compared on a carboxymethyl-cellulose column with natural RNase A and with reduced and reoxidized natural RNase A. They were identical by this criterion, which was the one first used by White (57) to show that RNase A after reduction and reoxidation of the disulfide bonds was indistinguishable from the native enzyme. His was the demonstration that led to the hypothesis that the primary structure of the protein determined its tertiary structure (58). Our synthesis provided a new kind of evidence for this hypothesis. The fact that the only information put into the synthesis was the linear sequence means that the primary structure must be sufficient to direct the final folding of the

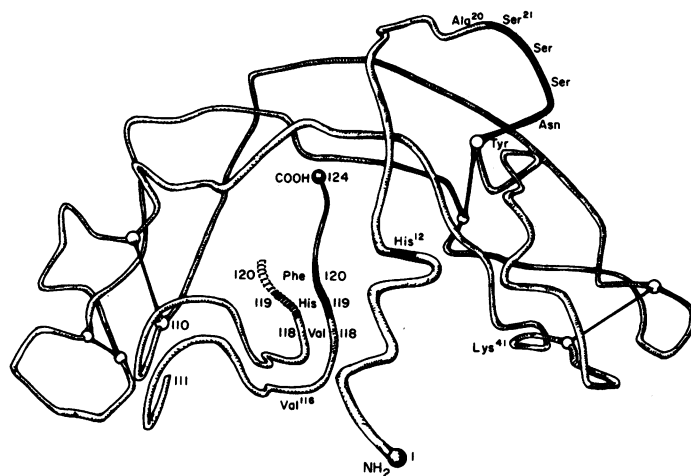

Fig. 11. A three-dimensional representation of ribonuclease fragments 1 to 20, 21 to 118, and 111 to 124 summarizing the synthetic structure-function studies.

molecule into its active tertiary structure. The synthesis of an active enzyme containing no substituents except amino acids also provided a new proof for the now well-established belief that enzymatic activity can be attributed to a simple protein containing no other components.

Simultaneously and independently of our stepwise solid phase synthesis, the peptide group at Merck Sharp and Dohme (59) succeeded in synthesizing active ribonuclease S (60) by a fragment strategy in solution, in which their carboxyanhydride method played an important role. Ten years later, Yajima and Fujii (61) reported another solution synthesis. After standard purification procedures their yield, purity, and specific activity were remarkably similar to our earlier product. Application of affinity purification then gave a product with 100 percent specific activity that could be crystallized.

Structure-Function Studies on Ribonuclease

During our stepwise synthesis we also prepared RNase(21-124) (the S protein) and RNase(26-124) and combined them noncovalently (56) with S peptide (RNase 1-20). Each had activity equivalent to that derived from natural S protein. From these results it was concluded that ribonuclease S had been synthesized and that residues 21 to 25 were not necessary for binding and reactivation to occur.

For some time we had been interested in whether or not a peptide from the carboxyl end of RNase might function in a manner similar to the S peptide from the amino end. Therefore, RNase(111-124) was synthesized (62) and mixed noncovalently with inactive RNase(1-118) prepared enzymatically from native RNase (63). Full enzymatic activity was generated. We then could show for the first time that a three-component system could be prepared that was enzymatically active (62). Thus, RNase(1-20) plus RNase(21-118) plus RNase(111-124), each containing one of the known catalytic residues of ribonuclease, were mixed noncovalently and found to generate the specific well-ordered structure necessary for substrate binding and catalytic activity.

A number of analogs of RNase(111-124) were synthesized and used to deduce the roles of various residues at the COOH-terminus of RNase. For example, the aromatic side chain of Phe¹²⁰ was shown to be important for binding of the peptide to the protein (64). From K_m and K_i data it was concluded that Phe¹²⁰ did not have a unique role in binding substrate.

X-ray data (65) indicated that uracil and cytosine residues of RNA and cyclic nucleotides bind to RNase through two different sets of hydrogen bonds. We reasoned that if the bonding could be selectively modified in synthetic analogs it should be possible to change the substrate specificity of the enzyme (66). It was found that the substrate selectivity (k_s/K_m) for the complex between synthetic [Ala¹²³]RNase(111–124) and RNase(1–118) was 19 for the ratio C>p/U>p, a considerable enhancement over the native sequence containing Ser¹²³. These and other structure-function studies on ribonuclease are illustrated in Fig. 11.

More recently, the improved solid phase methods have been applied to the synthesis of human leukocyte interferons (67). The sequence of human leukocyte interferon α_1 was first deduced from the DNA sequence of the cloned gene (68). It contains 166 amino acids, including five cysteine residues. The amino acid sequence of the isolated protein of human leukocyte interferon α_2 was also determined (69) and found to have only 155 residues. There is a high degree of homology between the two, but the latter has one deletion at Asp⁴⁴ and is missing the last ten residues predicted from the DNA sequence. We have synthesized these two proteins and also their Ser¹ analogs and purified them by reduction, gel filtration, reoxidation, gel filtration, and affinity purification on a column of supported polyclonal antibodies to human leukocyte interferon (70). The four synthetic proteins and the natural and recombinant interferon (IFN) all had 10⁸ to 10⁹ units per milligram in antiviral assays against a broad spectrum of cell lines. The development and duration of the antiviral state were also similar. Synthetic [Ser¹]IFN- α_2 and natural Hu-Le-IFN- α showed similar growth inhibition of K562 cells, and [Cys¹]IFN- α_2 and natural Hu-Le-IFN- α caused a similar increase of natural killer cell activity, whereas synthetic [Ser¹]IFN- α_2 caused a decrease. All four synthetic interferons bound to and were eluted from polyclonal antibodies to Hu-Le-IFN- α under similar conditions. No antiviral activity was found in a series of shorter synthetic fragments (67). Others have also failed to find activity in various synthetic fragments (71), but such fragments have been useful in defining the major antigenic determinants of interferon and in studies on the binding of interferon with its cell surface receptor (72).

Very recently interleukin-3 (IL-3), a protein of 140 amino acids, was synthesized by an automated solid phase procedure by these same improved conditions and analytical methods (73). The synthetic yield at each step averaged 99.4 percent based on ninhydrin monitoring and solid phase preview analysis. After cleavage and deprotection by the new low-high HF procedure (26) a 35 percent yield of oxidized, refolded crude product was obtained. The product had the expected 16,000 molecular weight on gels. It stimulated growth of a mast cell line and supported growth of bone marrow cells. The specific activity appears to be approximately 0.5 percent as high as these authors obtained with native IL-3. Several shorter synthetic fragments of IL-3 were prepared. Deletion of six residues from the amino terminus reduced the activity by a factor of 10⁴ and omission of the 1 to 17 sequence gave a totally inactive protein.

These various results on synthetic proteins are encouraging, but much more needs to be done to assure that even small proteins can be synthesized readily in high yield and purity. On the whole, I think we can be optimistic about the future.

REFERENCES AND NOTES

- E. Fischer and E. Fourneau, *Ber.* **34**, 2868 (1901).
- M. Bergmann and L. Zervas, *ibid.* **65**, 1192 (1932).
- V. du Vigneaud *et al.*, *J. Am. Chem. Soc.* **75**, 4879 (1953).
- R. B. Merrifield, *ibid.* **85**, 2149 (1963).
- _____, *Adv. Enzymol.* **32**, 221 (1969).
- J. C. Sheehan and G. P. Hess, *J. Am. Chem. Soc.* **77**, 1067 (1955).
- M. Bodanszky and J. T. Sheehan, *Chem. Ind. (London)* (1964), p. 1423.
- T. Wieland, C. Birr, F. Flor, *Angew. Chem. Int. Ed. Engl.* **10**, 336 (1971).
- S. Sakakibara and Y. Shimonishi, *Bull. Chem. Soc. Jpn.* **38**, 1412 (1965).
- V. K. Sarin, S. B. H. Kent, R. B. Merrifield, *J. Am. Chem. Soc.* **102**, 5463 (1980).
- R. B. Merrifield and V. Littau, in *Peptides 1968*, E. Bricas, Ed. (North-Holland, Amsterdam, 1968), pp. 179–182.
- S. B. H. Kent and R. B. Merrifield, in *Peptides 1980*, K. Brunfeldt, Ed. (Scriptor, Copenhagen, 1981), pp. 328–333.
- D. H. Live and S. B. H. Kent, in *Peptides: Structure and Function*, V. Hruby and D. Rich, Eds. (Pierce Chemical Co., Rockford, IL, 1983), pp. 65–68.
- K. K. Bhargava, V. K. Sarin, N. L. Tang, A. Cerami, R. B. Merrifield, *J. Am. Chem. Soc.* **105**, 3247 (1983).
- E. Atherton, D. L. J. Clive, R. C. Sheppard, *ibid.* **97**, 6584 (1975).
- R. B. Merrifield, *Biochemistry* **3**, 1385 (1964).
- G. R. Marshall and R. B. Merrifield, *ibid.* **4**, 2394 (1965).
- H. Takashima, V. du Vigneaud, R. B. Merrifield, *J. Am. Chem. Soc.* **90**, 1323 (1968).
- R. B. Merrifield, J. M. Stewart, N. Jernberg, *Anal. Chem.* **38**, 1905 (1966).
- R. B. Merrifield, *Science* **150**, 178 (1965).
- A. R. Mitchell, B. W. Erickson, M. N. Ryabtsev, R. S. Hodges, R. B. Merrifield, *J. Am. Chem. Soc.* **98**, 7357 (1976).
- A. R. Mitchell, S. B. H. Kent, B. W. Erickson, R. B. Merrifield, *Tetrahedron Lett.* (1976), p. 3795.
- S. B. H. Kent, A. R. Mitchell, M. Engelhard, R. B. Merrifield, *Proc. Natl. Acad. Sci. U.S.A.* **76**, 2180 (1979).
- G. Barany and R. B. Merrifield, *J. Am. Chem. Soc.* **99**, 7363 (1977).
- G. Barany and F. Alberici, *ibid.* **107**, 4936 (1985).
- J. P. Tam, W. F. Heath, R. B. Merrifield, *ibid.* **105**, 6442 (1983).
- _____, *ibid.*, in press.
- R. P. W. Scott, K. K. Chan, P. Kucera, S. Zolty, *J. Chromatogr.* **9**, 577 (1971).
- H. M. Geysen, R. H. Meloan, S. J. Barteling, *Proc. Natl. Acad. Sci. U.S.A.* **81**, 3998 (1984); R. A. Houghten, *ibid.* **82**, 5131 (1985).
- G. Barany and R. B. Merrifield, in *The Peptides*, E. Gross and J. Meienhofer, Eds. (Academic Press, New York, 1979), vol. 2, pp. 1–284.
- V. K. Sarin, S. B. H. Kent, J. P. Tam, R. B. Merrifield, *Anal. Biochem.* **117**, 147 (1981).
- R. A. Laursen, *J. Am. Chem. Soc.* **88**, 5344 (1966).
- H. D. Niall, G. W. Tregear, J. Jacobs, in *Chemistry and Biology of Peptides*, J. Meienhofer, Ed. (Ann Arbor Press, Ann Arbor, MI, 1972), pp. 695–699.
- J. M. Manning and S. Moore, *J. Biol. Chem.* **243**, 5591 (1968).
- B. P. Gisin, R. B. Merrifield, D. C. Tosteson, *J. Am. Chem. Soc.* **91**, 2691 (1969).
- P. Kusch, *Angew. Chem.* **78**, 611 (1966).
- J. M. Frechet and C. Schuerch, *J. Am. Chem. Soc.* **93**, 492 (1971).
- R. L. Letsinger and V. Mahadevan, *ibid.* **87**, 3526 (1965).
- M. H. Caruthers, *Science* **230**, 281 (1985).
- W. L. Cosand and R. B. Merrifield, *Proc. Natl. Acad. Sci. U.S.A.* **74**, 2771 (1977).
- T. W. Wong and R. B. Merrifield, *Biochemistry* **19**, 3233 (1980).
- S. Mojsos and R. B. Merrifield, *ibid.* **20**, 2950 (1981).
- R. B. Merrifield, L. D. Vizioli, H. G. Boman, *ibid.* **21**, 5020 (1982).
- D. Andreu, R. B. Merrifield, H. Steiner, H. G. Boman, *Proc. Natl. Acad. Sci. U.S.A.* **80**, 6475 (1983).
- J. P. Tam and R. B. Merrifield, *Int. J. Peptide Protein Res.* **26**, 263 (1985).
- W. F. Heath, unpublished results.
- J. P. Tam, H. Marquardt, D. F. Rosberger, T. W. Wong, G. J. Todaro, *Nature (London)* **309**, 376 (1983).
- R. A. Lerner, *ibid.* **299**, 592 (1982).
- M. Manning, L. Balaspiri, M. Acosta, W. H. Sawyer, *J. Med. Chem.* **16**, 975 (1973).
- M. Manning, W. A. Klis, A. Olma, J. Seto, W. H. Sawyer, *ibid.* **25**, 414 (1982).
- J. Hughes, U.S. Patent 3926-938, 16 December 1975.
- S. Cohen, *J. Biol. Chem.* **237**, 1555 (1962).
- E. Fischer, *Ber.* **39**, 530 (1906). Translation taken from J. P. Greenstein and M. Winitz, *Chemistry of the Amino Acids* (Wiley, New York, 1961), vol. 2, p. 1816b.
- C. H. W. Hirs, S. Moore, W. H. Stein, *J. Biol. Chem.* **235**, 633 (1960).
- G. Kartha, J. Bello, D. Harker, *Nature (London)* **213**, 862 (1967).
- B. Gutte and R. B. Merrifield, *J. Am. Chem. Soc.* **91**, 501 (1969); *J. Biol. Chem.* **246**, 1922 (1971).
- F. H. White, Jr., *J. Biol. Chem.* **236**, 1353 (1961).
- C. B. Anfinsen and E. Haber, *ibid.*, p. 1361.
- R. Hirschmann *et al.*, *J. Am. Chem. Soc.* **91**, 507 (1969).
- F. M. Richards, *C. R. Trav. Lab. Carlsberg Ser. Chim.* **29**, 329 (1955).
- H. Yajima and N. Fujii, *J. Am. Chem. Soc.* **103**, 5867 (1981).
- M. C. Lin, B. Gutte, S. Moore, R. B. Merrifield, *J. Biol. Chem.* **245**, 5169 (1970).
- M. C. Lin, *ibid.*, p. 6726.
- B. Gutte, M. C. Lin, D. G. Caldi, R. B. Merrifield, *ibid.* **247**, 4763 (1972).
- H. W. Wyckoff *et al.*, *ibid.* **245**, 305 (1970).
- R. S. Hodges and R. B. Merrifield, *ibid.* **250**, 1231 (1975).
- R. B. Merrifield, in *Peptides: Structure and Function*, V. J. Hruby and D. H. Rich, Eds. (Pierce Chemical Co., Rockford, IL, 1983), pp. 33–44.
- N. Mantel *et al.*, *Gene* **10**, 1 (1980).
- W. P. Levy *et al.*, *Proc. Natl. Acad. Sci. U.S.A.* **78**, 6186 (1981).
- M. Krim, I. Mecs, E. L. Merrifield, F. Fox, V. Sarin, R. B. Merrifield, TNO-ISIR Meeting, Heidelberg, Federal Republic of Germany, 21 October 1984.
- H. Arnheiter, R. M. Thomas, T. Leist, M. Fountoulakus, B. Gutte, *Nature (London)* **294**, 278 (1981).
- H. Arnheiter, M. Ohno, M. Smith, B. Gutte, K. C. Zoon, *Proc. Natl. Acad. Sci. U.S.A.* **80**, 2539 (1983).
- I. Clark-Lewis *et al.*, *Science* **231**, 134 (1986).
- I owe a very special debt of gratitude to my teachers, Dr. M. S. Dunn of the University of California, Los Angeles, and Dr. D. W. Woolley of the Rockefeller University. Several of the past and present members of my laboratory have been referred to here, but to the many others who have not been specifically mentioned I am equally grateful because they all have contributed to the progress of our work. Finally, I wish to acknowledge the continuing support of the Rockefeller University and of the National Institutes of Health of the United States.

Science

Solid phase synthesis

B Merrifield

Science **232** (4748), 341-347.
DOI: 10.1126/science.3961484

ARTICLE TOOLS

<http://science.sciencemag.org/content/232/4748/341>

REFERENCES

This article cites 61 articles, 17 of which you can access for free
<http://science.sciencemag.org/content/232/4748/341#BIBL>

PERMISSIONS

<http://www.sciencemag.org/help/reprints-and-permissions>

Use of this article is subject to the [Terms of Service](#)

Science (print ISSN 0036-8075; online ISSN 1095-9203) is published by the American Association for the Advancement of Science, 1200 New York Avenue NW, Washington, DC 20005. The title *Science* is a registered trademark of AAAS.

Copyright © 1986 The Authors, some rights reserved; exclusive licensee American Association for the Advancement of Science. No claim to original U.S. Government Works.