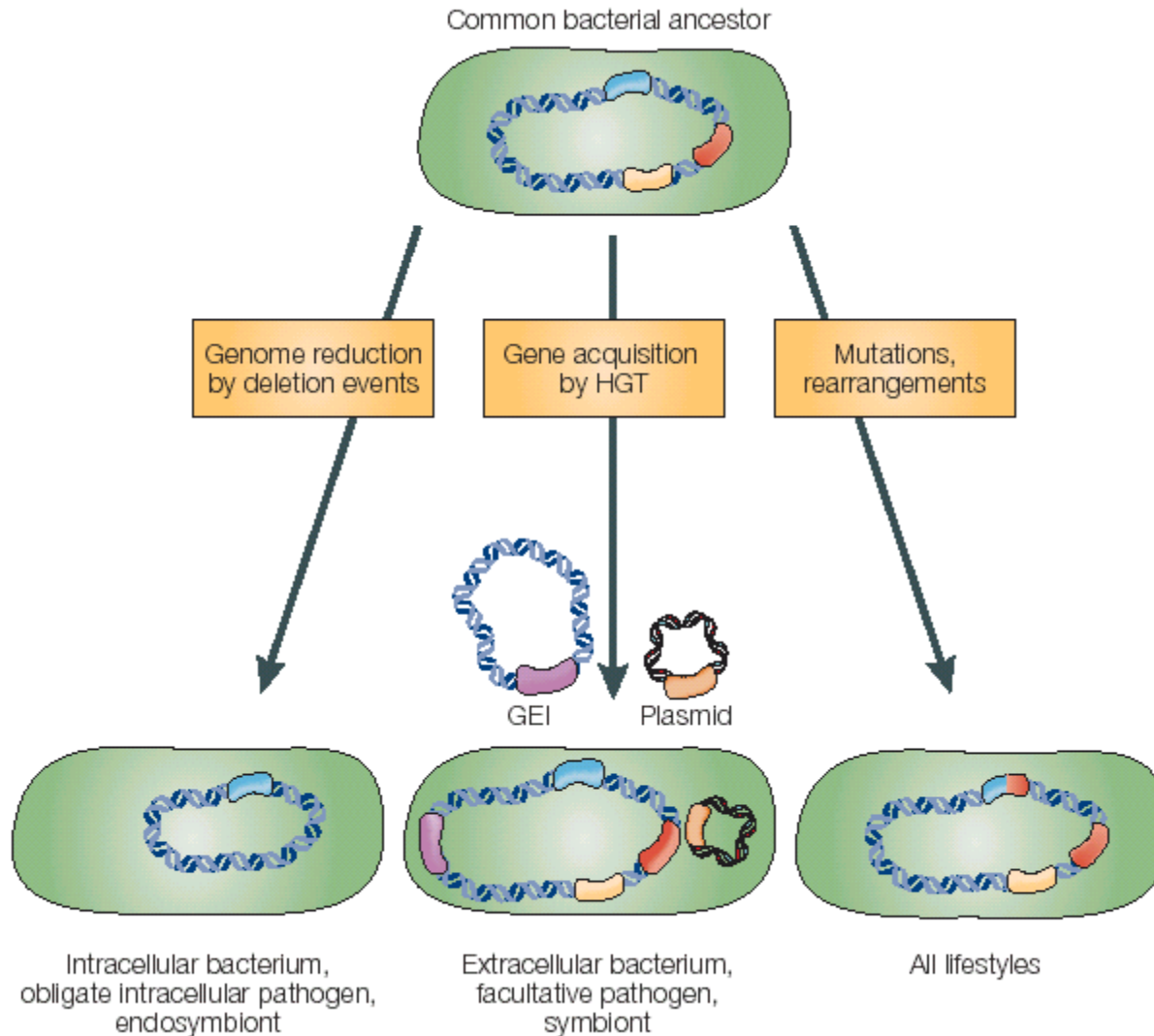
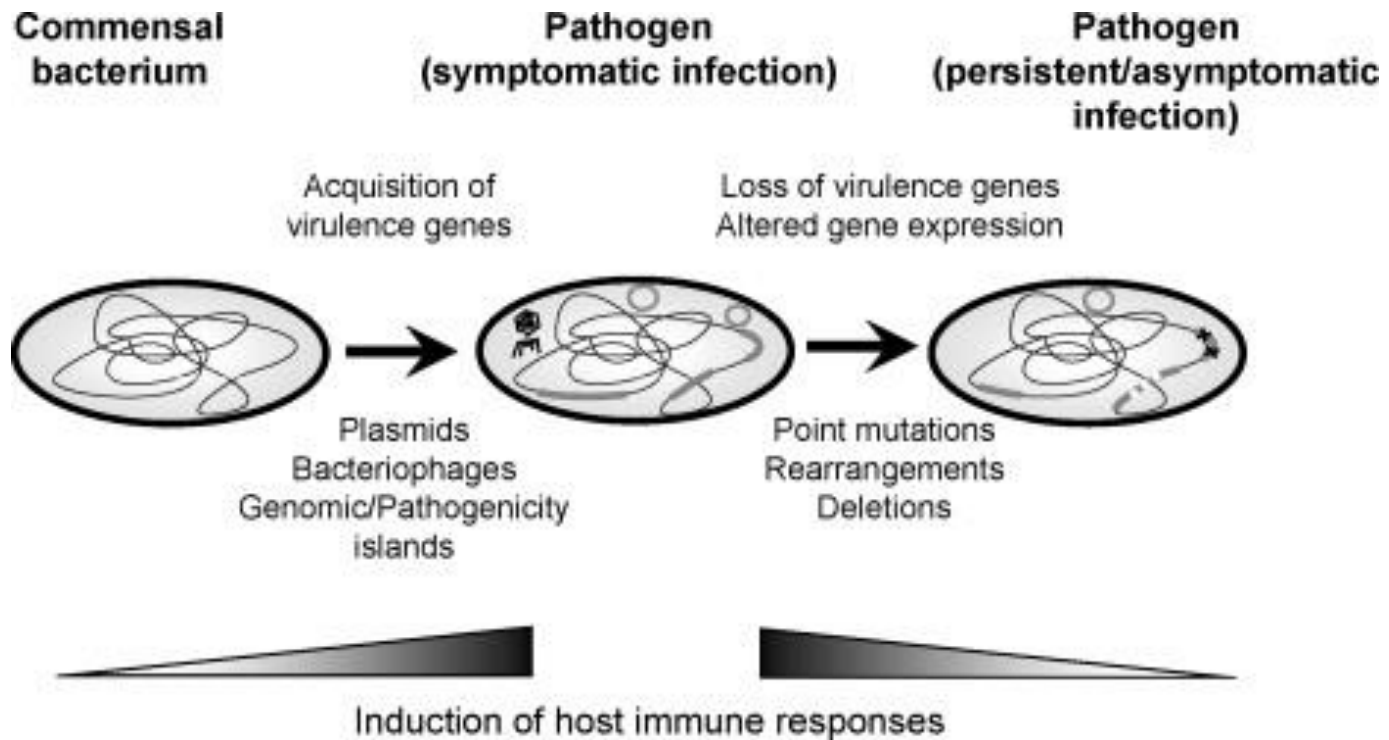


# Evolution of a bacterial pathogen: major strategies



# Impatto della plasticità genomica nell'adattamento dei batteri patogeni



L'acquisizione di elementi genetici mobili quali batteriofagi, plasmidi o isole genomiche contribuisce all'evoluzione dei patogeni dalle varianti commensali. Durante l'infezione, la fluidità genomica tramite riarrangiamenti, delezioni o mutazioni puntiformi determina l'insorgenza di ceppi patogeni persistenti oppure determinan una down-regolazione di alcuni geni . Nei ceppi persistenti si nota un accumulo di mutazioni.

## Genoma di *E.coli* : esempio di grande variabilità

La sequenza dell'intero genoma di *E.coli* ha rivelato una variabilità intraspecie estremamente elevata

Sono disponibili 4 sequenze genomiche di *E.coli*

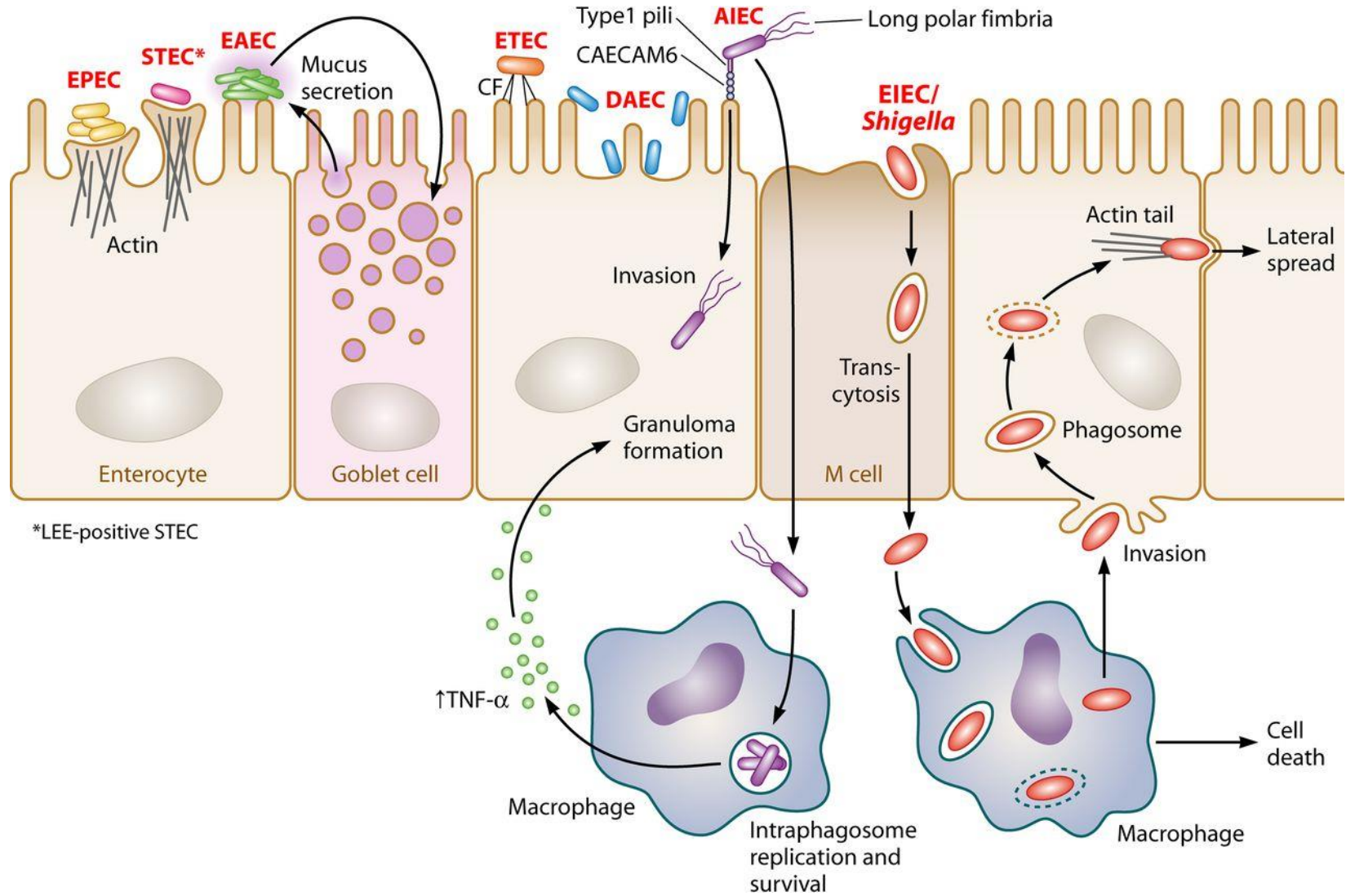
Analisi genomica comparativa ha rivelato che *E.coli* 0157 ha un genoma di 1 Mb più grande di quella di *E.coli* K12 e circa 25% dei geni non sono conservati nel genoma di *E.coli* K12.

Molti dei geni presenti in 0157 si pensa siano stati acquisiti tramite eventi di trasferimento orizzontale e tramite elementi genetici mobili quali fagi, profagi e sequenze IS

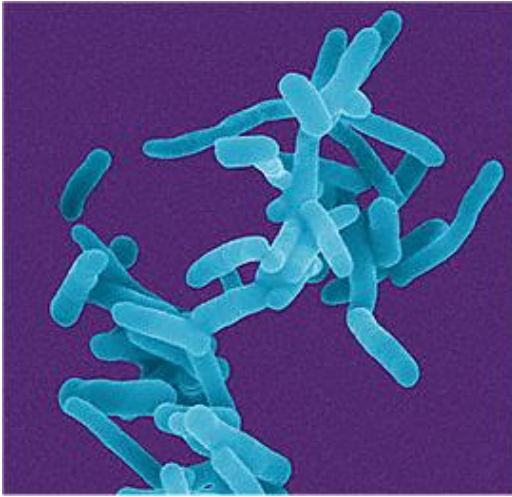
Soltanto 3.000 geni sono in comune tra i 4 genomi di *E.coli* mentre erano 4.000 tra *E.coli* K12 e 0157

I 3000 geni comuni presentano SINTENIA suggerendo una base di trasmissione verticale

# Adherence patterns of enteric E. coli.



# Shigella



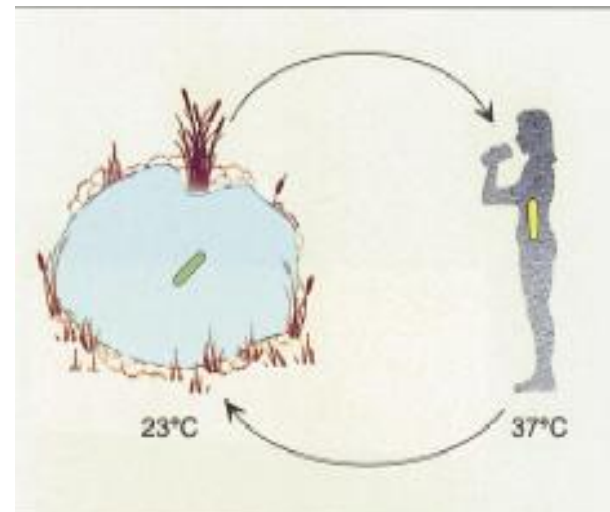
- is a Gram negative, facultative anaerobe
- is an intracellular pathogen
- is the etiological agent of bacillary dysentery, an acute diarrheal disease
- causes 160 million of episodes, determining 1.1 million deaths/year in children and infants in developing countries.

Subgrouped into four "species":

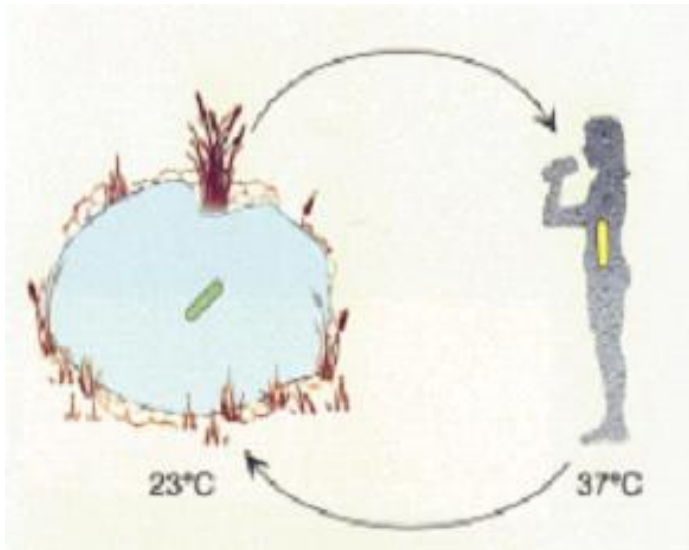
- *Shigella flexneri*
- *Shigella dysenteriae*
- *Shigella boydii*
- *Shigella sonnei*

Due to the high level of genome homology, *Shigella* is now considered among *E.coli*

Infection is spread via fecal-oral route

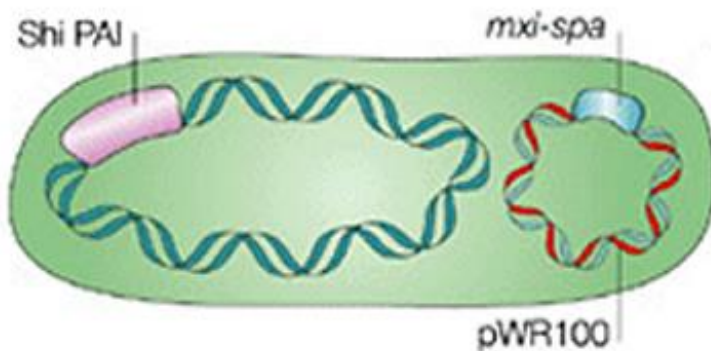


# Shigella



- is an intracellular pathogen causing human dysentery, a highly infectious disease
- is able to invade epithelial host cells and to manipulate the immune cell functions
- is able to survive in the outer environment and is acquired mainly from contaminated water

- shares a high genome homology with *E.coli* (belongs to the same pathovar)
- has a genome characterized by a large pINV plasmid, acquired by HGT during the transition towards pathogenicity



# Shigella è ormai considerato uno dei modelli di *E. coli* patogeni

## Organizzazione strutturale del genoma di Shigella

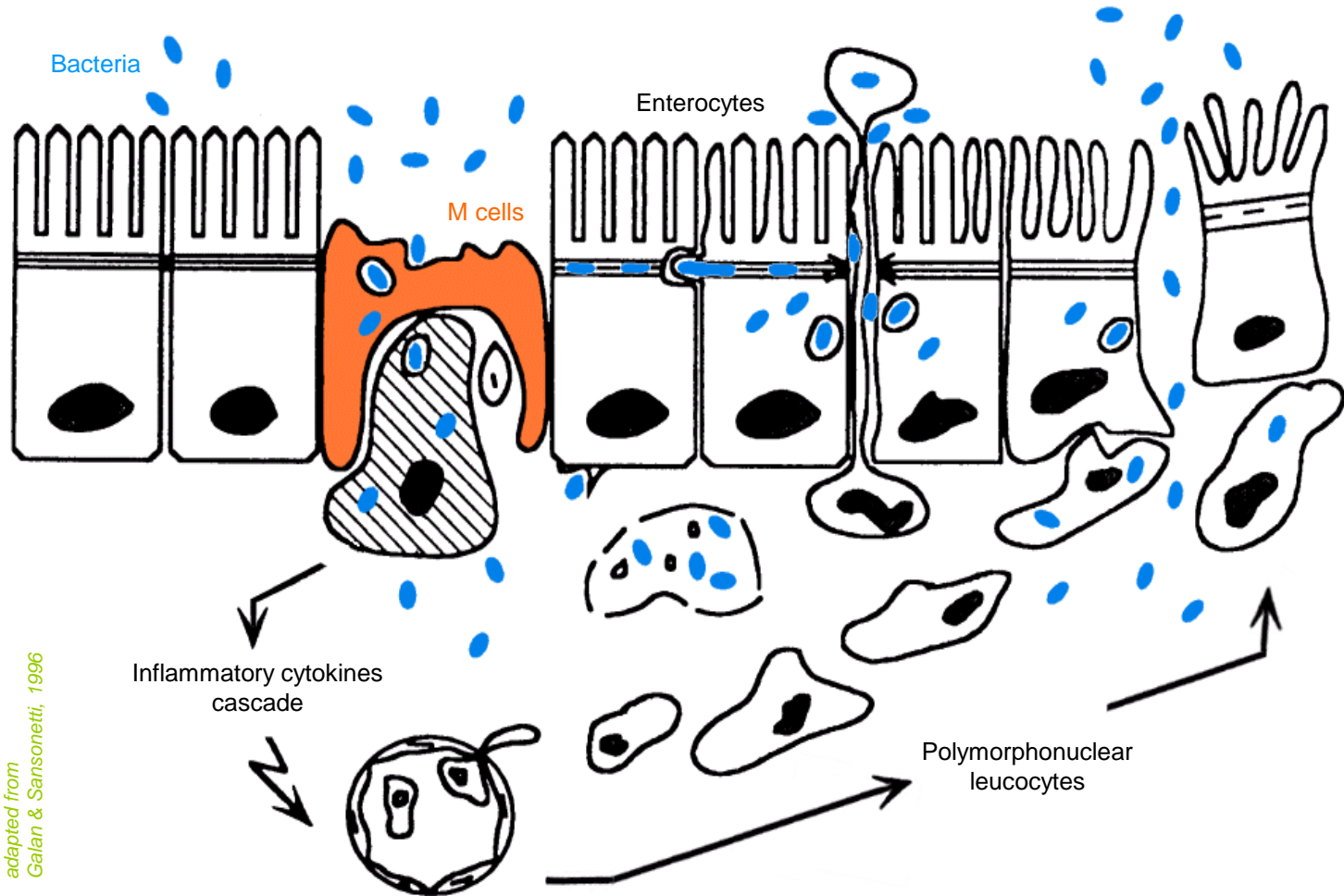
Un singolo cromosoma circolare di 4.599.354 basi  
leggermente più piccolo rispetto ad *E. coli* K12 4.639.221

L'organizzazione riflette quella descritta per *E. coli* O157 e per gli *E. coli* UTI :  
larghe regioni di colinearità interrotte da isole genomiche acquisite per HGT (15 riarrangiamenti sup. alle 5 Kb)

7 operoni rRNA organizzazione alterata rispetto a *E. coli* K12  
98 geni tRNA tra i quali 3 copie di un nuovo cluster di 4 tRNA  
ciascuna inserita in un profago .

Ampie inversioni nelle regioni **ORI** e **TER**, probabilmente IS mediate

# Model for *Shigella* invasion of the colonic mucosa



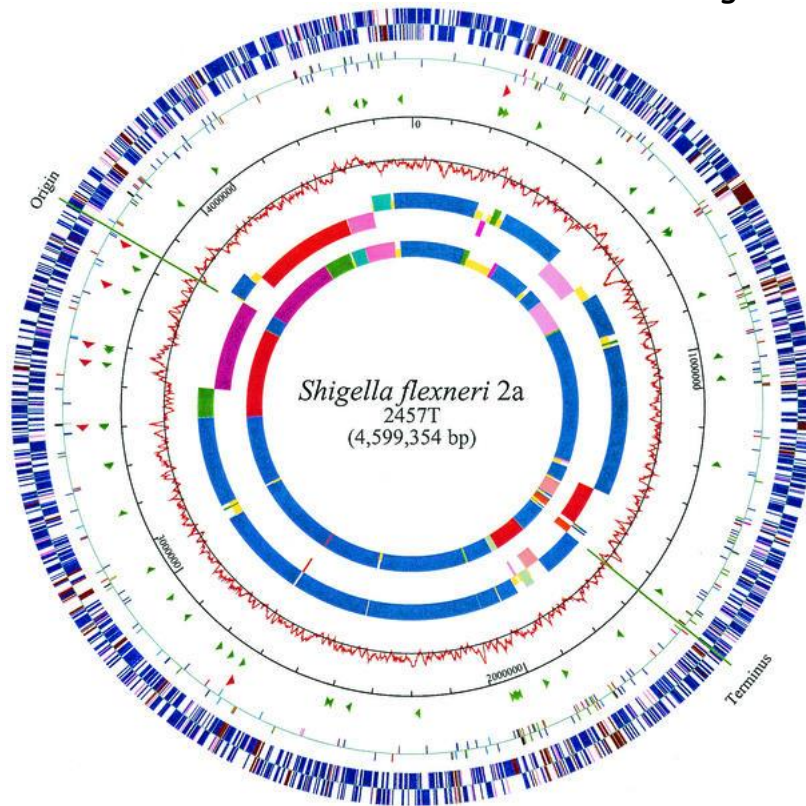
adapted from  
Galan & Sansonetti, 1996



# Shigella and E.coli genomes are highly homologous

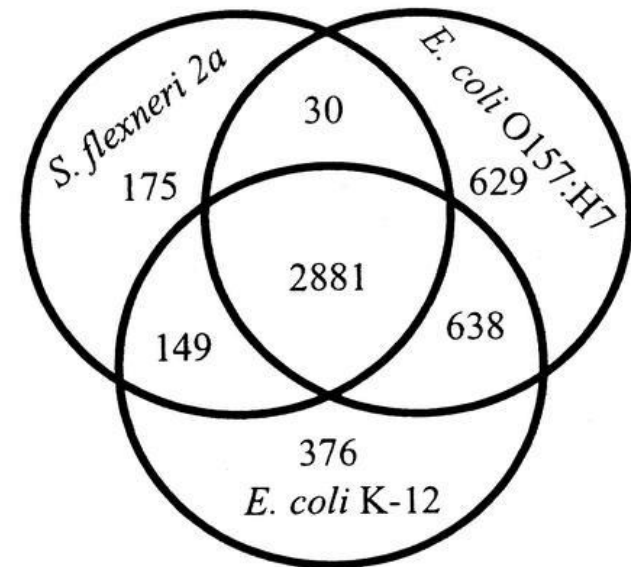
## The genome of Shigella

- Large regions of colinearity with the *E. coli* genome
- High percentage of IS (6.7% of the genome, 1.5% in *E. coli*)
- Extensive gene decay; high fraction of pseudogenes (8%)



■ genes common to *Shigella* and *E. coli*  
■ genes unique to *Shigella*

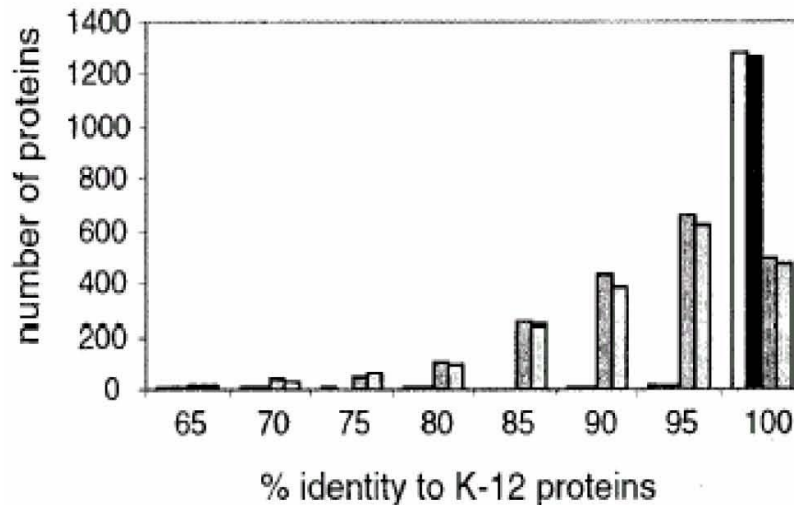
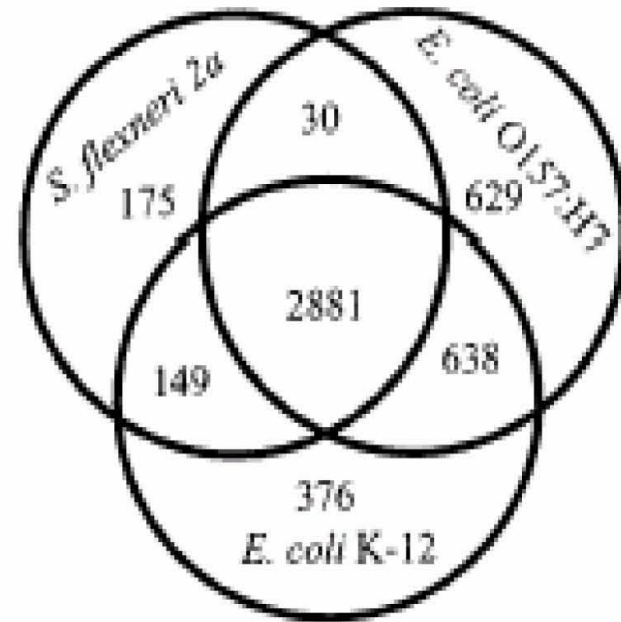
## Number of intact proteins



The number of proteins shared by *Shigella* and *E. coli* is very high, confirming the presence of an extensive common backbone

Nonostante le differenze vi è un' elevato livello di omologia tra Shigella e E.coli

Esistenza di un'ossatura centrale comune



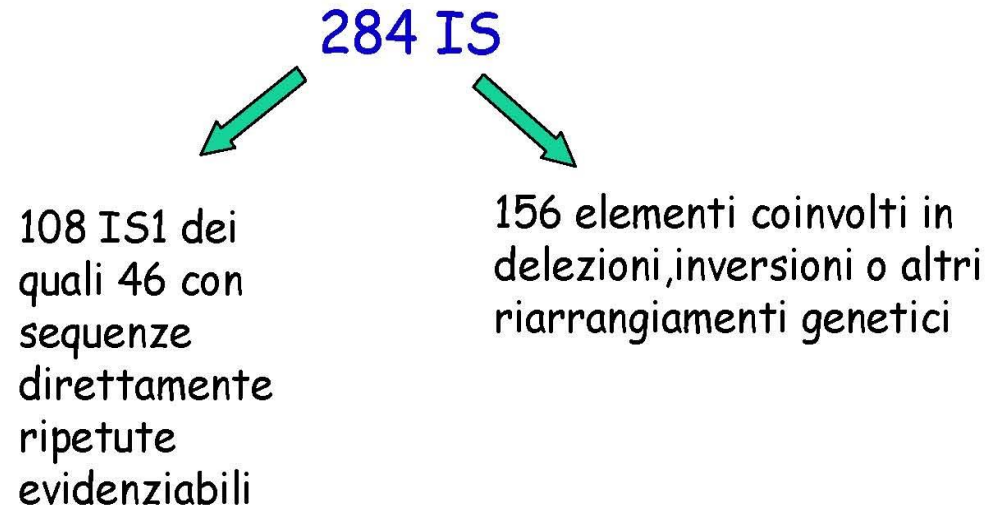
La gran parte delle proteine di *S. flexneri* ed *E. coli* sono identiche vi è diversità invece con le proteine di *Salmonella*

## Distribuzione degli elementi IS

Gli elementi IS identificati costituiscono il 6.7% del cromosoma (309.4 kb) in contrasto con gli altri batteri (0-4%).

In *E.coli* 1.5% in *Y.pestis* 3%

Unica eccezione *Archea Sulfolobus solfataricus* 10% di IS (genoma di 2.9 Mb)



## Quante isole ci sono?

37 isole che codificano almeno un gene ( non correlato ad IS)

Mostrano omologia con proteine presenti in diversi microrganismi patogeni per piante, animali e con stili di vita diversi

Categoria funzionale	N.Orf	Specie con omologia
Virulenza	10	<i>S.flexneri, Y.pestis</i>
Adesine	7	<i>Salmonella, E.coli path, Actinomiceti</i>
Regolazione	5	<i>E.coli 0157, Salmonella</i>
Metabolismo energetico	31	<i>Listeria, Caulobacter, Salmonella</i>
Cattura del ferro	12	<i>Salmonella, E.coli path.</i>
Res. a composti organici/ inorganici	7	<i>E.coli path, Caulobacter, Agrobacterium</i>
Trasporto	11	<i>Salmonella, E.coli path</i>
Struttura cellulare	9	<i>Salmonella, E.coli path</i>
Biosintesi/metaboliti centr	17	<i>Salmonella, E.coli path, V.cholerae</i>
Funzione sconosciuta	68	<i>Salmonella, Pseudomonas, Synorizobium</i>

## Plasmidi

Grande plasmide di virulenza circa 218-220 kb  
contiene tutti geni coinvolti nel processo di invasività

2 piccoli plasmidi multicopie

In alcuni ceppi plasmide criptico di 165 kb simile al plasmide R27-like di *Salmonella* e al plasmide pMT1 di *Y.pestis*.

## PSEUDOGENI

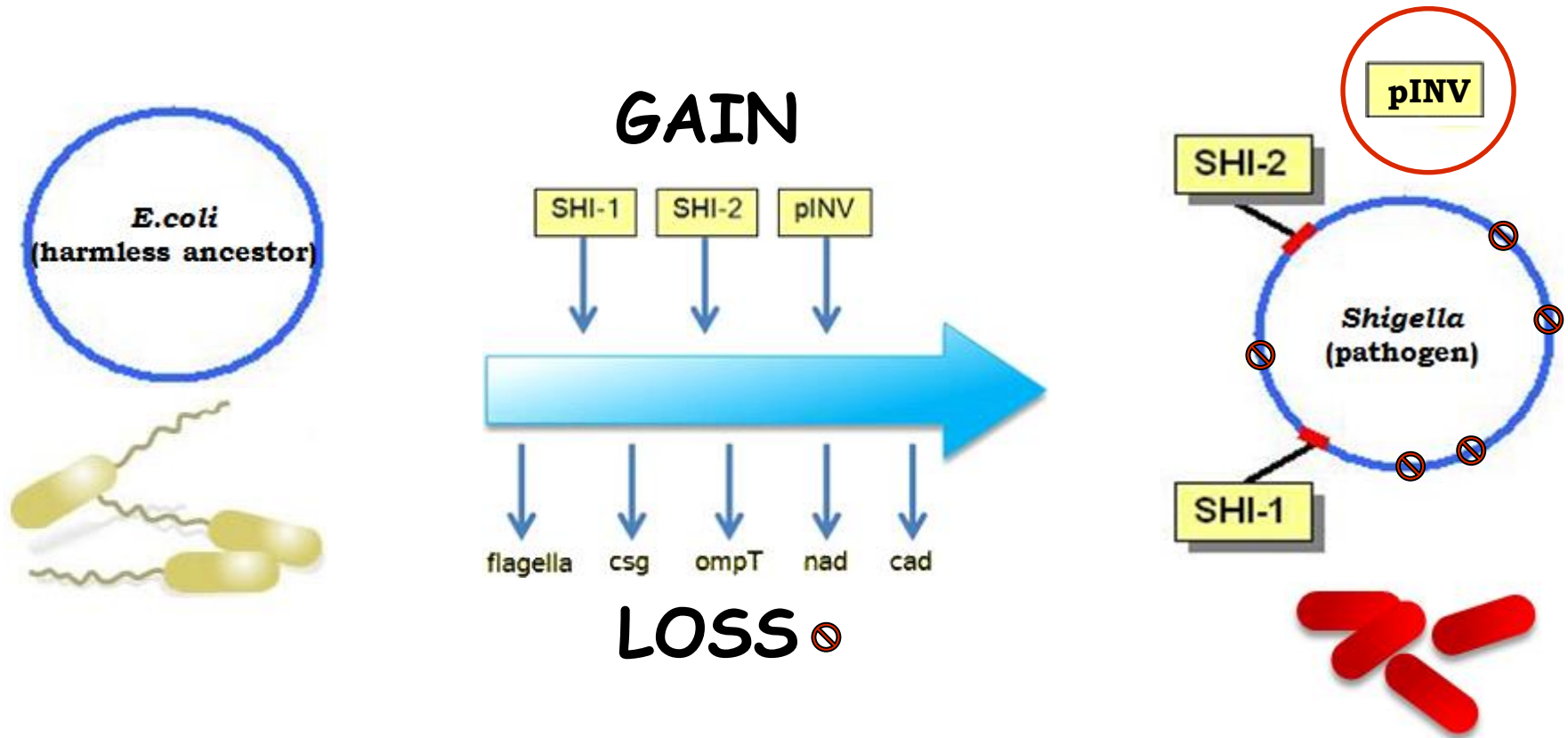
372 geni disrotti (8.1% genoma) ottenuti per :

- perdita di nucleotidi
- mutazioni puntiformi
- delezioni
- riarrangiamenti mediati da IS

879 geni di *E.coli* sono persi:

124	Trasporto
63	Struttura cellulare
62	Regolazione
58	Metabolismo

# The evolutionary pathway from *E.coli* to *Shigella*: a good example



The major event that gave rise to the *Shigella* /EIEC pathotype has been the acquisition of the large virulence plasmid (pINV)

# Outline

## Gain of genes ...

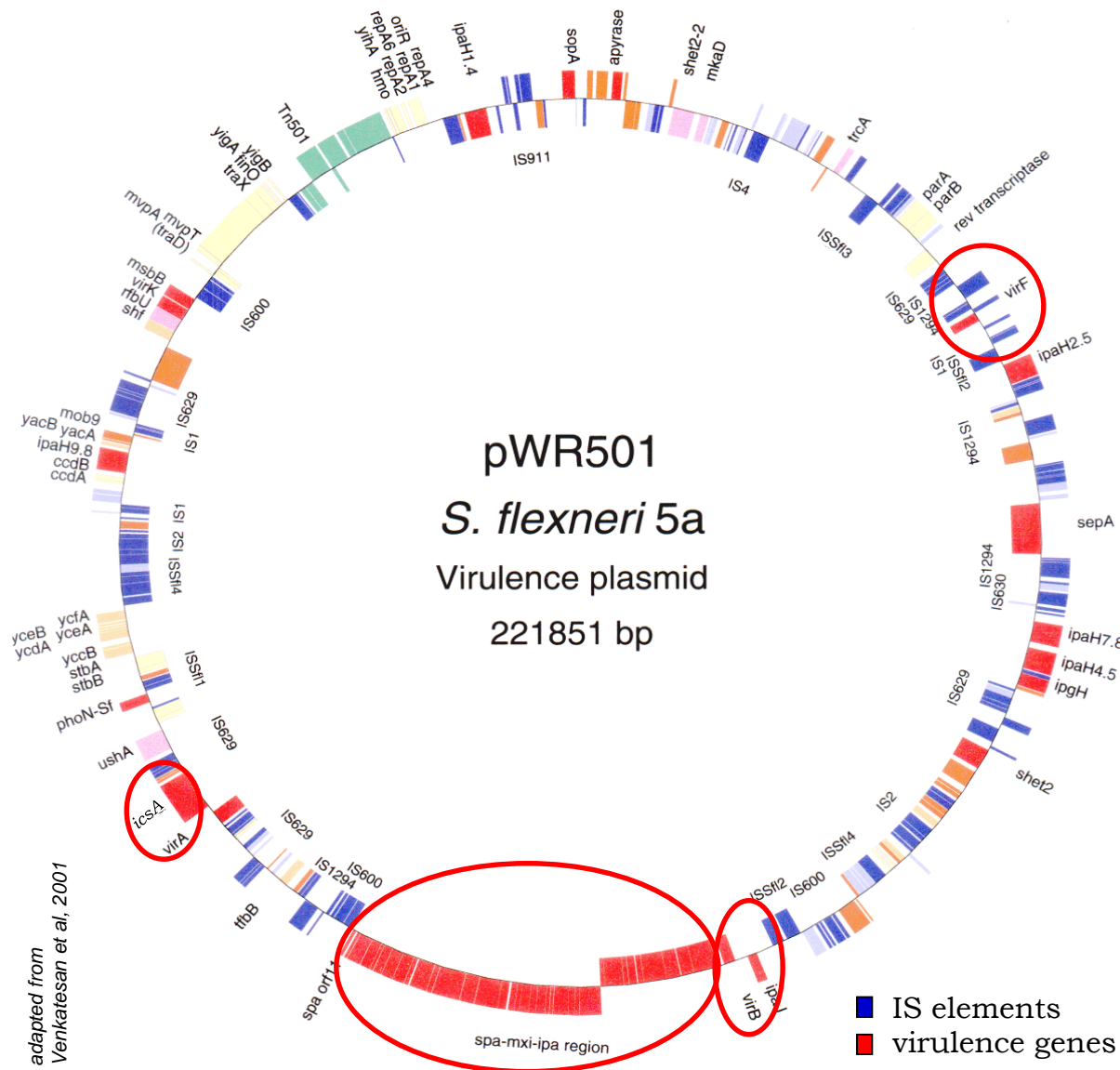
- Strategies adopted by *Shigella* to allow the expression of plasmid-encoded virulence genes

## Loss of genes ...

- Silencing of genes involved in the polyamine pathways
- Loss of genes carried by a lysogenic phage



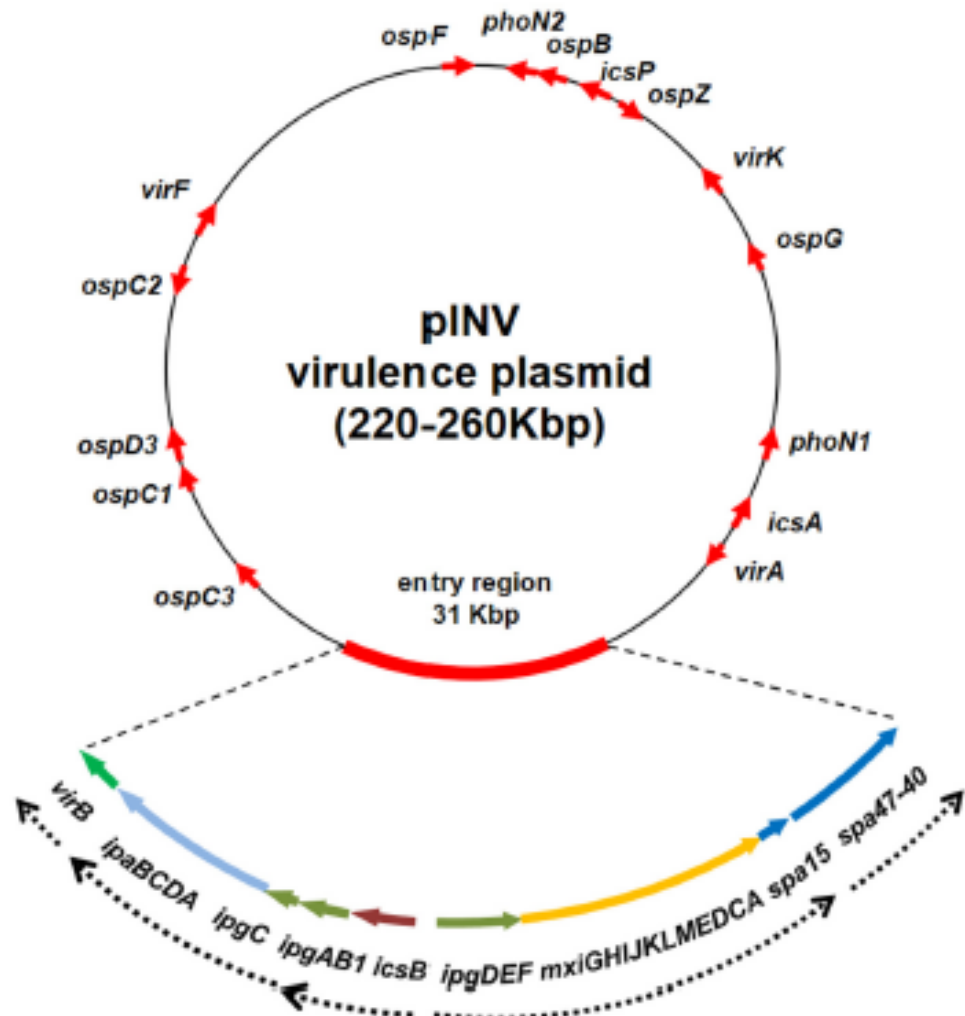
# pINV of *Shigella* contains all virulence determinants



## pINV

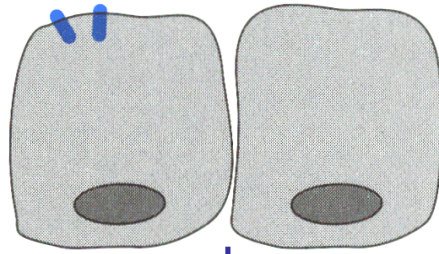
carries necessary genes for:

- adhesion
- invasion
- spreading  
coded by *spa-mxi-ipa* region and *icsA*
- positive regulation  
of virulence genes  
coded by *virF* and *virB*

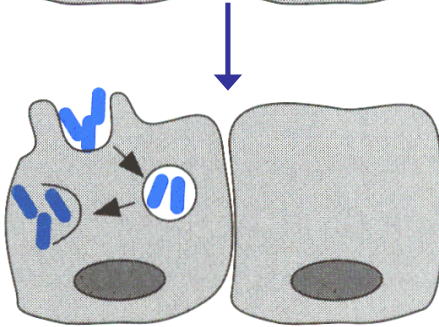


**FIGURE 1 |** Genetic map of the pINV of *Shigella* and EIEC strains. The red arrows indicate major virulence determinants. Due to the variability in position and number, the *ipaH* genes are not shown. The genetic organization of the entry region is shown in detail, with dashed arrow lines indicating known transcriptional units. The entry region organization is based on the sequence of plasmid pWR100 (Venkatesan et al., 2001) while the entire plasmid is freely drawn to provide the layout of a typical pINV plasmid (the figure is not to scale).

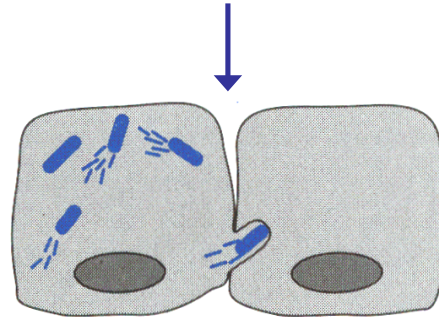
IpaD



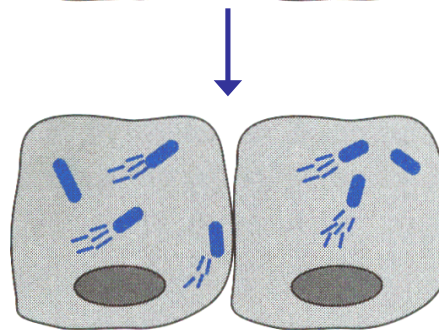
IpaB,  
IpaC




IcsA  
(VirG)

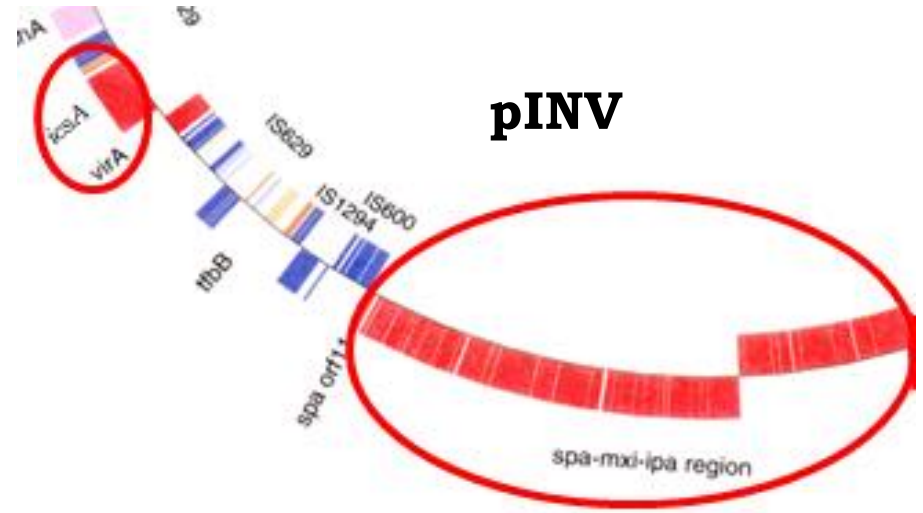


IcsB

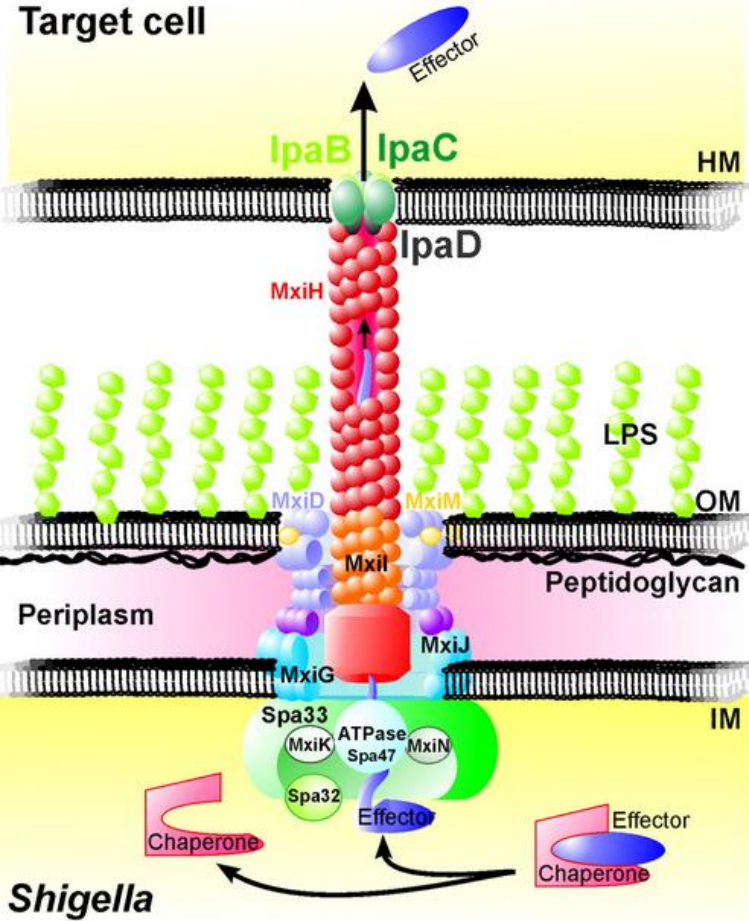


Actin  
filaments 

Nucleus 

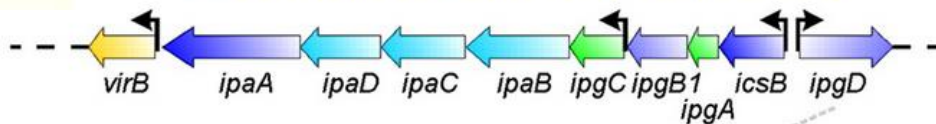


Proteins involved in the invasion process, as well as proteins of Type III Secretion System, are encoded by the virulence plasmid (pINV) and are expressed only at the host temperature (37°C)

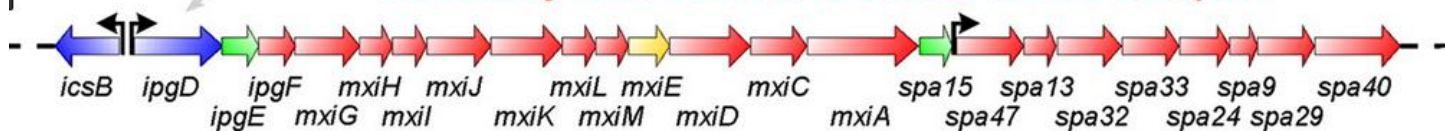


Organizzazione del sistema di T3SS di Shigella

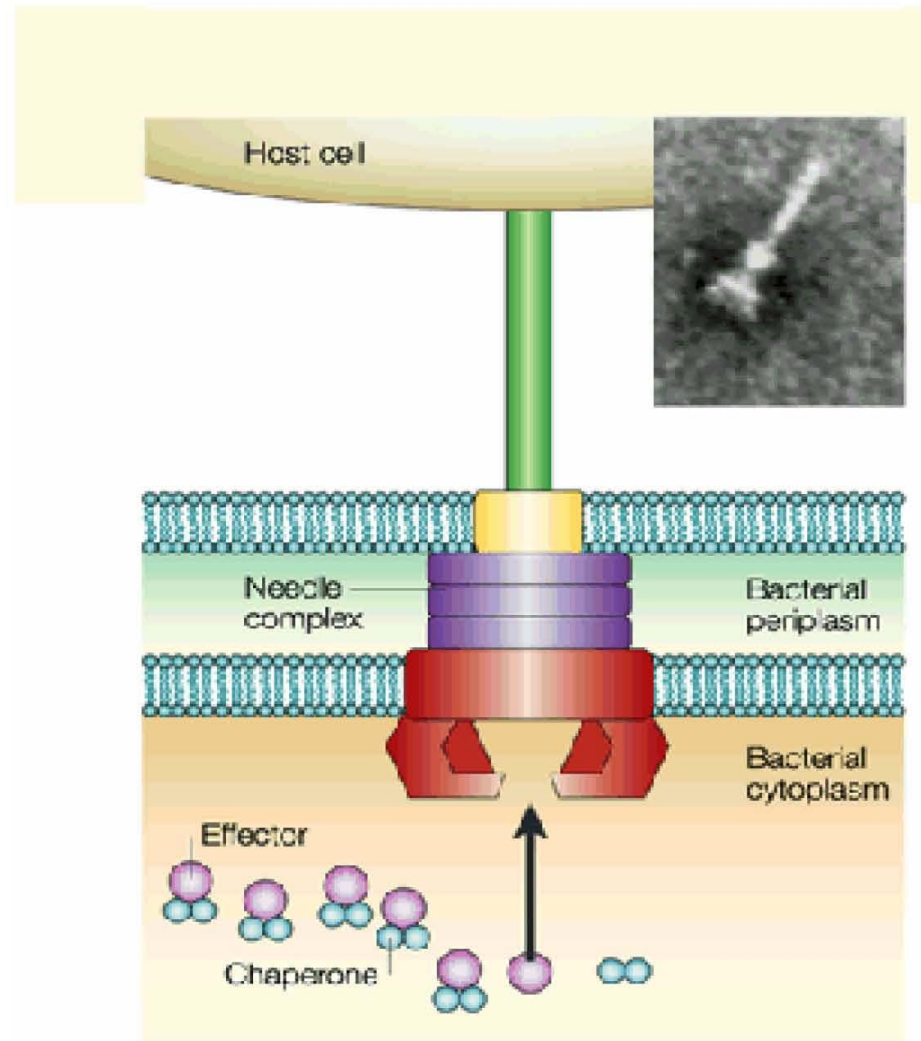
**Effectors, translocators, chaperones**



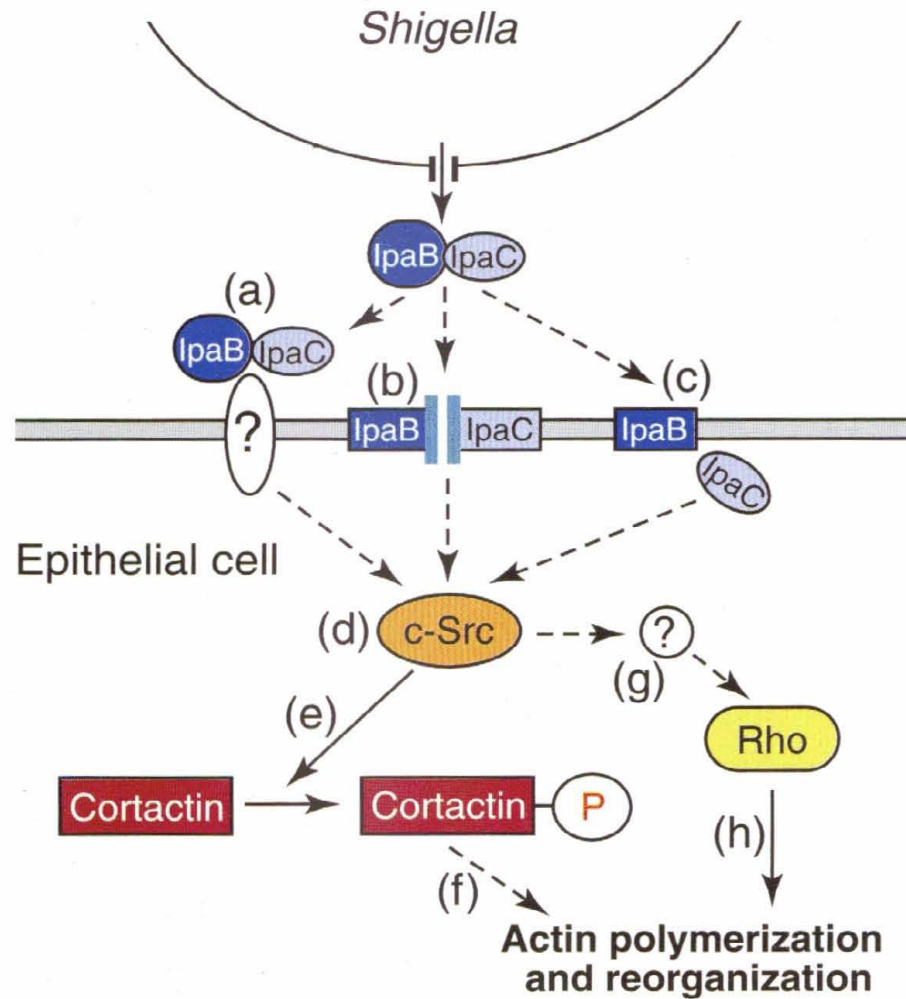
**Assembly & function of the T3SS needle complex**



Organizzazione sistema di secrezione di Tipo III: un sistema in grado di iniettare proteine dal batterio direttamente nella cellula bersaglio



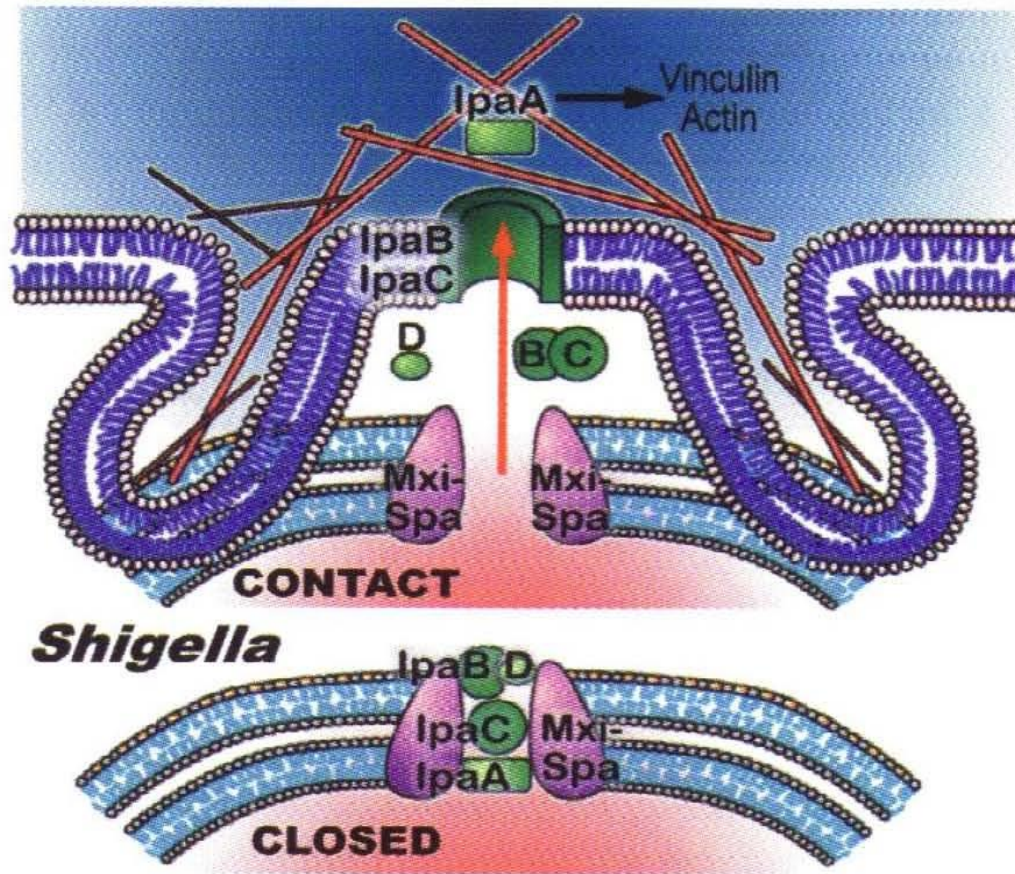
L'iniezione di IpaA nel citoplasma della cellula ospite altera profondamente il citoscheletro della cellula ospite



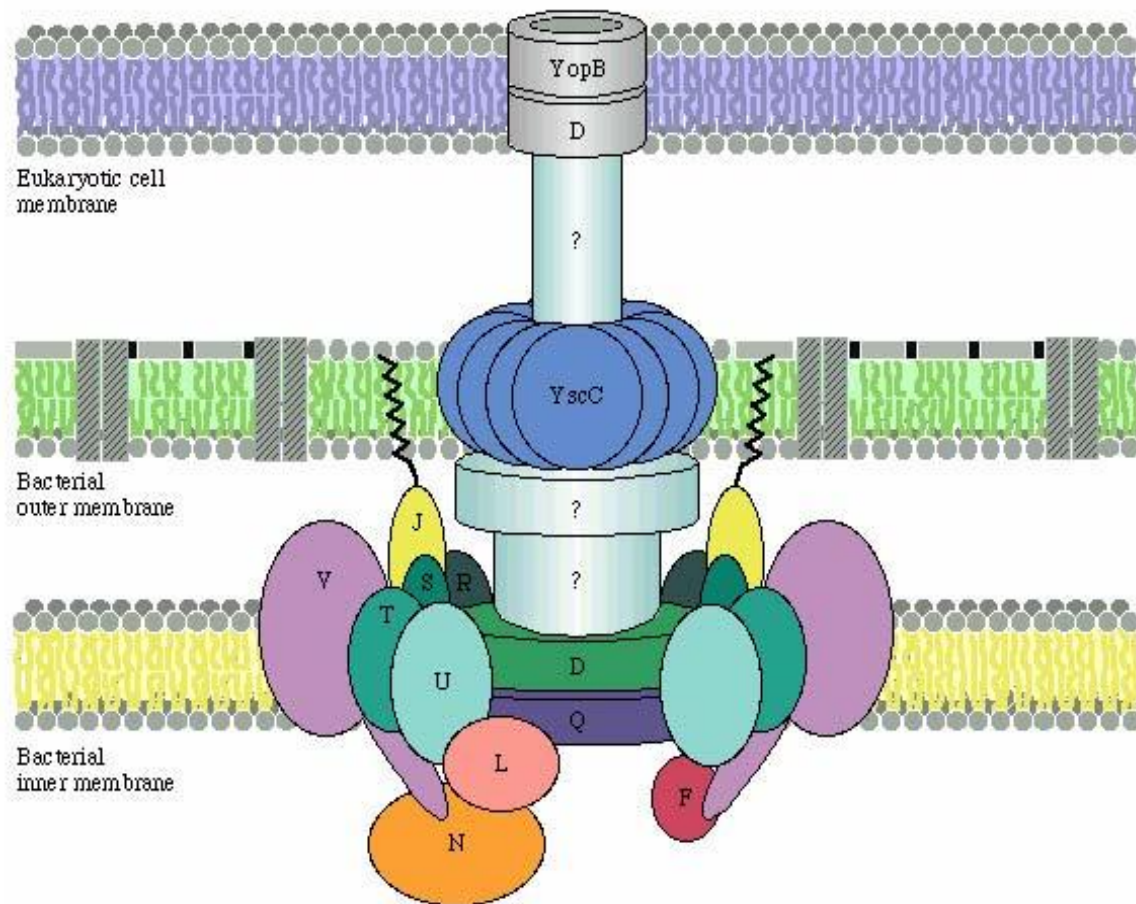
Il sistema di esportazione di tipo III viene attivato dal contatto della cellula batterica con la cellula bersaglio

Le proteine Mxi e Spa formano la struttura transmembranaria del sistema di esportazione

IpaB ed IpaC si inseriscono nella membrana della cellula bersaglio

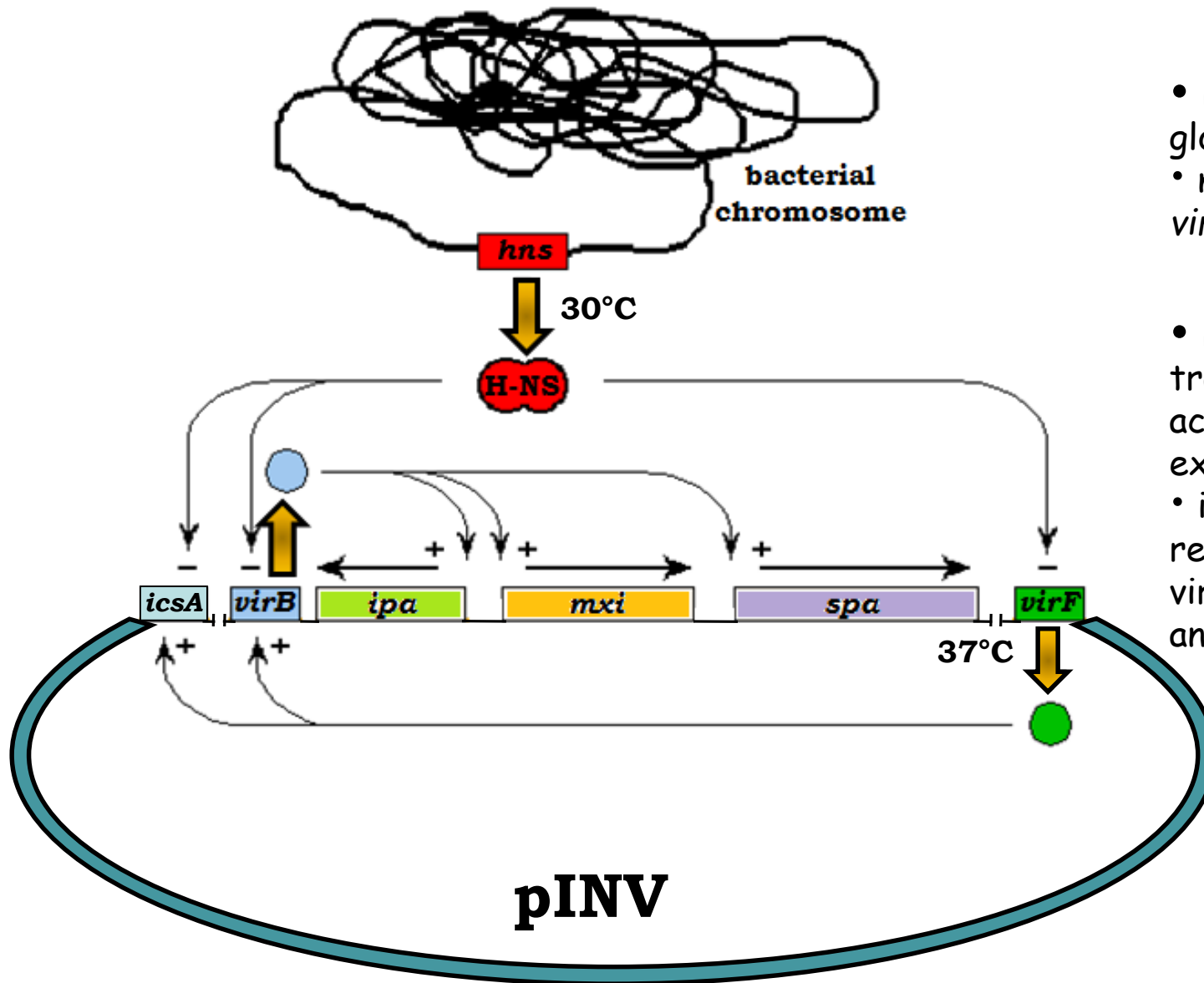


Il sistema di esportazione di Tipo III di *Yersinia* :  
elevata omologia con il TSS di *Shigella*





# Cross-talk between chromosomal and plasmid genes



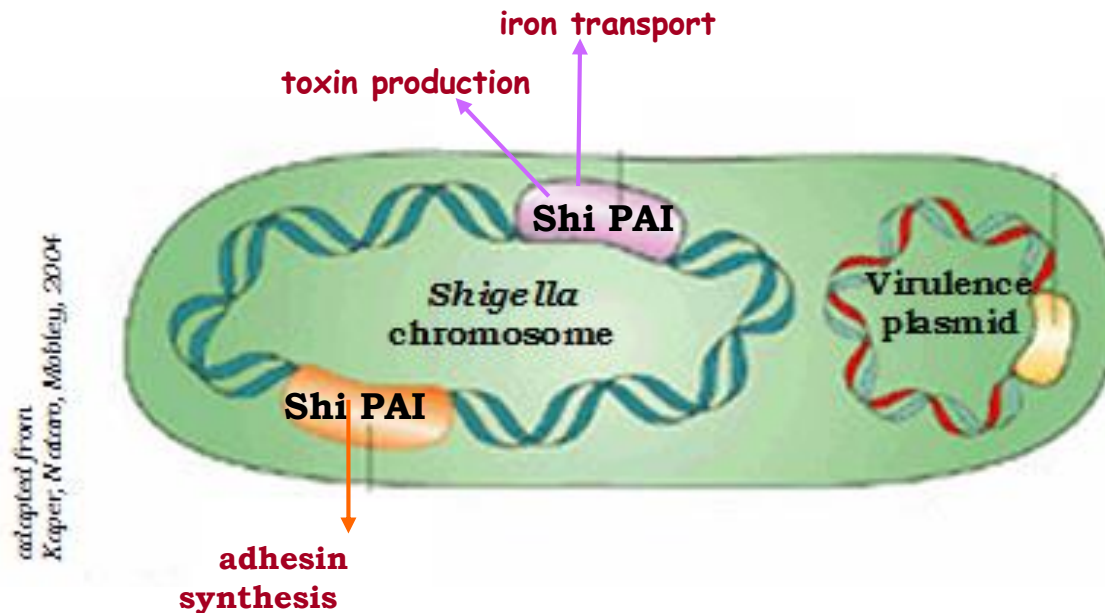
## H-NS

- is a chromosomal global regulator
- negatively regulates *virF* and *virB* at 30°C

## VirF

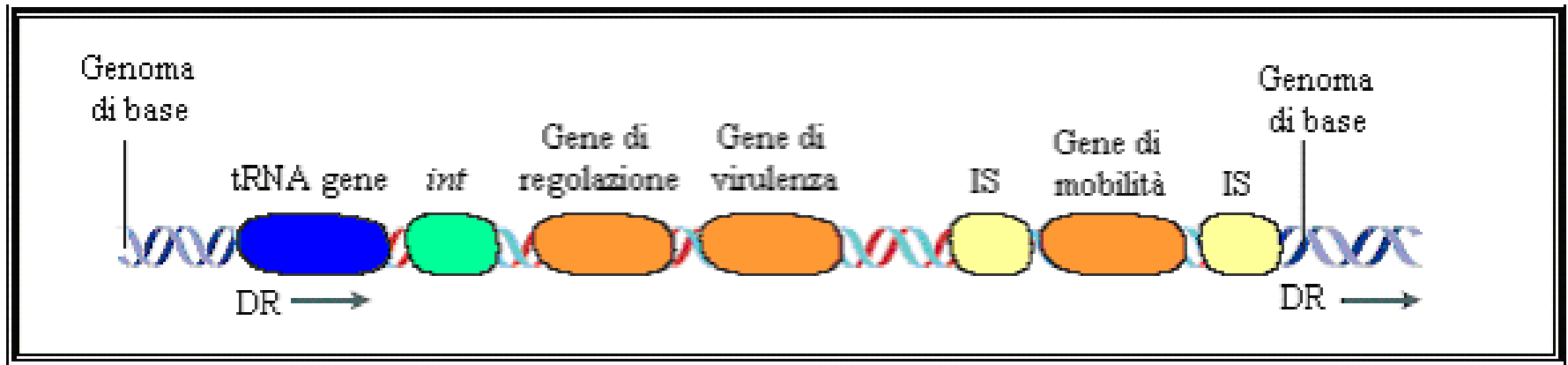
- is the first plasmid transcriptional activator of *Shigella* expressed at 37°C
- is able to positively regulate plasmid virulence genes, *virB* and *icsA*

Besides the acquisition of the large virulence plasmid pINV, several pathogenicity islands have been identified on the *Shigella* chromosome



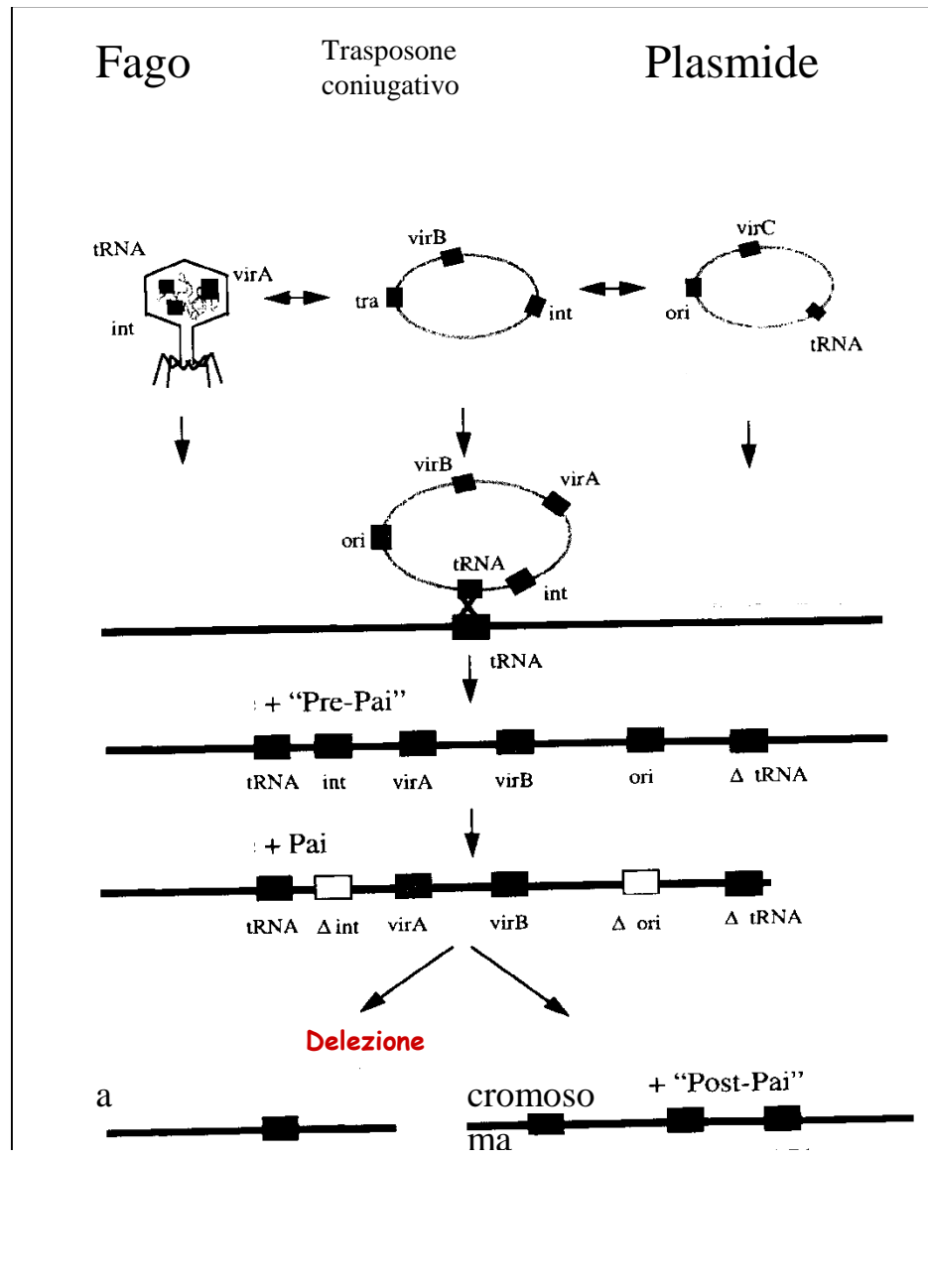
Shi PAIs carry genes that contribute to virulent life style

# ISOLE DI PATOGENICITA'



- Contengono uno o più geni di virulenza
- Sono presenti solo nei ceppi patogeni
- Sono di grandi dimensioni 10-200 kb
- Hanno un diverso contenuto in G+C (recente HTG)
- Sono spesso inserite in geni per tRNA
- Sono fiancheggiate da sequenze di DNA direttamente ripetute (DR)
- Sono associate a elementi genetici mobili
- Sono instabili
- Rappresentano strutture a mosaico

# Percorso evolutivo nell'origine di una PAI



Formazione di un cointegrato

Trasferimento orizzontale

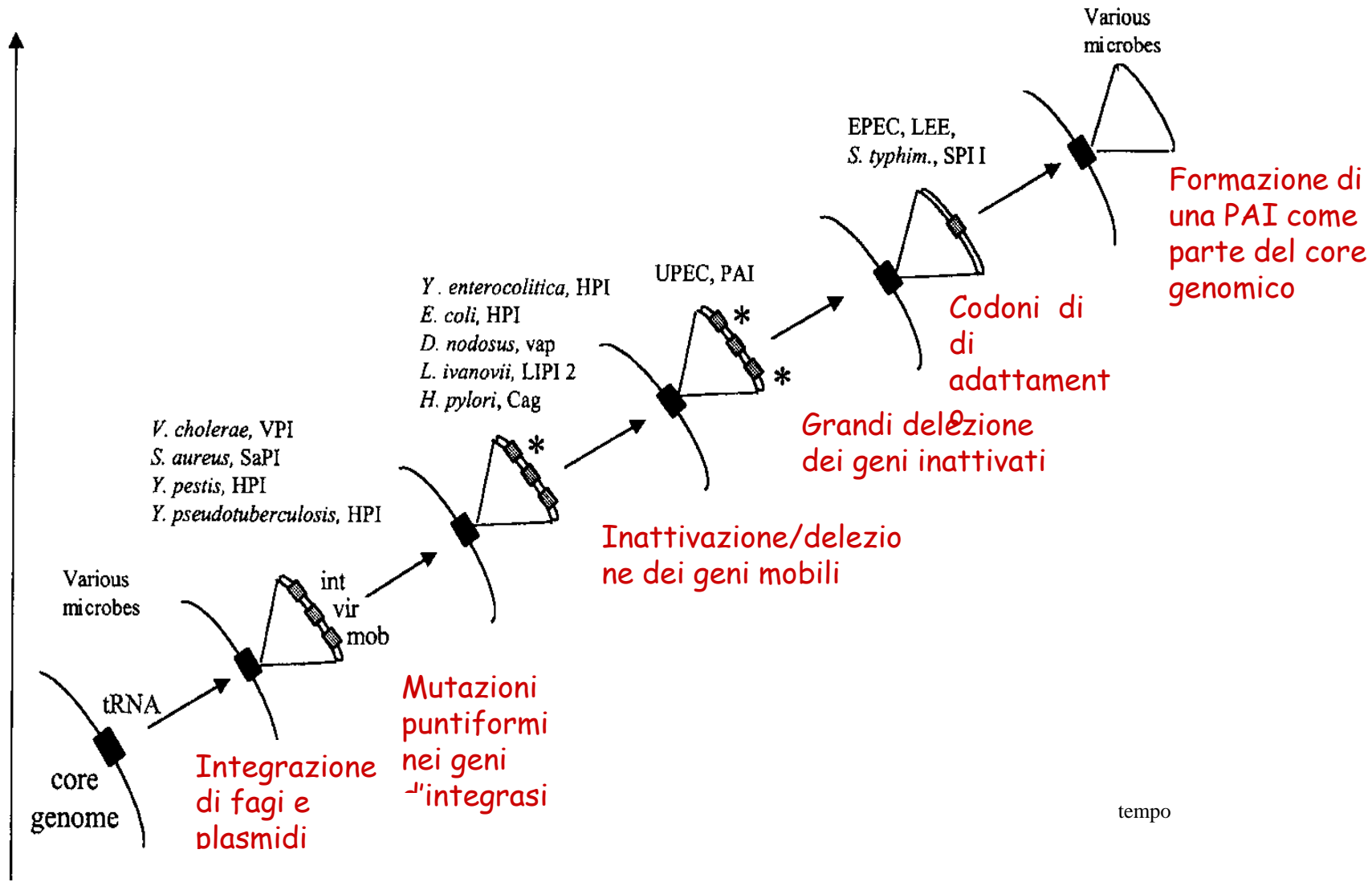
Ricombinazione

Integrazione

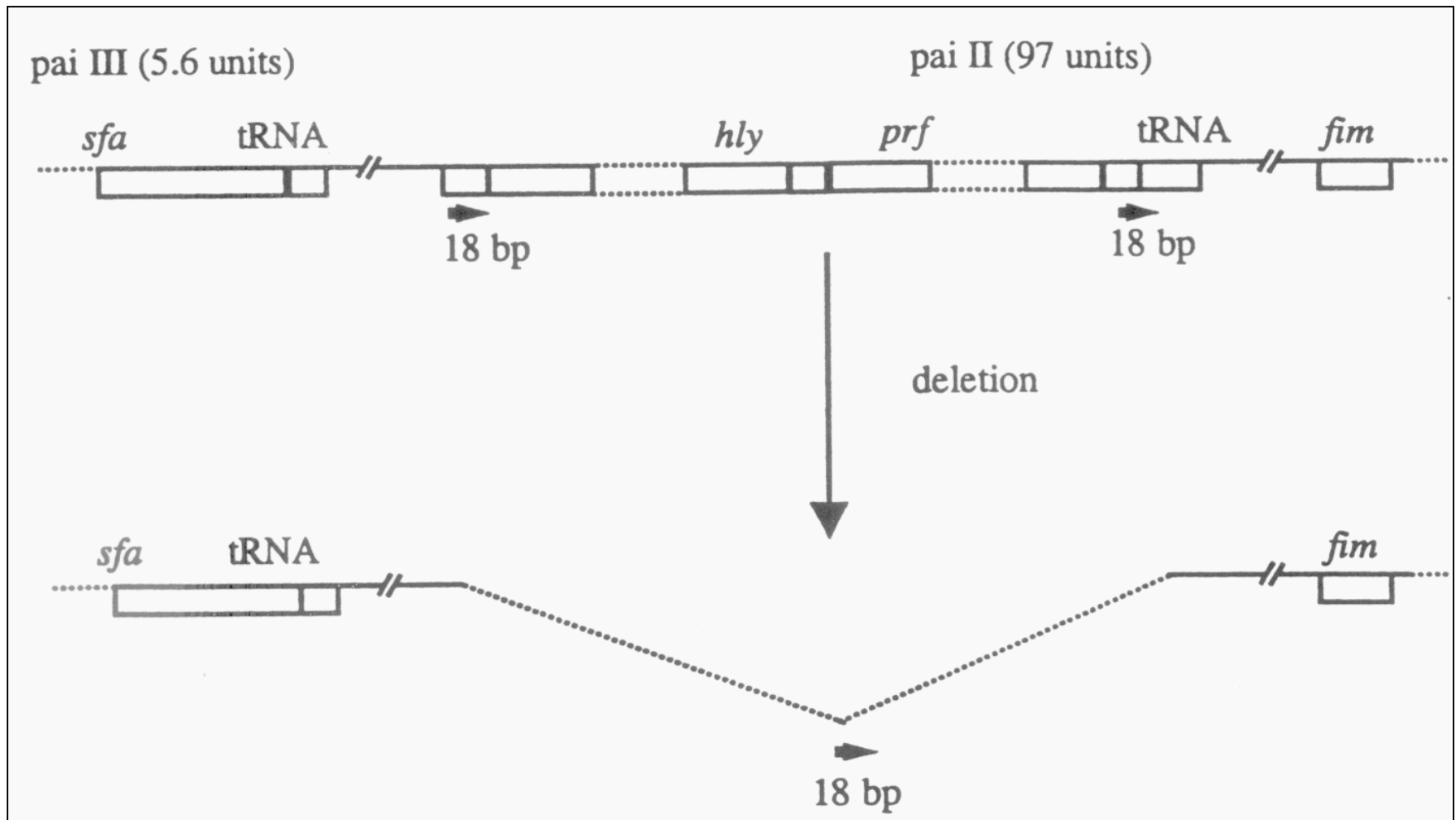
Mutazione, HOMING

Adattamento

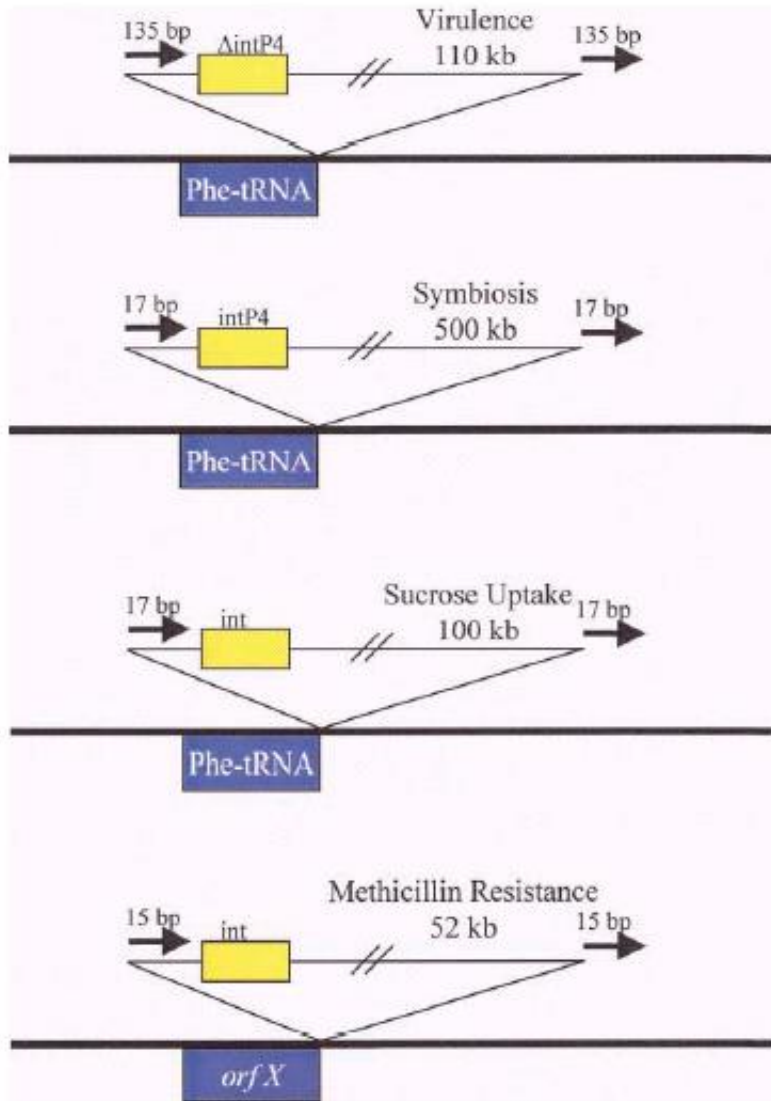
# Stadi evolutivi della formazione dell'isola di patogenicità



Le Isole di Patogenicità si possono excidere dal genoma attraverso ricombinazione tra le sequenze presenti nelle sequenze direttamente ripetute (DR)



Non soltanto Pathogenicity Island : il fenomeno coinvolge altri gruppi di geni → Genomic Island



Geni di virulenza

Pathogenicity island  
*Uropathogenic E.coli*

Geni per la simbiosi

Symbiosis Island  
*Mesorhizobium loti*

Geni per l'utilizzazione di zuccheri

Metabolic Island  
*Salmonella senftenberg*

Geni per la resistenza ad uno o più antibiotici

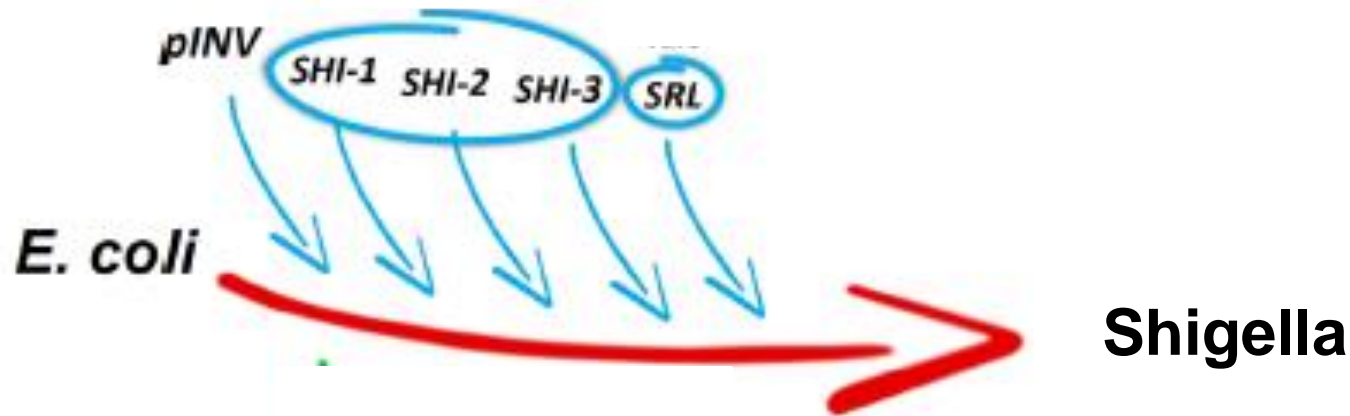
Resistance Island  
*Staphylococcus aureus*

# Caratteristiche generali delle Isole genomiche

- Sono regioni di DNA acquisite tramite HGT inserite nelle vicinanze dei **tRNA**.
- Sono fiancheggiate da **DR**
- Contengono diversi geni coinvolti nel processo di adattamento
- Contengono elementi IS funzionali o difettivi
- contiene geni legati alla motilità
- Ruolo fondamentale svolto dal gene **INT** che codifica per l'**INTEGRASI** coinvolta nell'inserzione e delezione di regioni di DNA fiancheggiate da DR



## Ruolo delle Isole di patogenicità



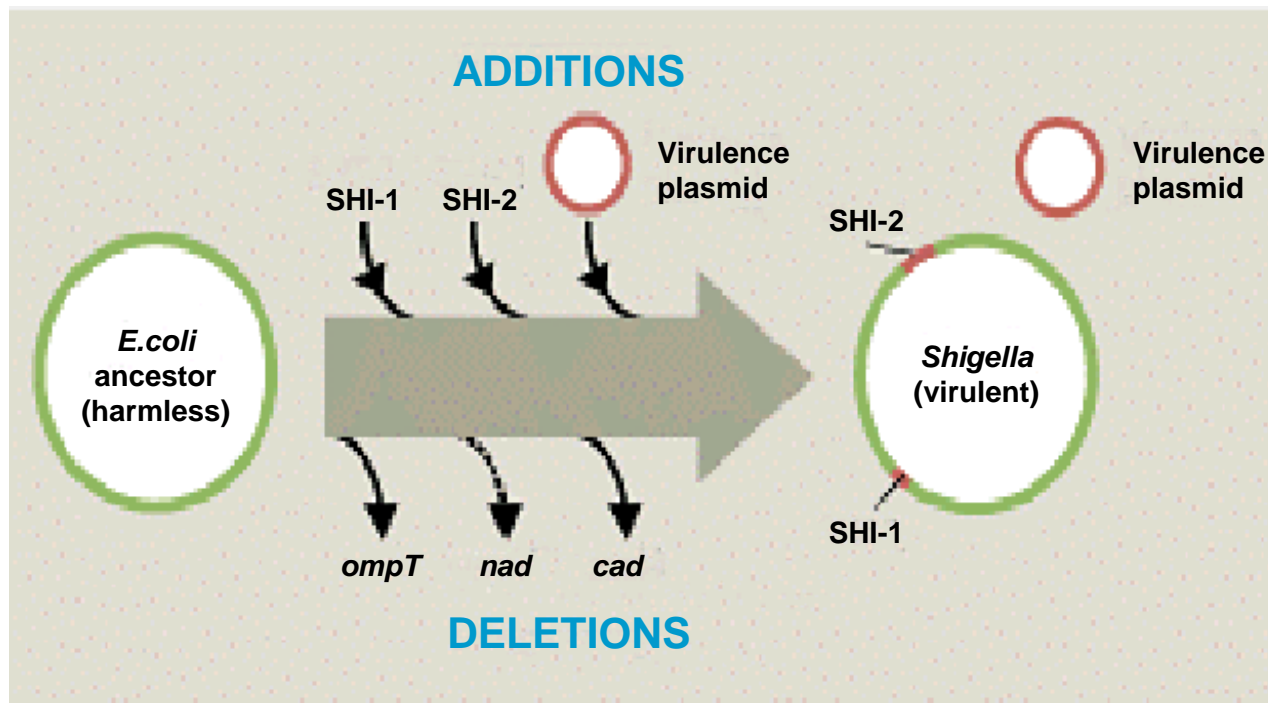
SHI-1: codifica per enterotossina e una proteasi citotossica

SHI-2 e SHI-3: per un sistema di cattura del ferro e sistema di evasione

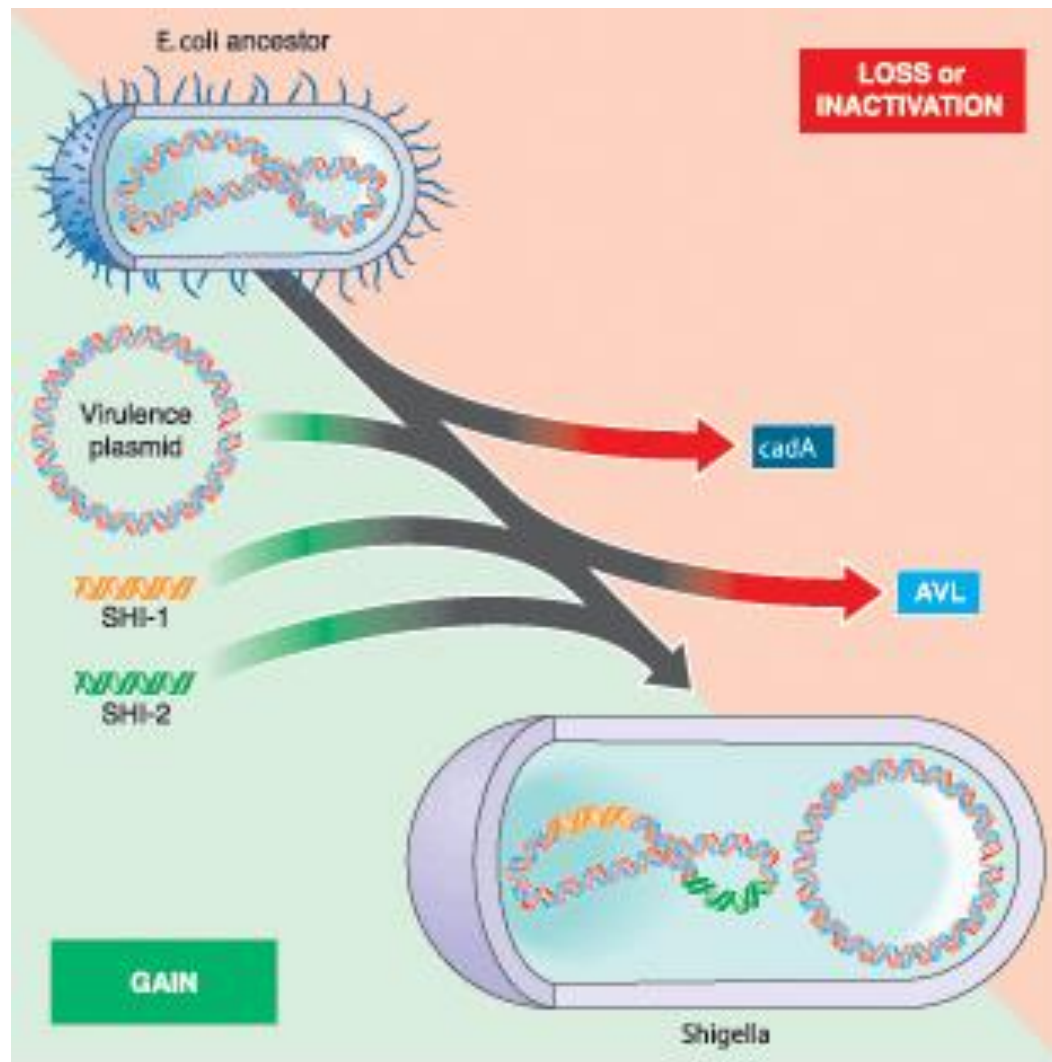
SHI-O: modificazione dell'antigene O ( geni fagici)

SRL : resistenza multipla

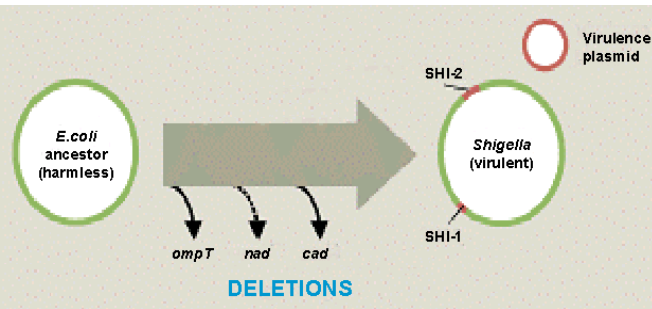
# Shedding of genes which interfere with the pathogenic lifestyle *Shigella*



In *Shigella* gene acquisition by horizontal gene transfer is counterbalanced by the loss of native genes, which may have become unnecessary or deleterious for intracellular life.



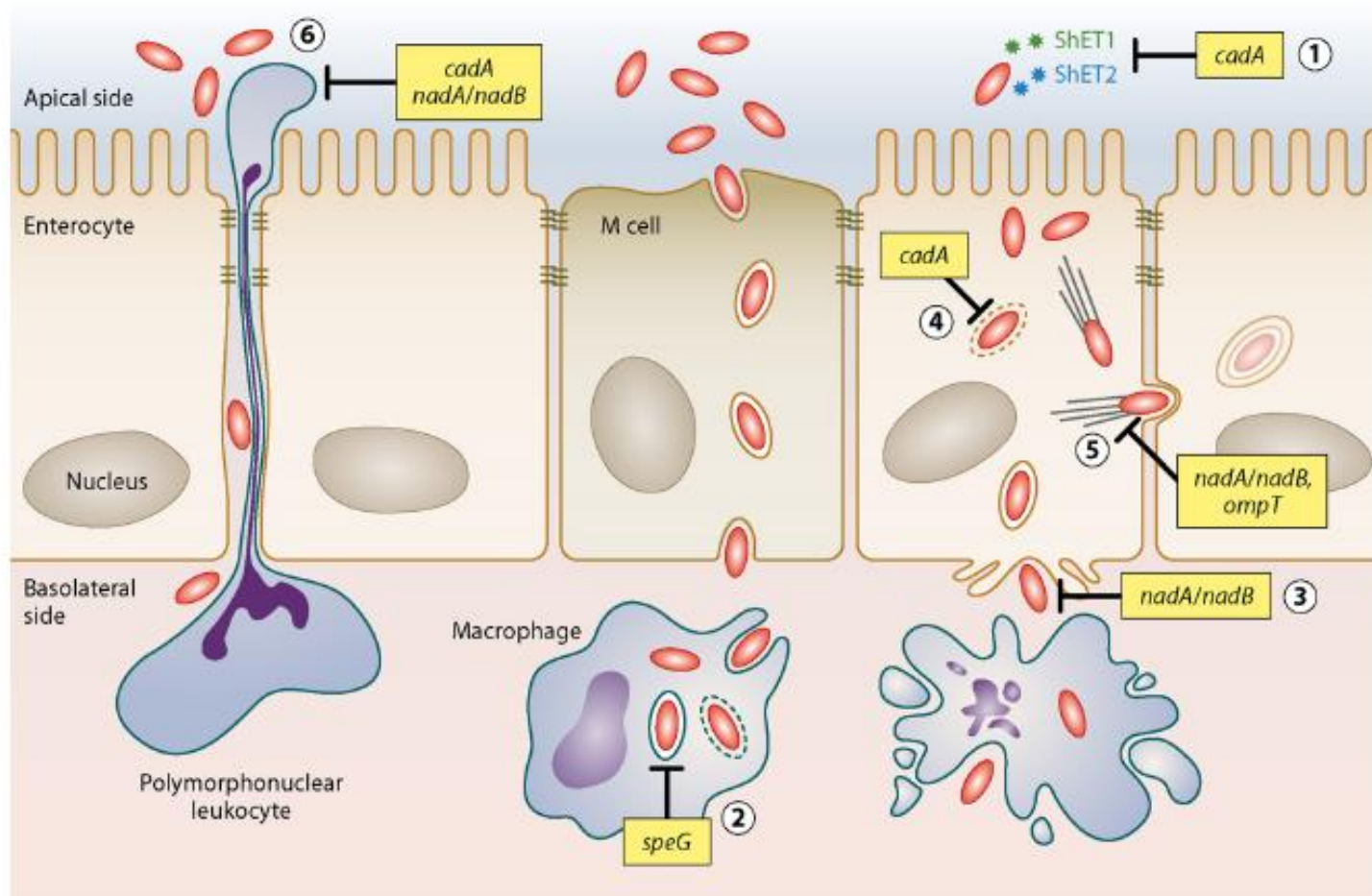
# Antivirulence genes are eliminated through pathoadaptive mutations



## Patho(genicity) adaptive mutations

- improve bacterial fitness in new host environments
- drive a microorganism towards a more pathogenic lifestyle
- Some examples pathoadaptive mutations in *Shigella*:
  - loss of cadaverine
  - Loss of acetylspermidine
  - Loss of surface protease OmpT
  - Loss of ability to synthesize nicotinic acid (QUINOLATE)

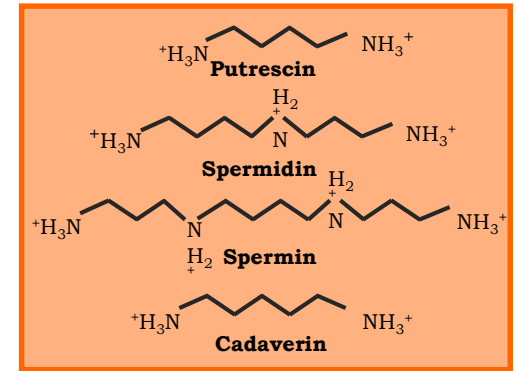
# Effect of antivirulence genes of *Shigella* on the invasive process.



Two genetic loci involved in the synthesis of polyamines have been silenced...

# Basic functional role of polyamines

Polyamines are small polycationic molecules present in both, eucaryotic and prokaryotic cells..



They stabilize the plasma membrane and control its permeability

They are involved in response to acid and oxidative stress

They are involved in several processes due to their ability to bind nucleic acids.

A major role is played also in the biosynthesis of proteins:

Polyamines bind to RNA favouring the assembly of the 30S subunit and increasing the fidelity of the translation process

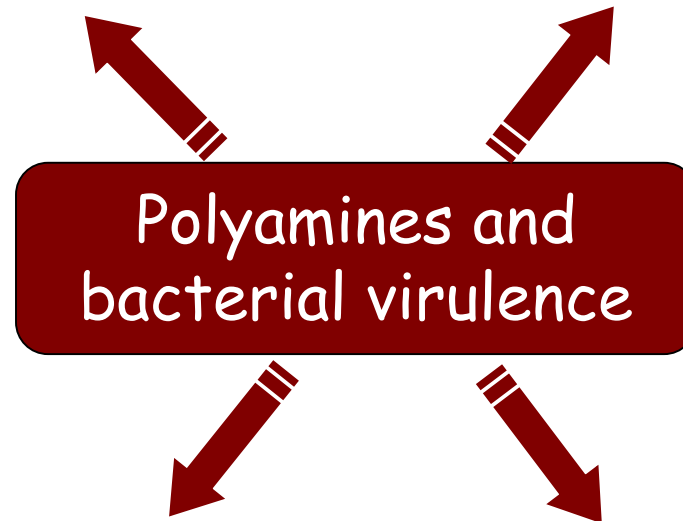
Polyamines exert also a more target-specific action: they affect the translation of several genes, including a number of global regulators, by facilitating the formation of the translation initiation complex

## BIOFILM FORMATION

*Yersina pestis*  
*Vibrio cholerae*  
*Burkholderia pseudomallei*

## EXPRESSION OF VIRULENCE

*Streptococcus pneumoniae*  
*Shigella/EIEC* pathotype



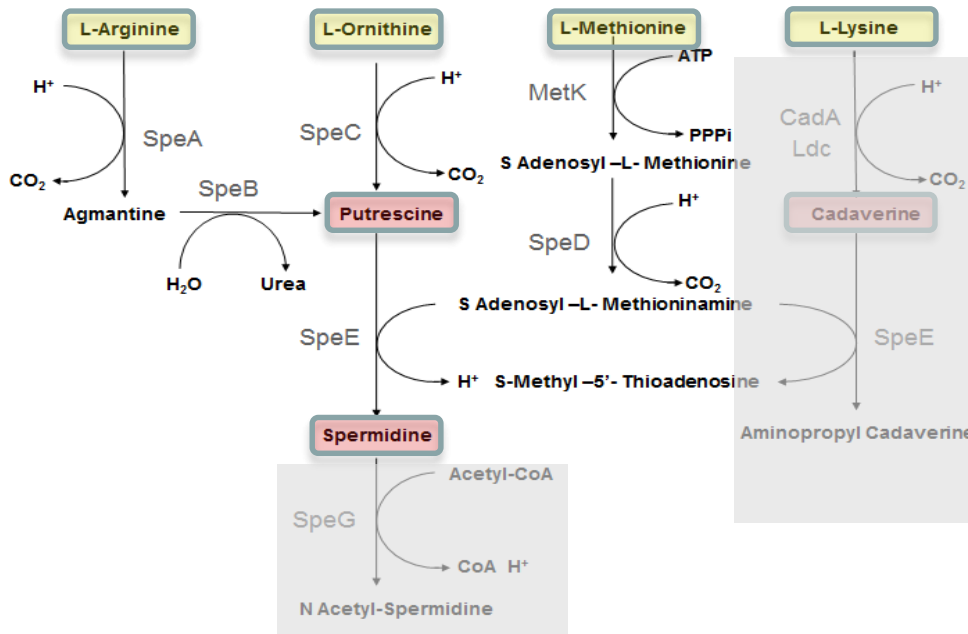
## EXPLOITATION OF HOST CELL POLYAMINES

- *Helicobacter pylori*  
macrophage apoptosis, DNA damages
- Legionella pneumophila*  
bacterial intracellular growth
- *Francisella tularensis*  
disruption of the innate immunity response

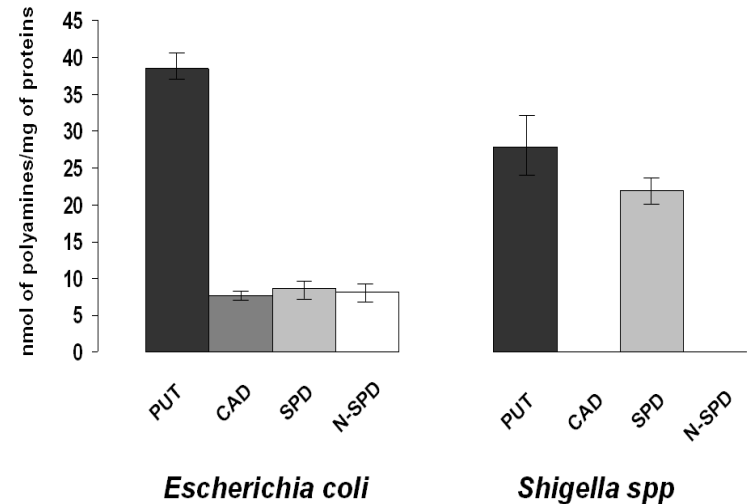
## EXPRESSION of T3SS

*Salmonella Typhimurium* ( $SP_1SP_2$ )  
*Pseudomonas aeruginosa* (*exsCEBA*)

# Comparison of the polyamine biosynthesis pathways in *E. coli* and *Shigella* reveals strong differences



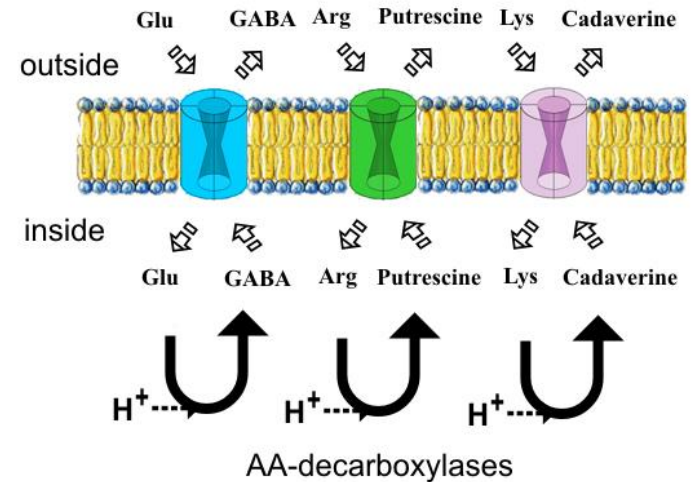
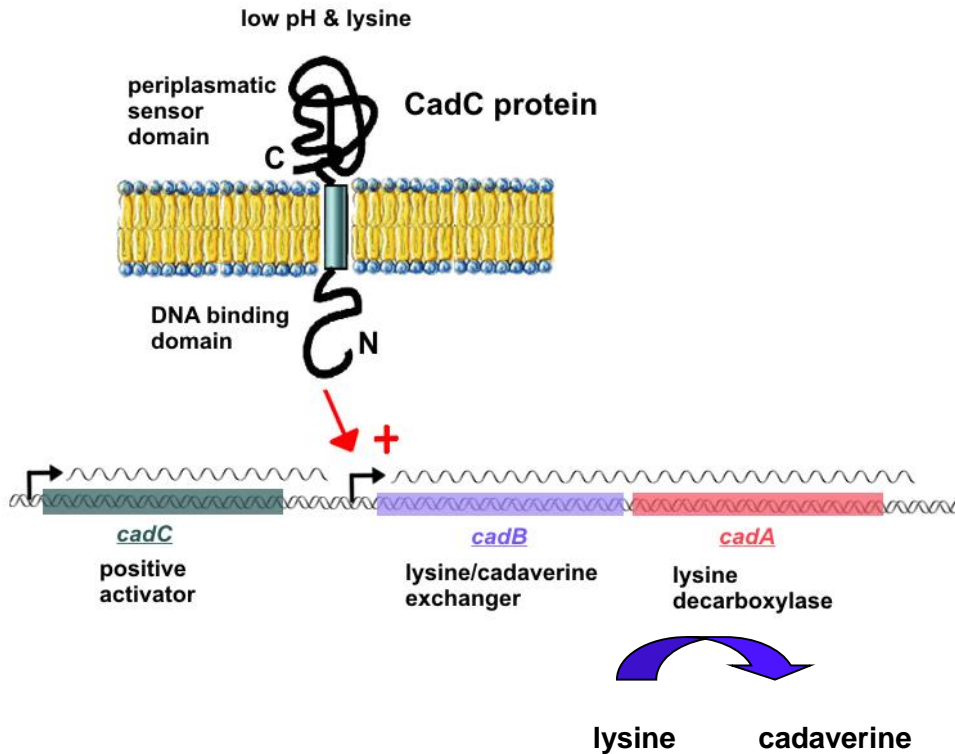
Cadaverine and acetylspermidine are lost while spermidine accumulates



How do the changes in the polyamine pattern influence the *Shigella* invasive process?

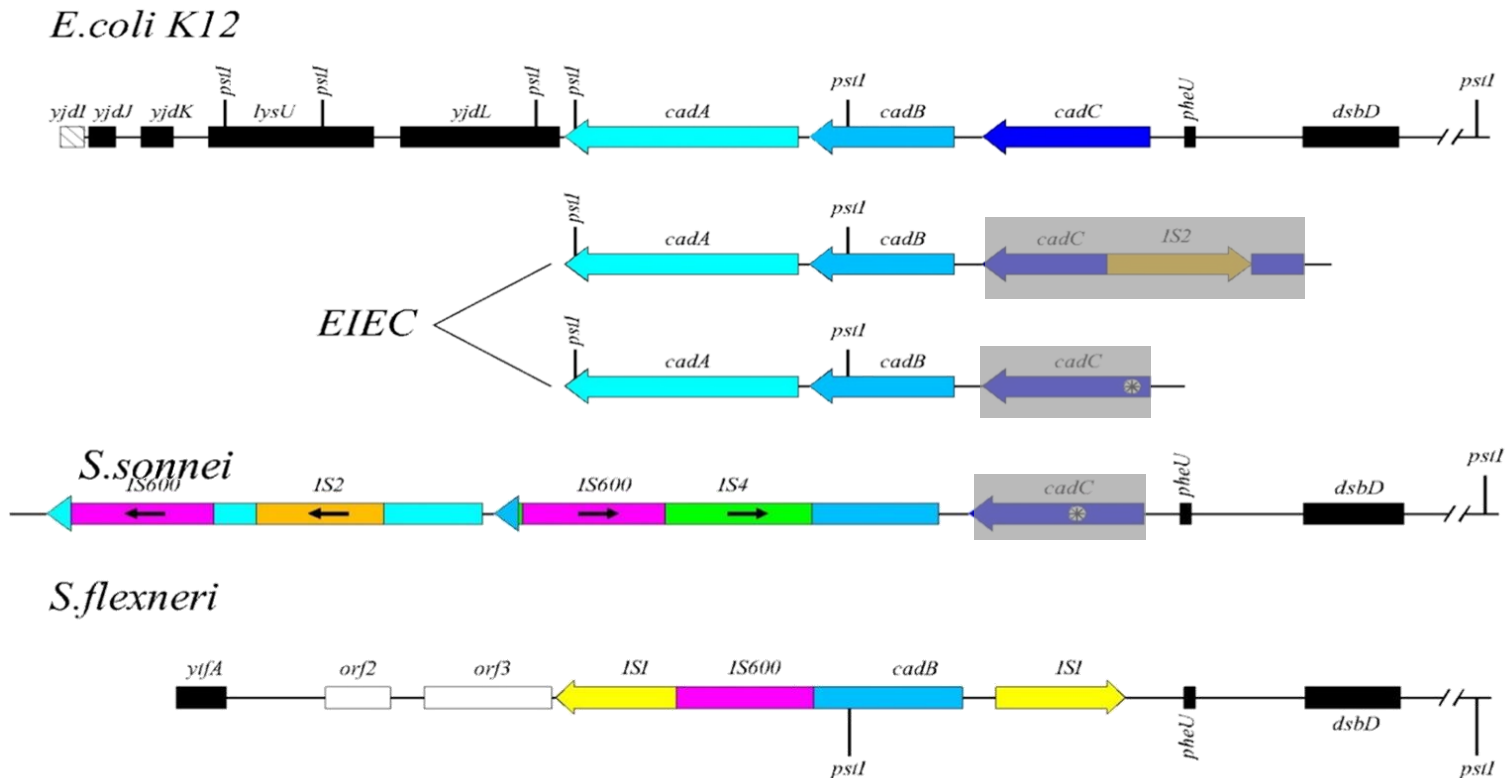


# Through lysine decarboxylation at low pH CadA synthesizes cadaverine, a small polyamine



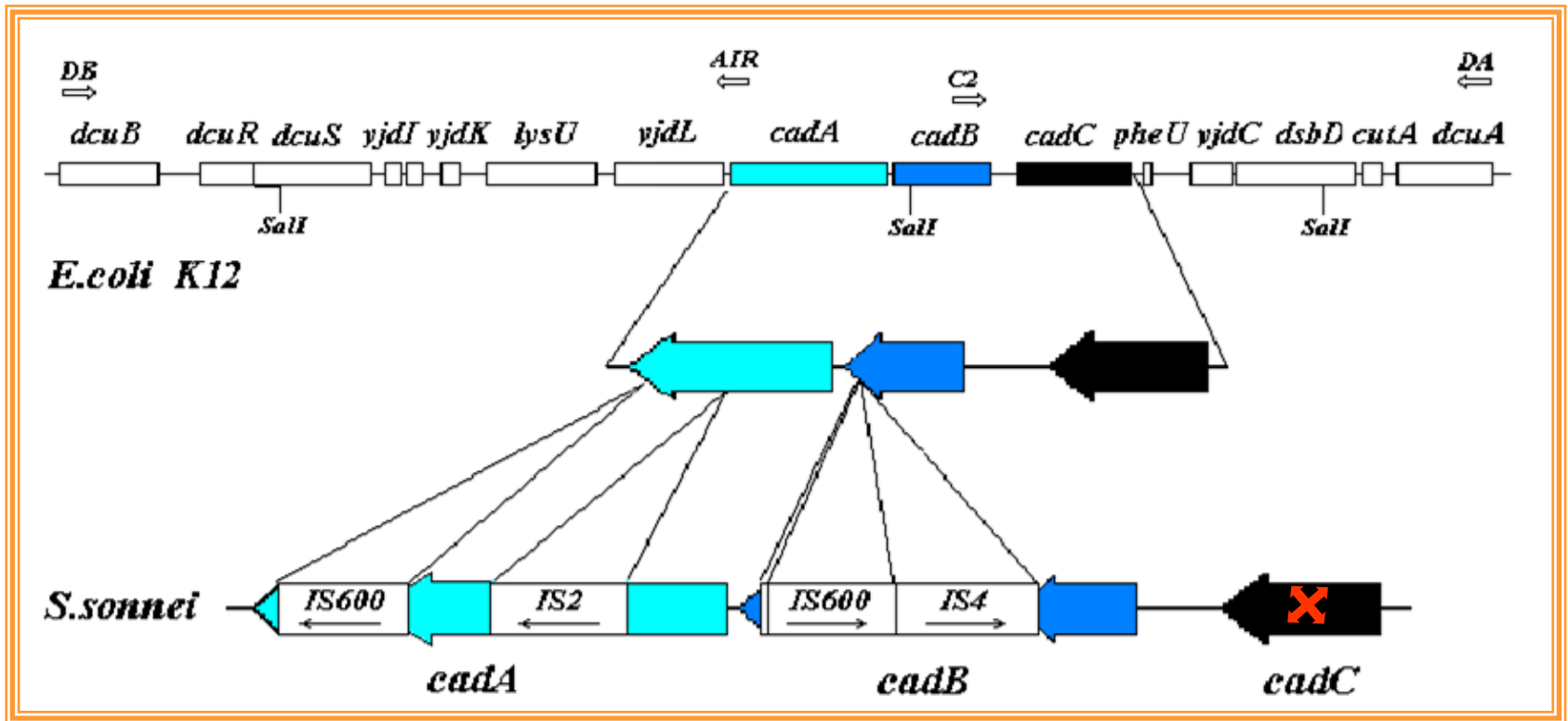
At low pH the release of cadaverine protects the cell from acidification

# In *Shigella* /EIEC the lack of cadaverine synthesis is obtained through a convergent evolution



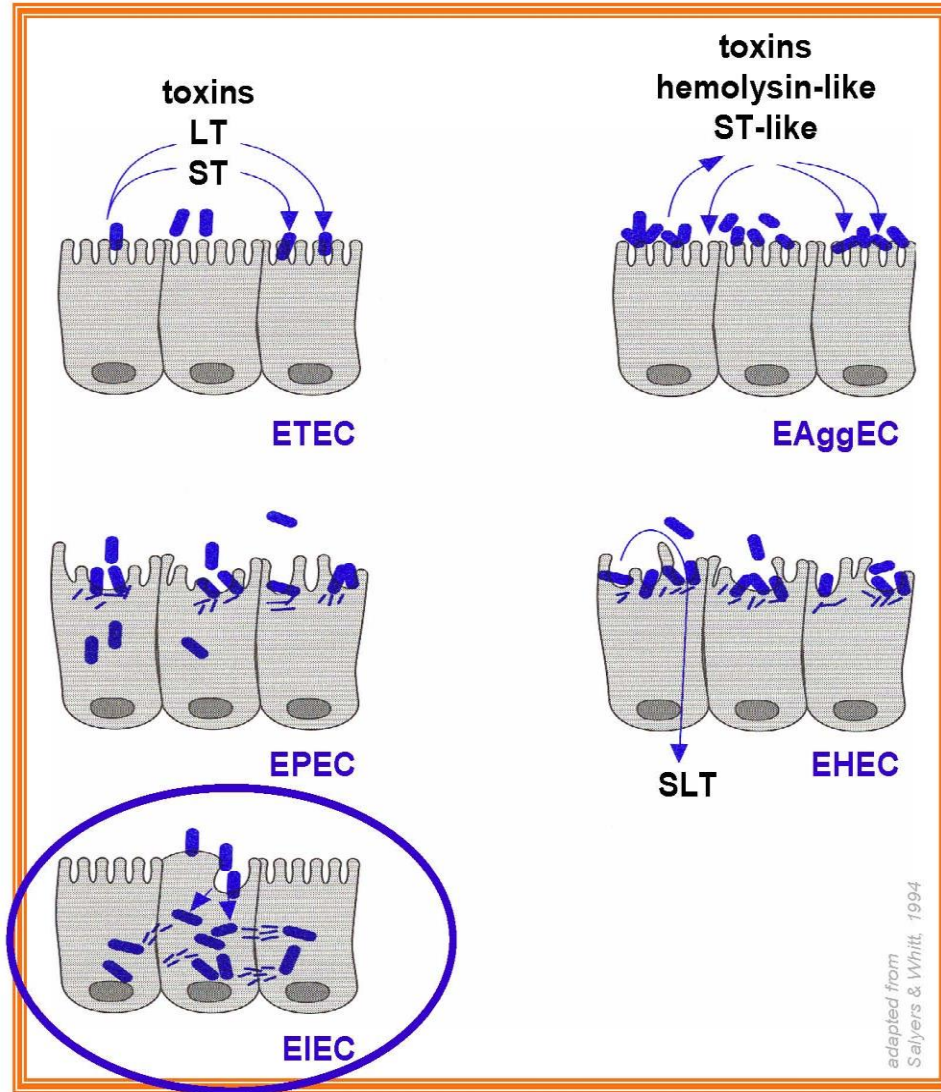
Convergent evolution : different strategies , one goal  
 but....the *cadC* regulatory gene is the preferential target of convergent evolution toward  
 the LCD- phenotype

# *Shigella sonnei* is a new emergent pathogen, often associated with shigellosis in industrial countries



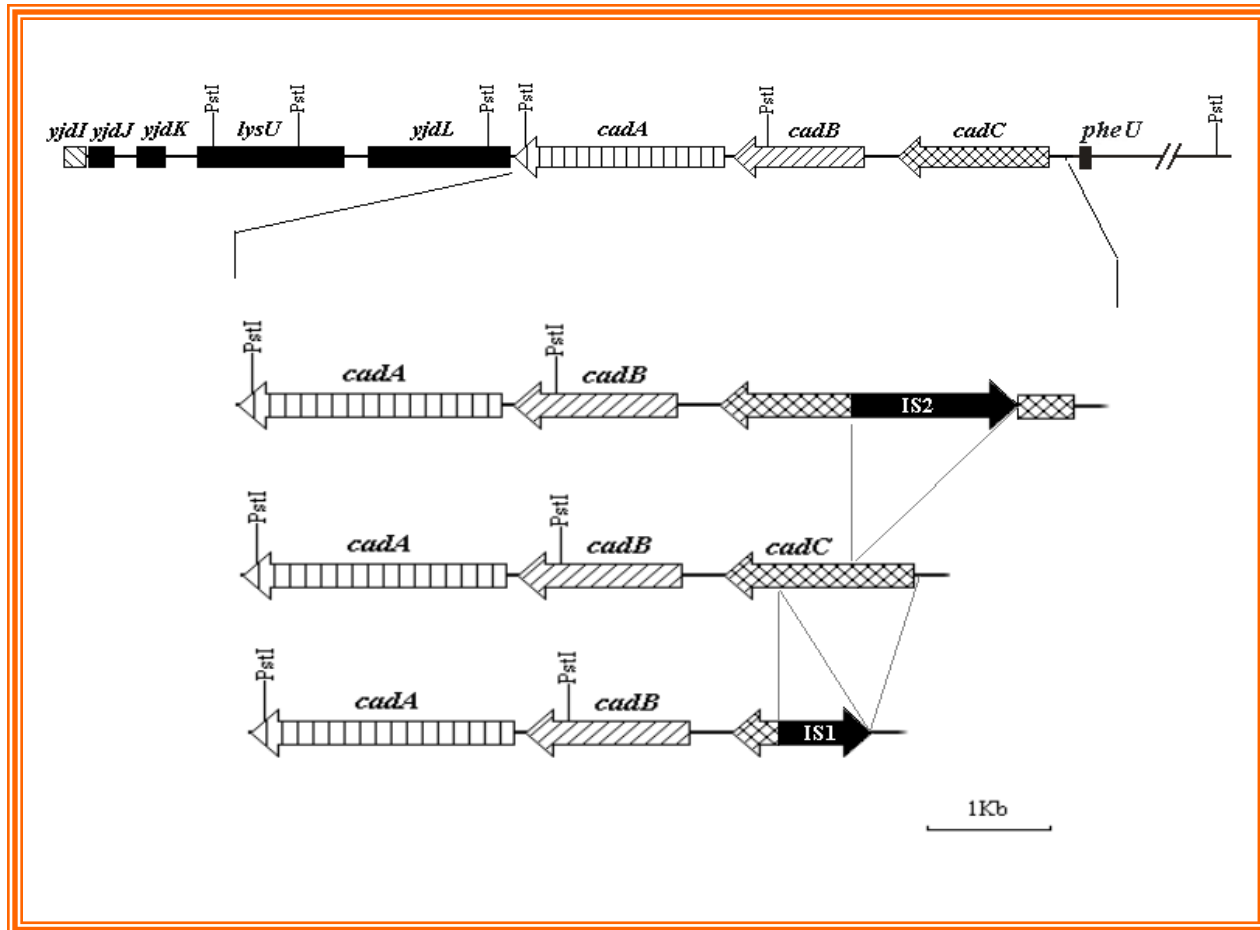
IS sequences have inactivated the *cadBA* genes without inducing deletions. Colinearity with the *E. coli* K12 chromosome is maintained.

Among *E.coli* strains causing intestinal disease  
all EIEC are unable to synthesize cadaverine



EIEC strains share with *Shigella* the same pathogenicity process, but they exhibit a higher metabolic activity since they retain the ability to catabolize substrates widely used by *E.coli*

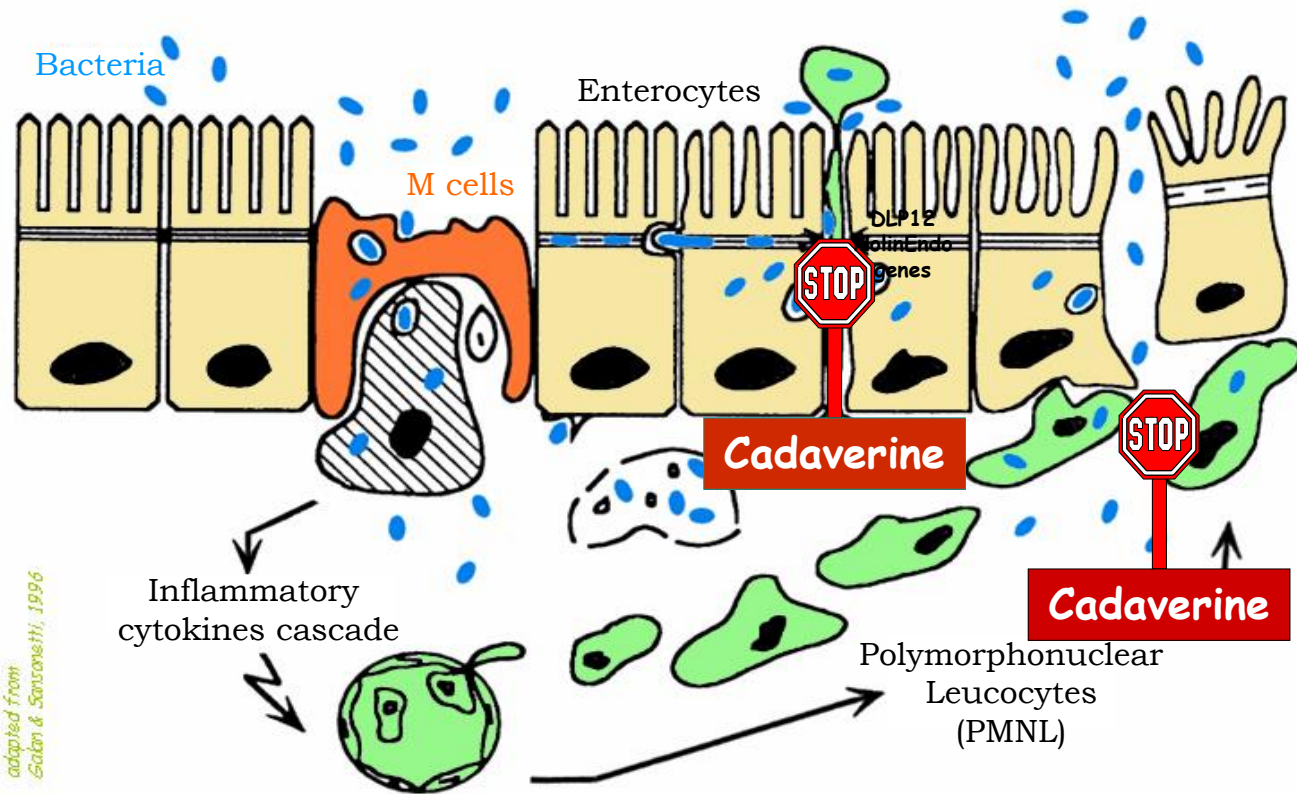
# Lack of cadaverine activity in *E.coli* EIEC is induced by IS sequence insertions into the regulatory gene *cadC*



Silencing of the *cadC* gene is obtained by different strategies: in one strain a single point mutation in the promoter region abolishes *cadC* expression



# Why is the loss of cadaverine a pathoadaptative mutation?



The *Shigella* invasive process is attenuated by cadaverine through:

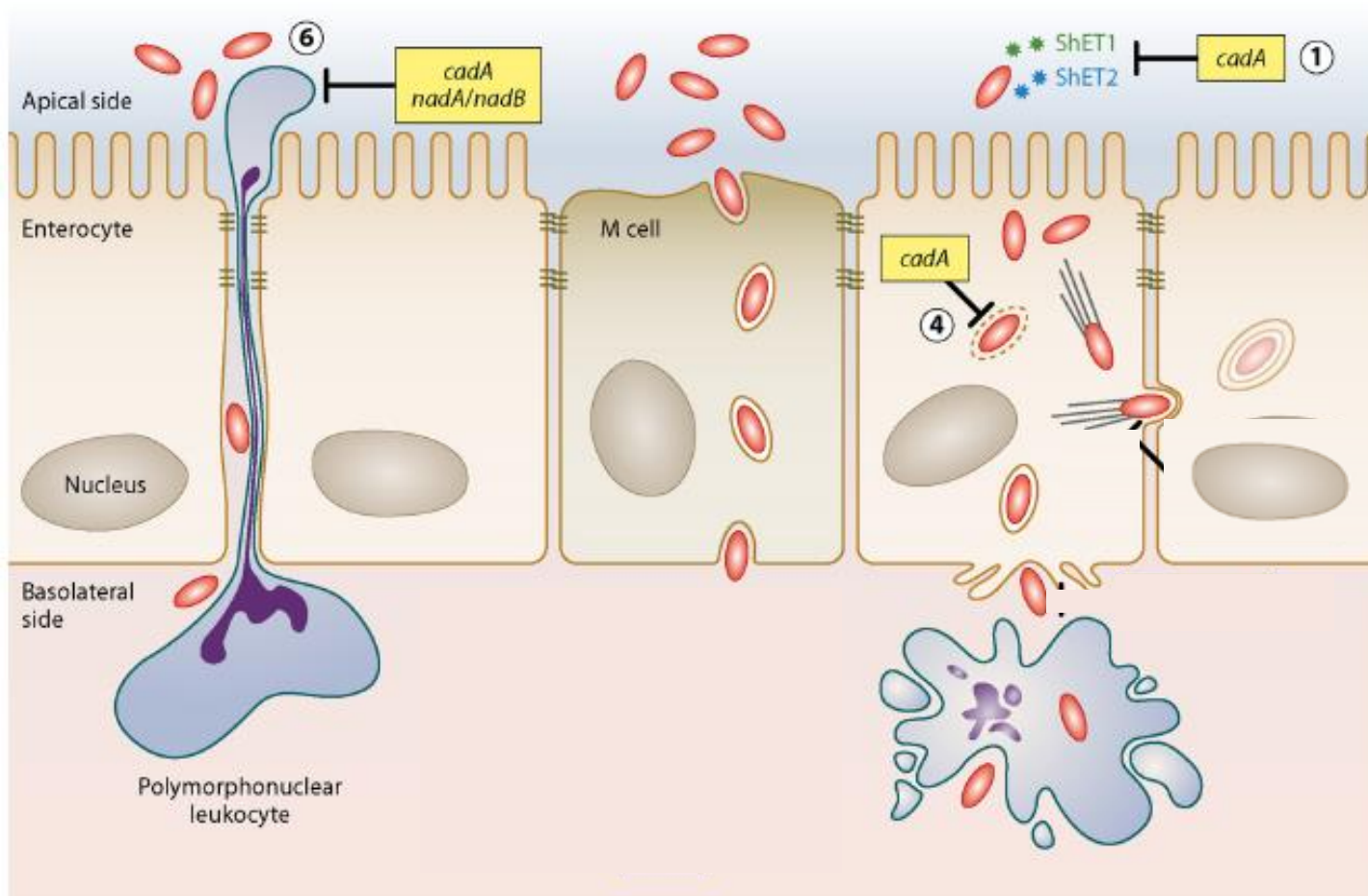
retarding the lysis of *Shigella*-containing vacuoles

decreasing the ability of PMNL to transmigrate

inhibiting ShEt1 and ShEt2 enterotoxin activity

## Cadaverine induces:

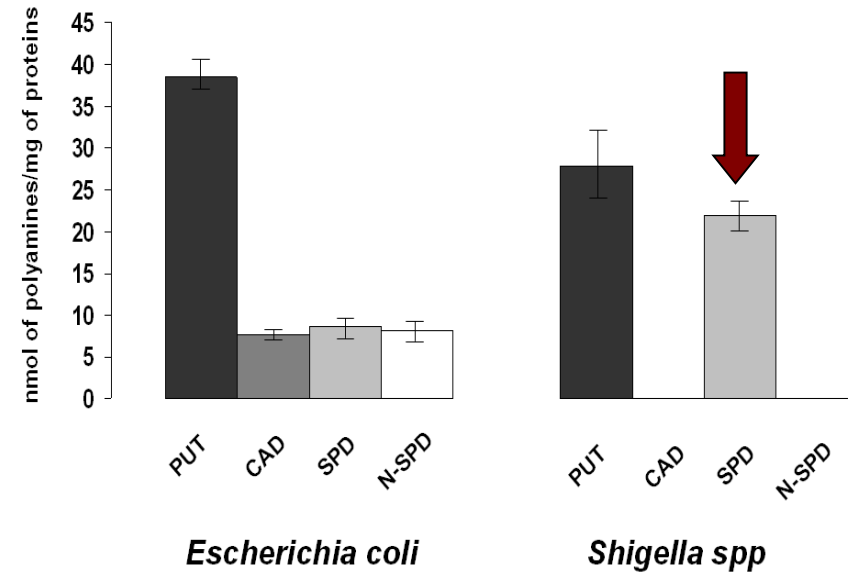
- Endosomal membrane stabilization
- Inhibition of PMN's migration
- Reduction of enterotoxicity





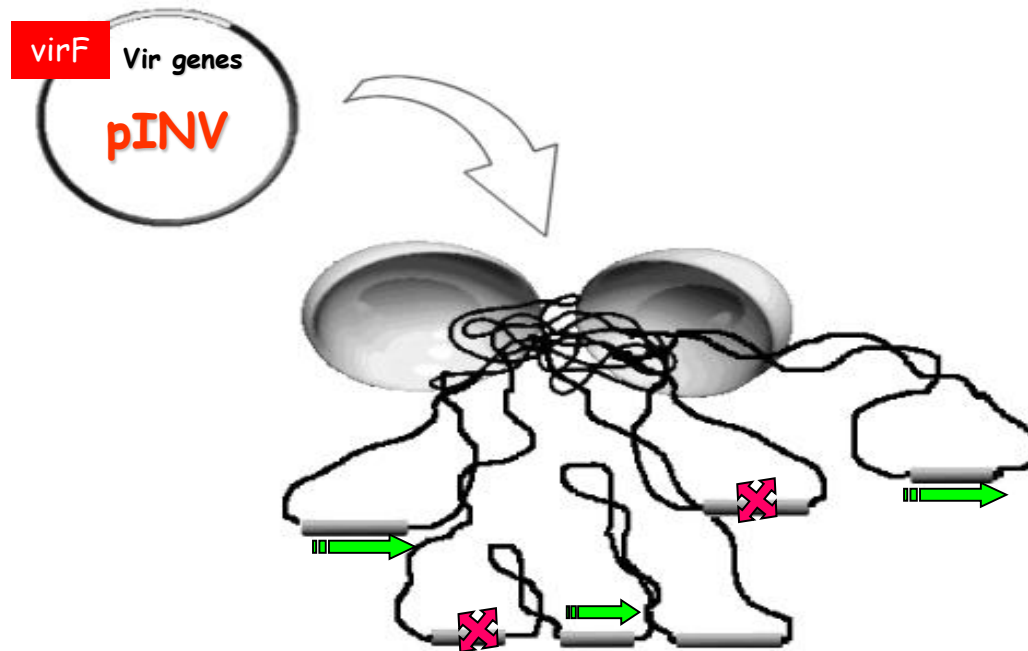
# Spermidine accumulation in *Shigella* : a consequence of the acquisition of the VirF regulator?

Besides the loss of cadaverine, the polyamine profile of *Shigella* is characterized by the accumulation of spermidine.



Cadaverine and acetylspermidine are lost while spermidine accumulates

What changes in the transcription profile have been induced by the acquisition of the plasmid-encoded regulatory factor VirF?



# *E. coli* K12 transcriptome analysis in the presence/absence of VirF shows that VirF-regulated genes can be grouped into...

... genes up-regulated by VirF and conserved in *Shigella* ...

<i>Gene</i>	VirF induction (x-fold)	Description
<i>htpG</i>	10.9	Heat shock chaperone
<i>trpA</i>	7.1	Tryptophan synthase
<i>groS</i>	6.2	GroESL small subunit
<i>groL</i>	6.1	GroESL large subunit
<i>bfr</i>	5.8	Bacterioferritin
<i>prmB</i>	4.8	glutamine methyltransferase
<i>sucA</i>	4.5	2-oxoglutarate dehydrogenase
<i>trpS</i>	3,5	Tryptophan-tRNA ligase
<i>ung</i>	3,2	Uracil-DNA glycosylase
<i>carA</i>	3,1	Carbamoylphosphate synthase
<i>agp</i>	3.1	Periplasmic glucose-1-phosphatase

... and genes up-regulated by VirF  
and silenced in *Shigella* ...

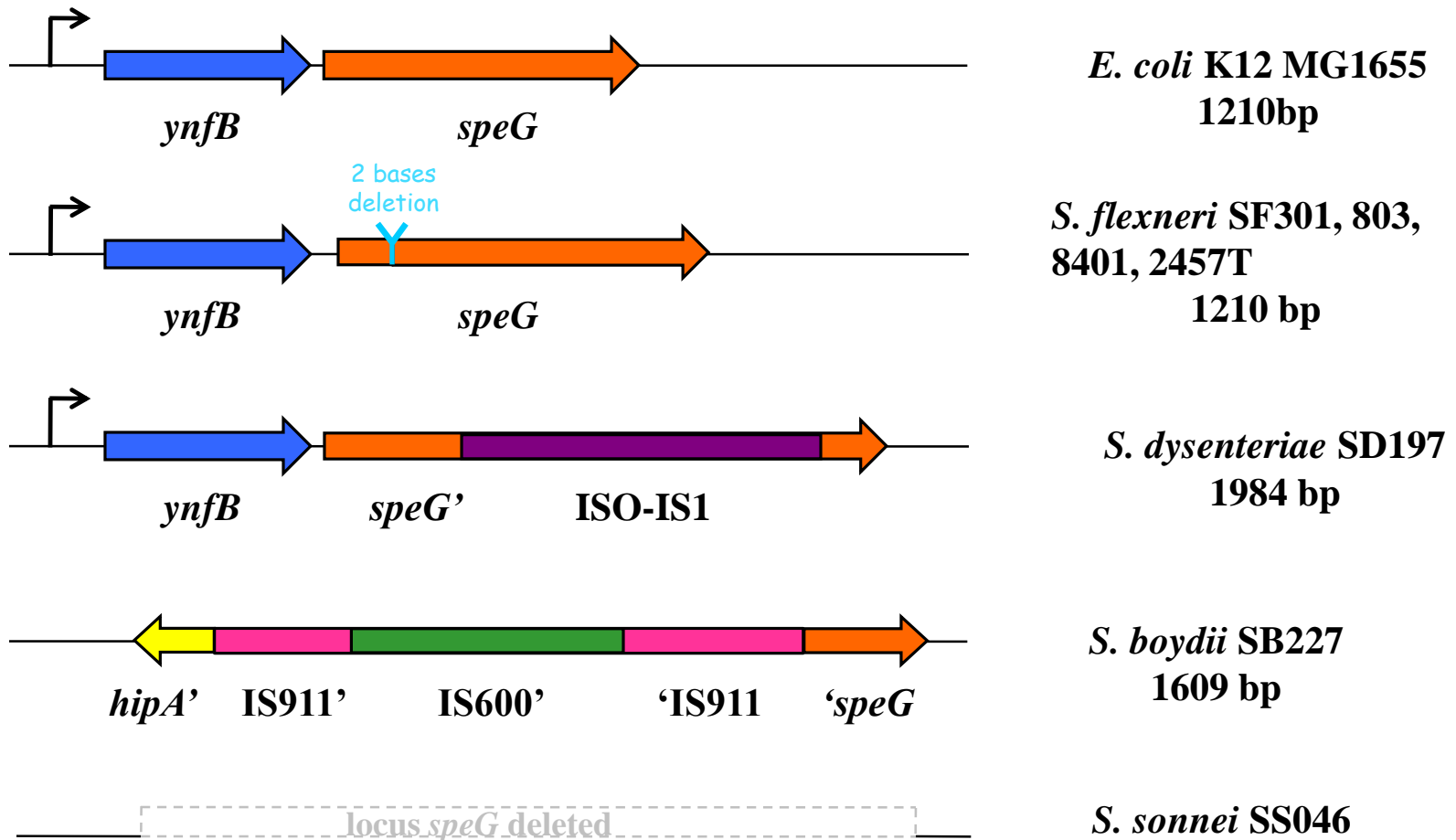
Gene	<i>S.flexneri</i>	<i>S.boydii</i>	<i>S.dysenteriae</i>	<i>S.sonnei</i>
<b>B1172</b>	Δ	Δ	Δ	Δ
<b>paal</b>	Δ	Δ	Δ	Δ
<b>sgcX</b>	Δ	Δ	Δ	Δ
<b>speG</b>	pseudogene	pseudogene	pseudogene	Δ
<b>yaaX</b>	Δ	Δ	Δ	Δ
<b>yahH</b>	Δ	Δ <b>speG</b>	Δ	Δ
<b>yaiX</b>	Δ	Δ	Δ	Δ
<b>ybhT</b>	Δ	Δ	Δ	Δ
<b>ycgM</b>	Δ	Δ	Δ	Δ
<b>yfeY</b>	Δ	Δ	Δ	Δ
<b>yghD</b>	Δ	Δ	Δ	Δ
<b>yniB</b>	Δ	Δ	Δ	Δ



- codes for spermidine acetyltransferase
- is up-regulated more than 5-fold in the presence of VirF

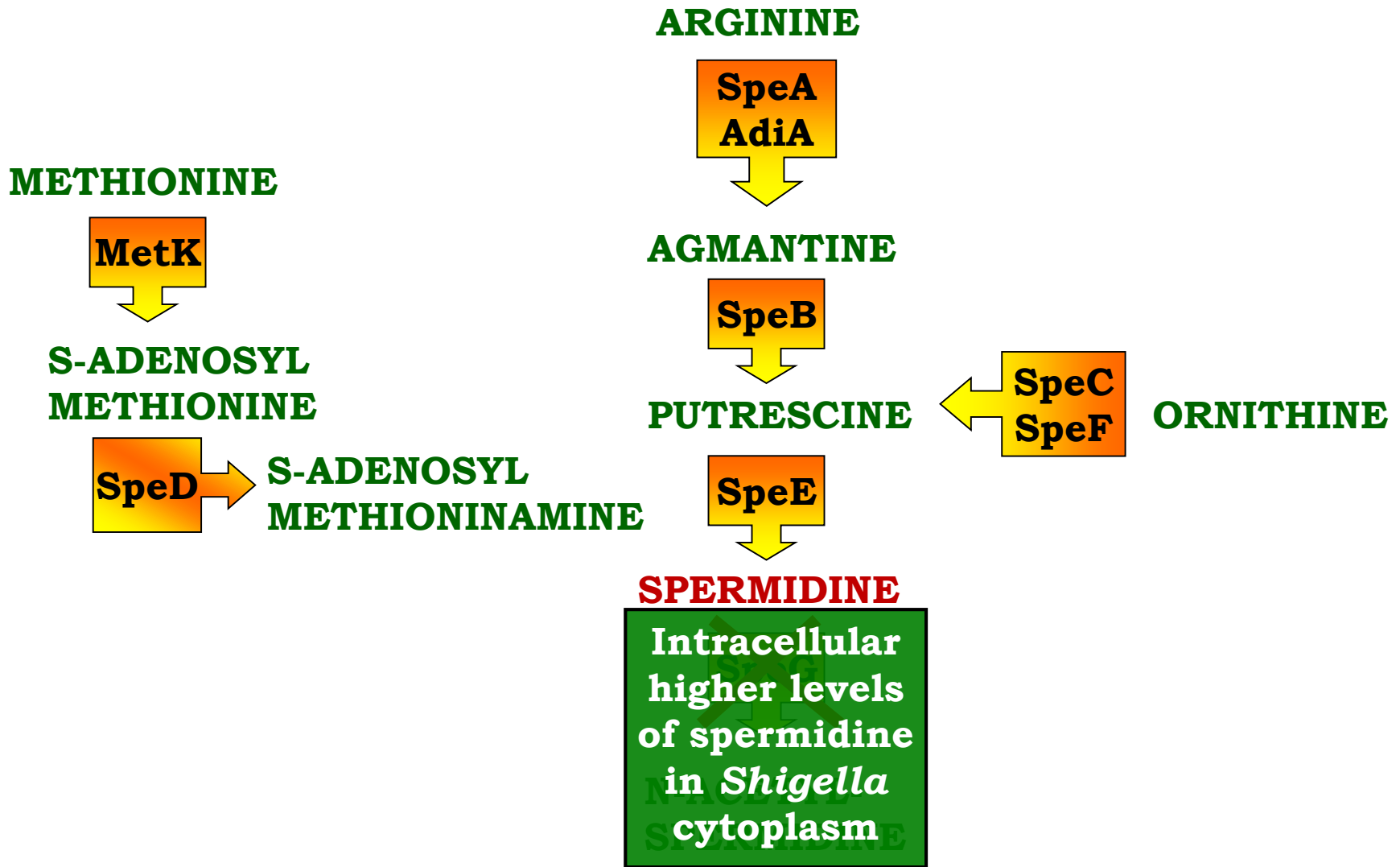
# Is *speG* inactivation conserved in all *Shigella* species?

## Molecular rearrangements of the *speG* locus



Convergent Evolution

# Spermidine Metabolism



# What is the effect of *speG* inactivation on *Shigella* fitness?

To answer this question we performed in vivo assays using derivatives of *S. flexneri* strain M90T:

deleted strain

**M90T *speE***  
defective *speE* gene  
which is unable to  
synthesize spermidine

**PUTRESCINE**



**SPERMIDINE**

complemented strains

**M90T pGP*speG***  
with functional *speG*  
gene under control of  
inducible promoter  
*P<sub>tac</sub>*

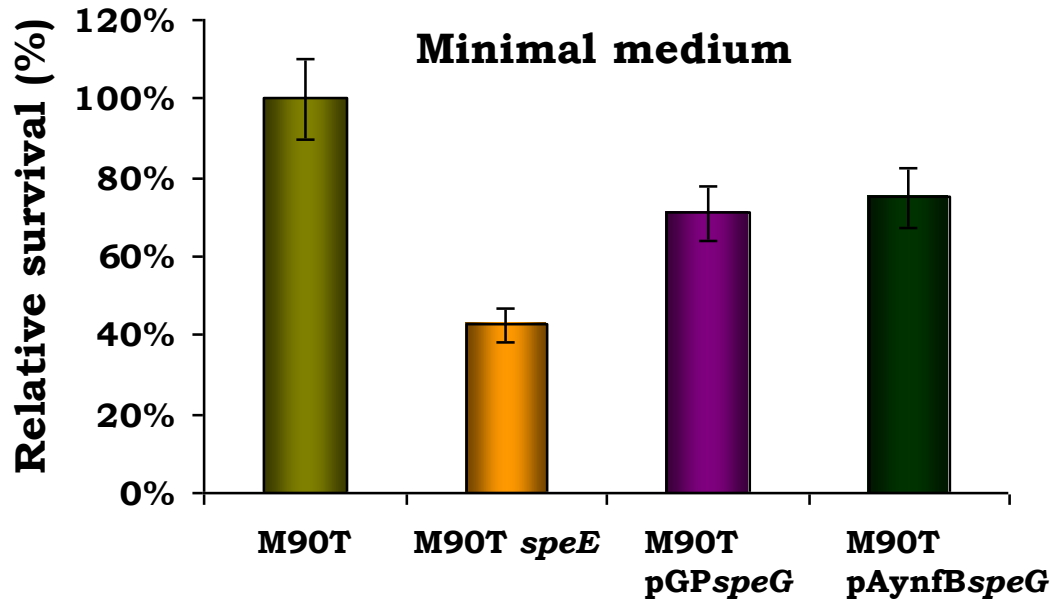
**M90T pACYC*speG***  
with the entire  
functional *ynfB-speG*  
operon with its own  
promoter

**SPERMIDINE**

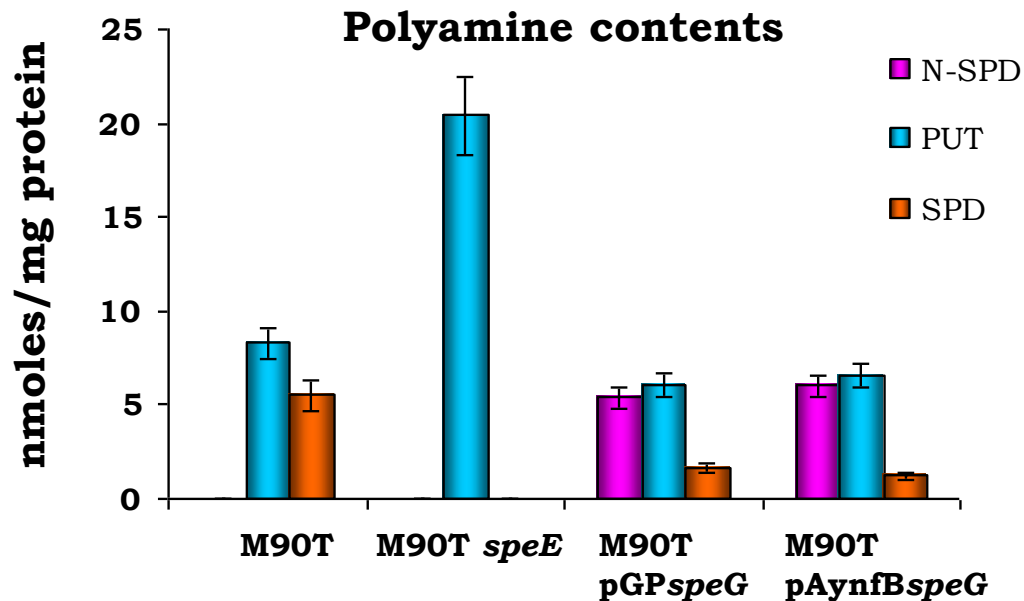


**N-ACETYL-  
SPERMIDINE**

# Spermidine accumulation increases resistance to oxidative stress



Oxidative stress assay with H<sub>2</sub>O<sub>2</sub> (5mM, 30min) on *S. flexneri* M90T reveals that the presence of *speG* reduces resistance to oxidative stress



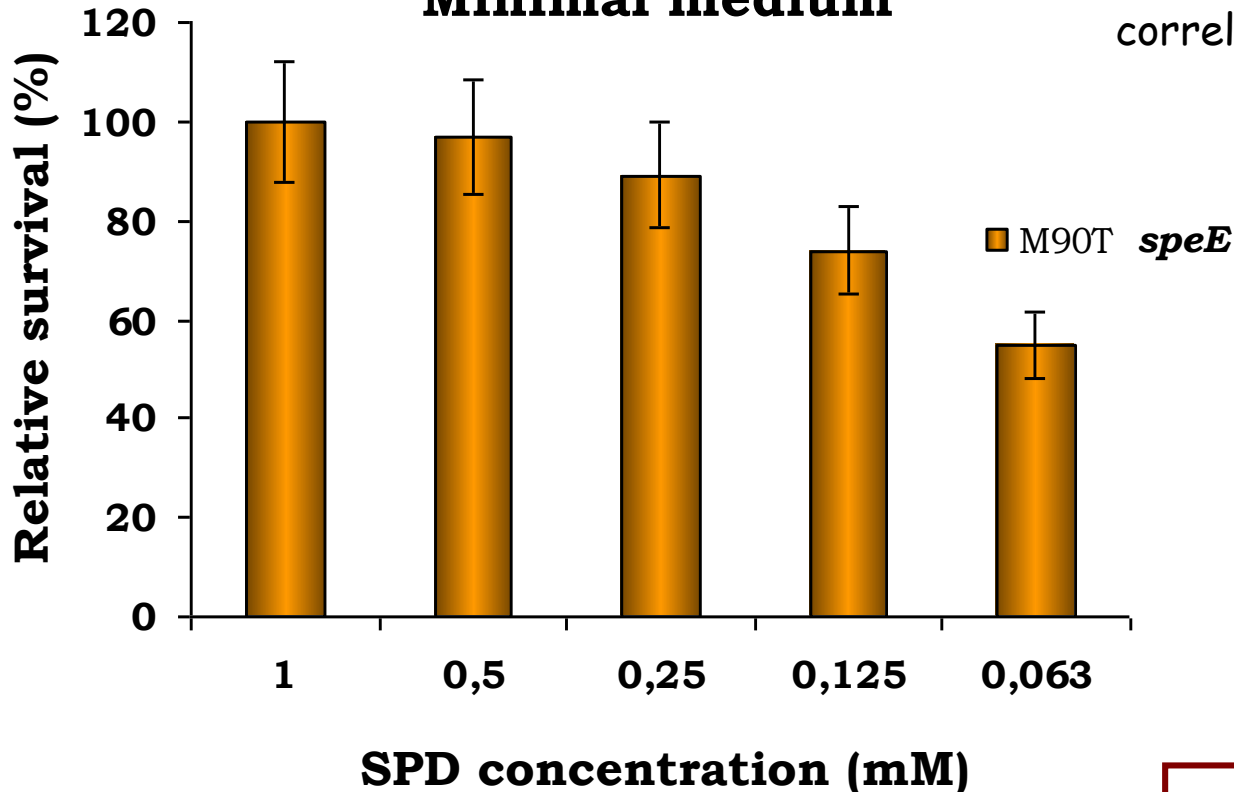
A reduced resistance to oxidative stress is paralleled by a decrease of intracellular spermidine



# Correlation between spermidine and oxidative stress

Oxidative stress assay with  $H_2O_2$  on strains unable to synthesize spermidine (*speE* defective) confirms that survival directly correlates with spermidine (SPD) concentration

## Minimal medium



*speG* inactivation improves *Shigella* fitness against oxidative stress

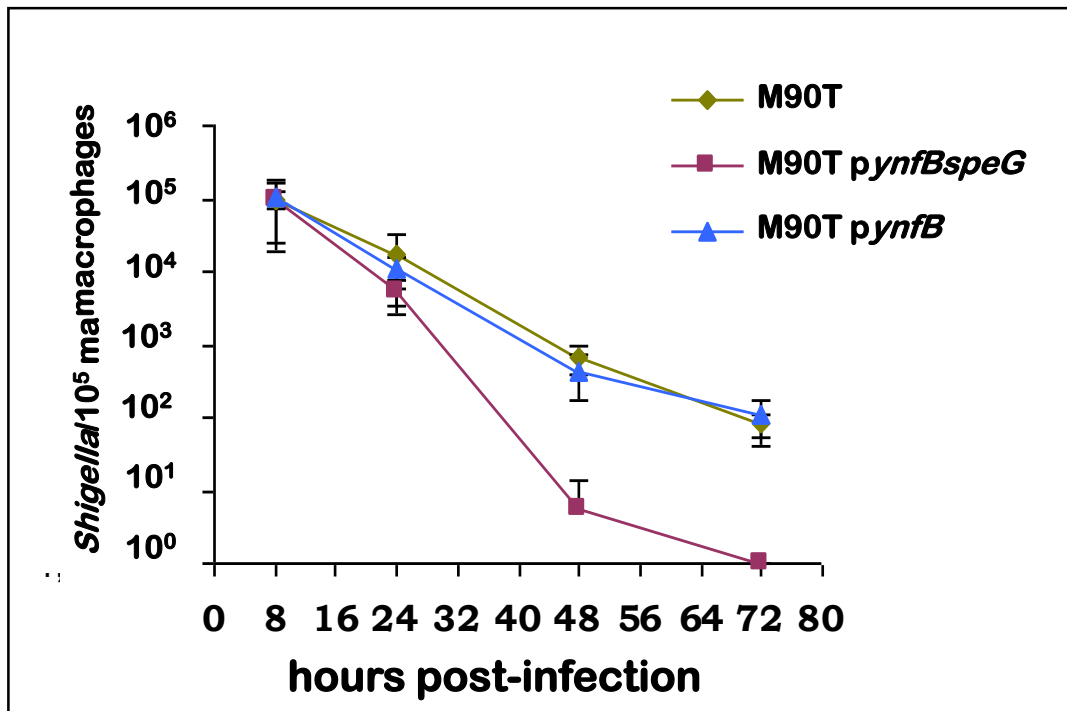
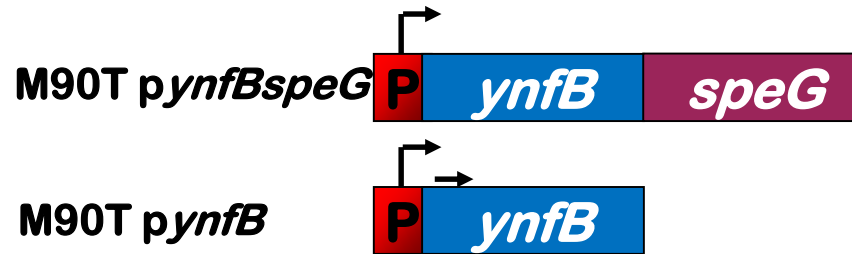
... so, *speG* inactivation improves the fitness of *Shigella* against environmental stresses ...

... but does *speG* inactivation improve the fitness of *Shigella* also inside the host?

# Intracellular survival of *S. flexneri*



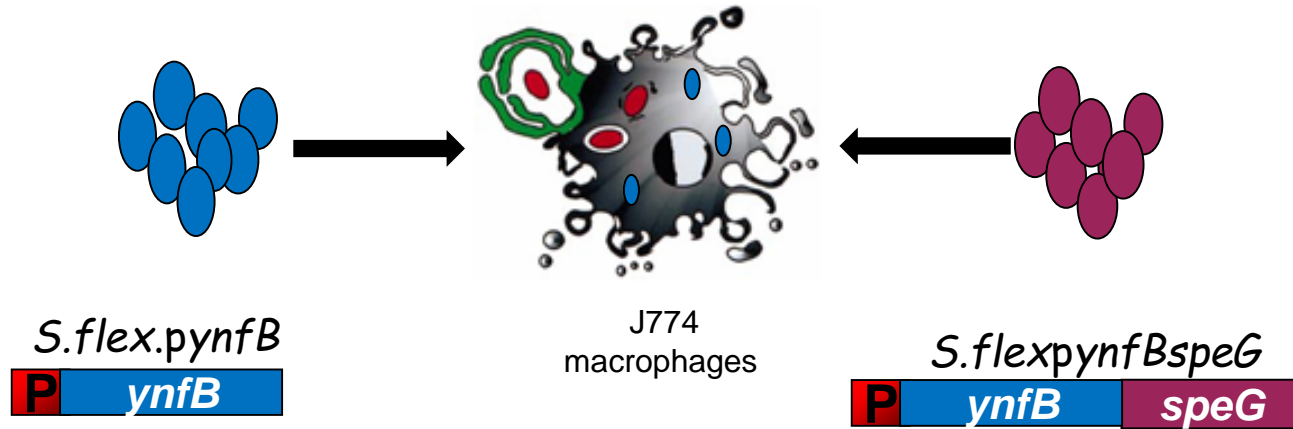
Intraperitoneal injection in BALB/c mice



P < 0,04

The introduction of the *speG* gene into *Shigella* reduces bacterial survival within macrophages

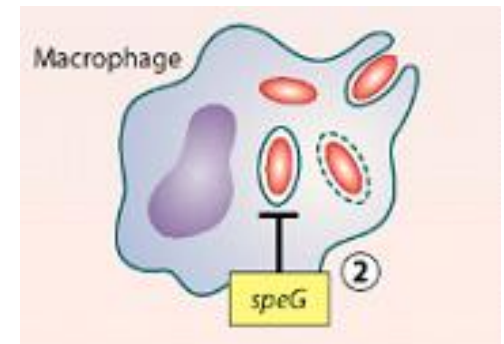
# Competitive infection between *S. flexneri* strains



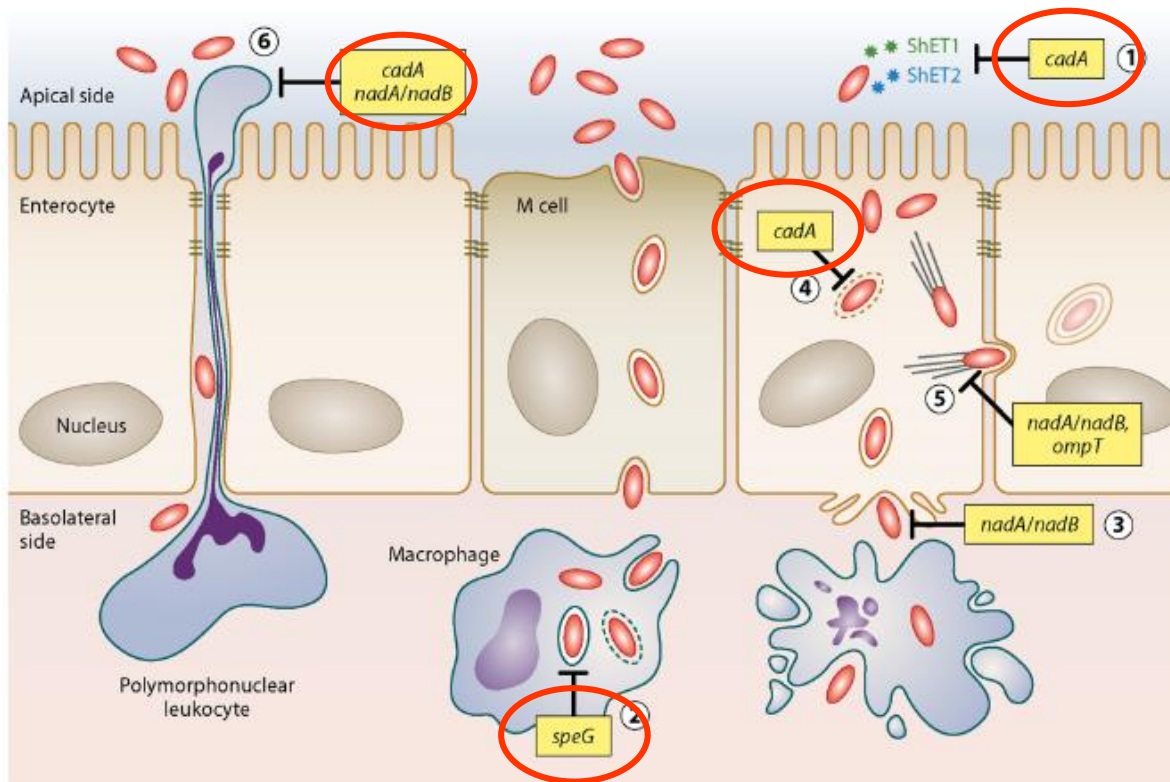
$$\text{C.I. (Competitive Index)} = \frac{S. flex + \text{P } ynfB \text{ speG}}{S. flex + \text{P } ynfB}$$

$\Rightarrow 0.7$  (1h)  
 $\Rightarrow 0.4$  (2h)

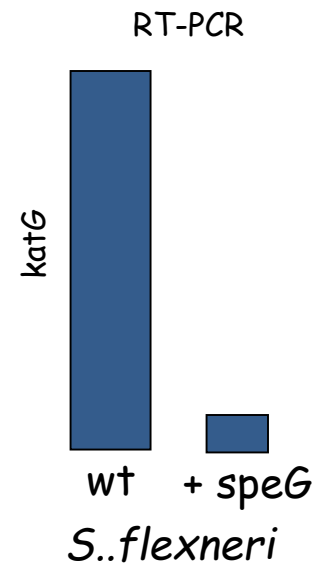
*speG* inactivation improves the survival within the macrophages



# Effect of polyamines to the *Shigella* invasive process



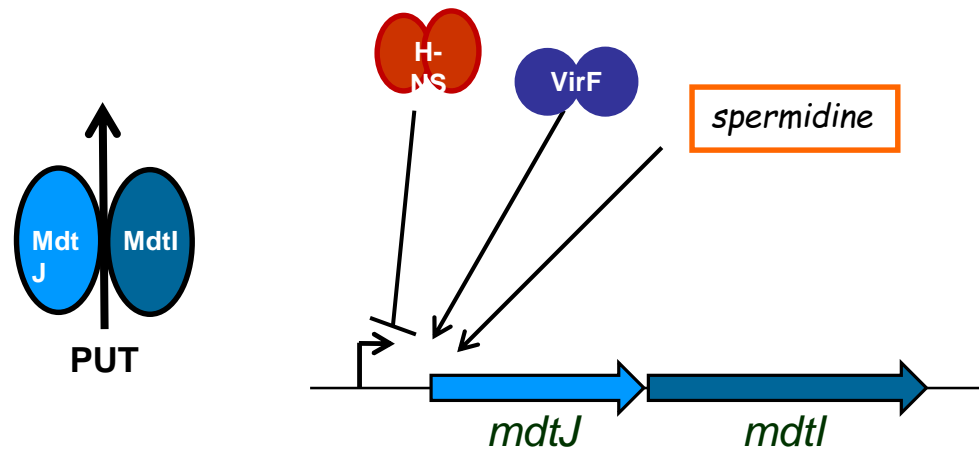
*speG* inactivation induces 8-fold overexpression of *katG* encoding hydroperoxidase I



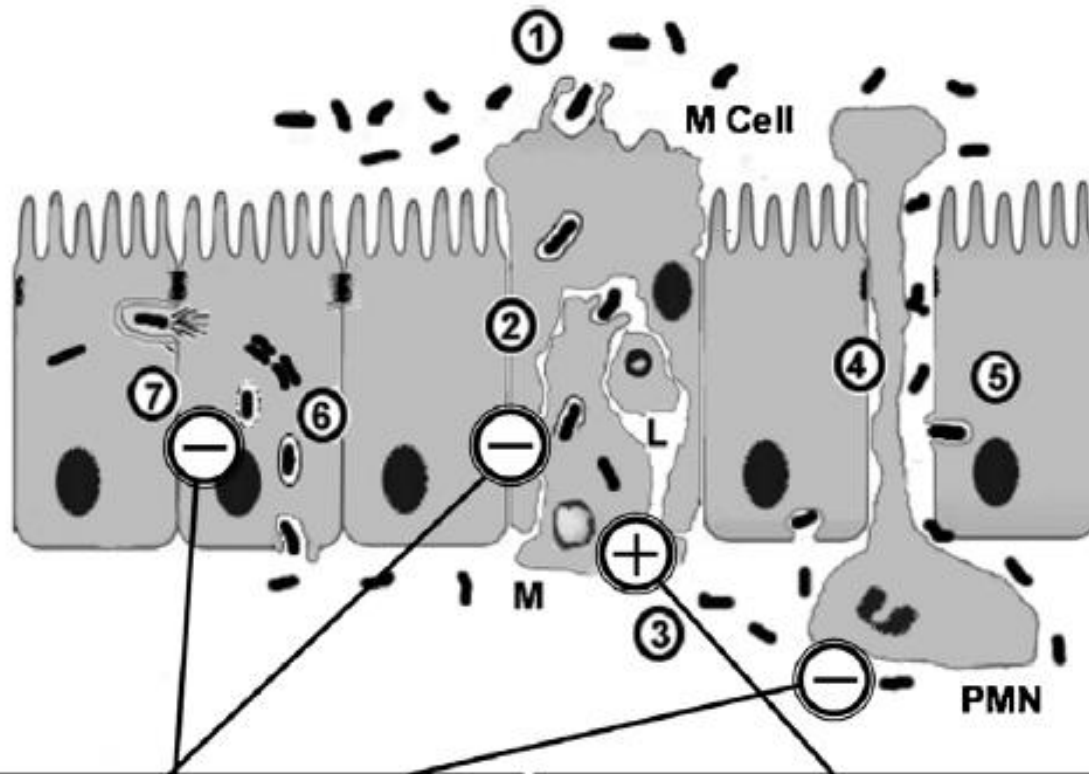
# Acquisition of VirF

- Activation of the plasmid virulence genes as a function of temperature
- Up-regulation of several genetic systems, some of which are probably involved in increasing the pathogenicity potential of the ancestral strain
- Deletion of genes whose up-regulation has a deleterious effect on cell survival or on the establishment of a fruitful host-pathogen interaction
- Activation of genes involved in the survival of *Shigella* in the presence of high spermidine level

VirF is able to activate the MtdJI efflux pump, which secretes putrescine, the precursor of spermidine.



# Effect of polyamines on the *Shigella* invasive process



## CADAVERINE INDUCES

- *Endosomal membrane stabilization*
- *Inhibition of PMN's migration*
- *Reduction of enterotoxicity*

## SPERMIDINE ACCUMULATION INCREASES

- *Survival in macrophages*
- *Resistance to oxidative stress*

## Acquisition of plasmid virF regulator

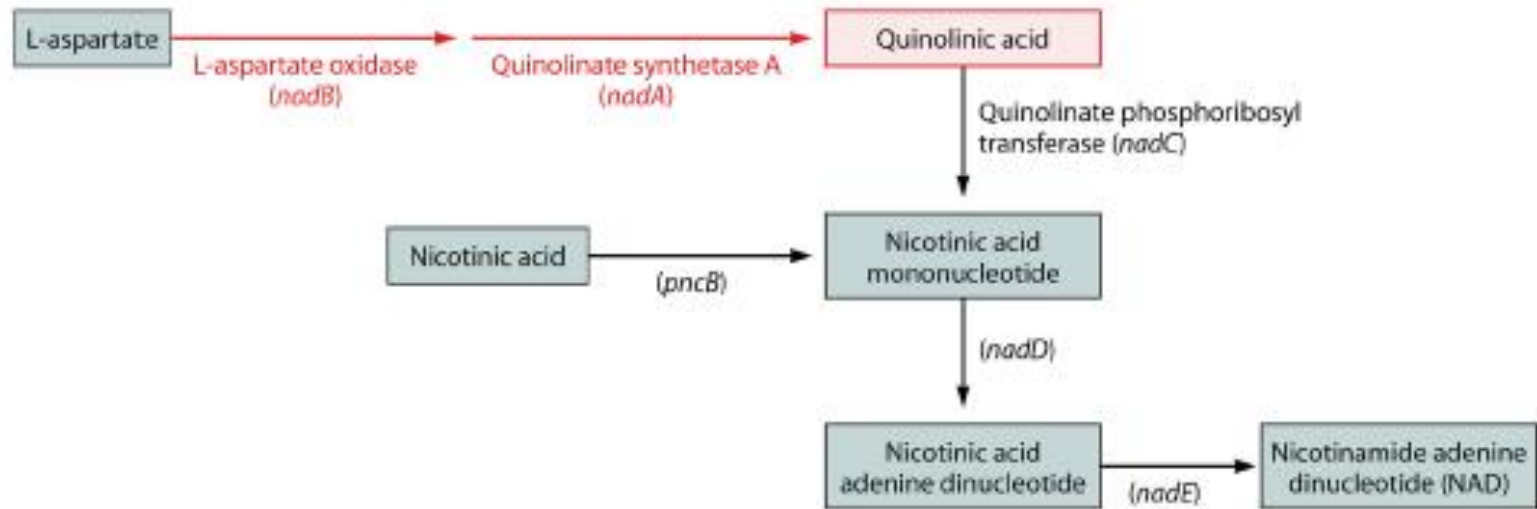
- Activation of the plasmid virulence genes as a function of temperature
- Up-regulation of several genetic systems, some of which are probably involved in increasing the pathogenicity potential of the ancestral strain
- Deletion of genes whose up-regulation has a deleterious effect on cell survival or on the establishment of a fruitful host-pathogen interaction
- Activation of genes involved in the survival of *Shigella* in the presence of high spermidine level



# Mutazioni patoadattative in *Shigella*

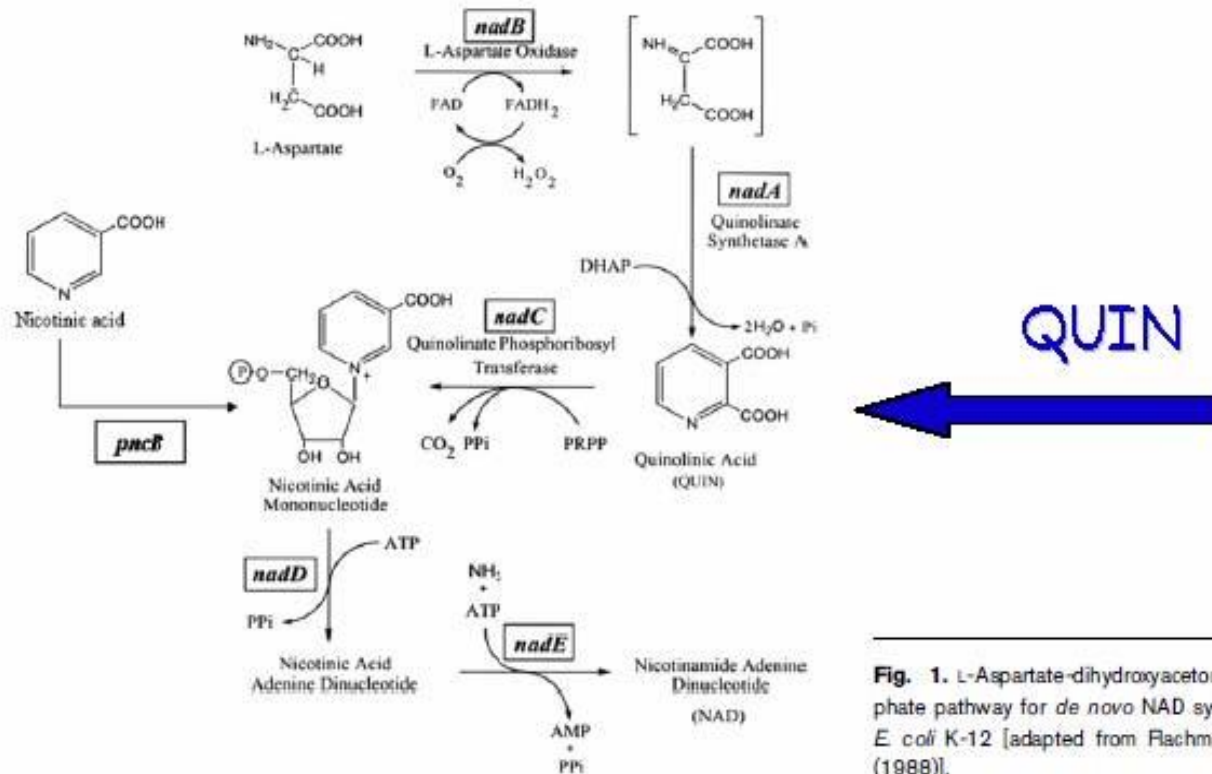
Antivirulence Genes	Biochemical activity	Antivirulence functions	Effects
<i>ompT</i>	Surface protease	Degradation of IcaA outer membrane protein	Inhibition of actin-based intracellular motility
<i>cadA</i>	Lysine decarboxylation	Synthesis of cadaverine	Attenuation of enterotoxicity; inhibition of PMNs migration; prevention of lysis of <i>Shigella</i> containing phagocytic vacuole
<i>nadA, nadB</i>	Synthesis of nicotinic Acid	Synthesis of QUIN	Prevention of intercellular spreading; reduction of PMNs migration; inhibition of T3SS-mediated secretion of IpaB and IpaC
<i>speG</i>	Spermidine Acetyl Transferase	Conversion of spermidine to acetyl-spermidine	Increased sensitivity to oxidative stress; reduction of intracellular survival in macrophages
<i>argT</i>	Transport of aminoacids	Not determined	Inhibition of invasion of HeLa cells
<i>flh</i>	Synthesis of flagella	Not determined	Potential activator of host immune system
<i>esg</i>	Synthesis of curli	Not determined	Potential activator of host immune system

# Another pathoadaptive mutation: the silencing of *nad* genes involved in the synthesis of nicotinic acid

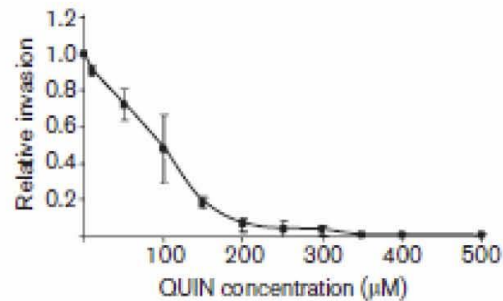


Quinolic acid (QUIN), the product of the *NadA/NadB* enzymatic reactions, inhibits both, invasion and intercellular spread of *Shigella*

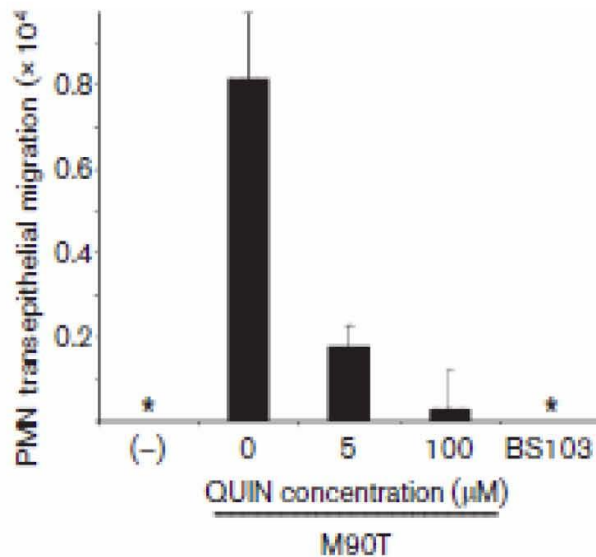
# I geni nad coinvolti nella sintesi dell'acido nicotinic



**Fig. 1.** L-Aspartate-dihydroxyacetone phosphate pathway for *de novo* NAD synthesis in *E. coli* K-12 [adapted from Flachmann *et al.* (1988)].



**Fig. 2.** Effect of QUIN on invasion of HeLa cells by M90T measured by the gentamicin protection assay. Percentages invasion

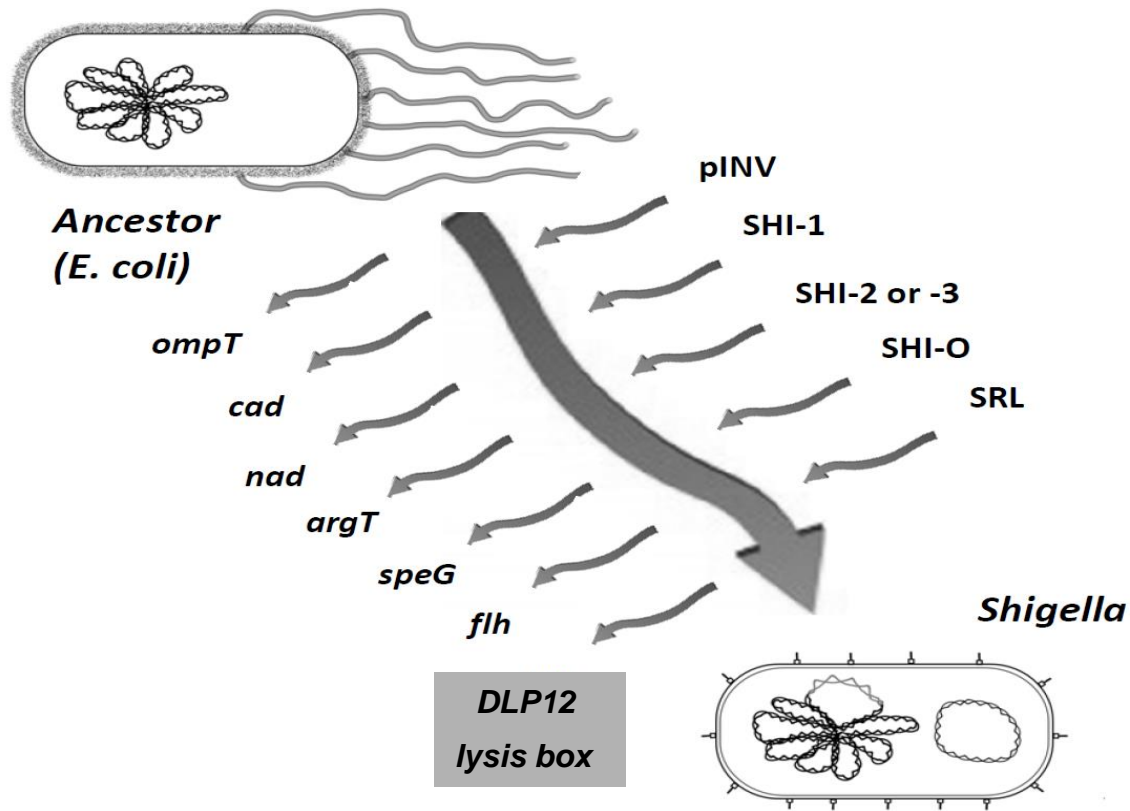


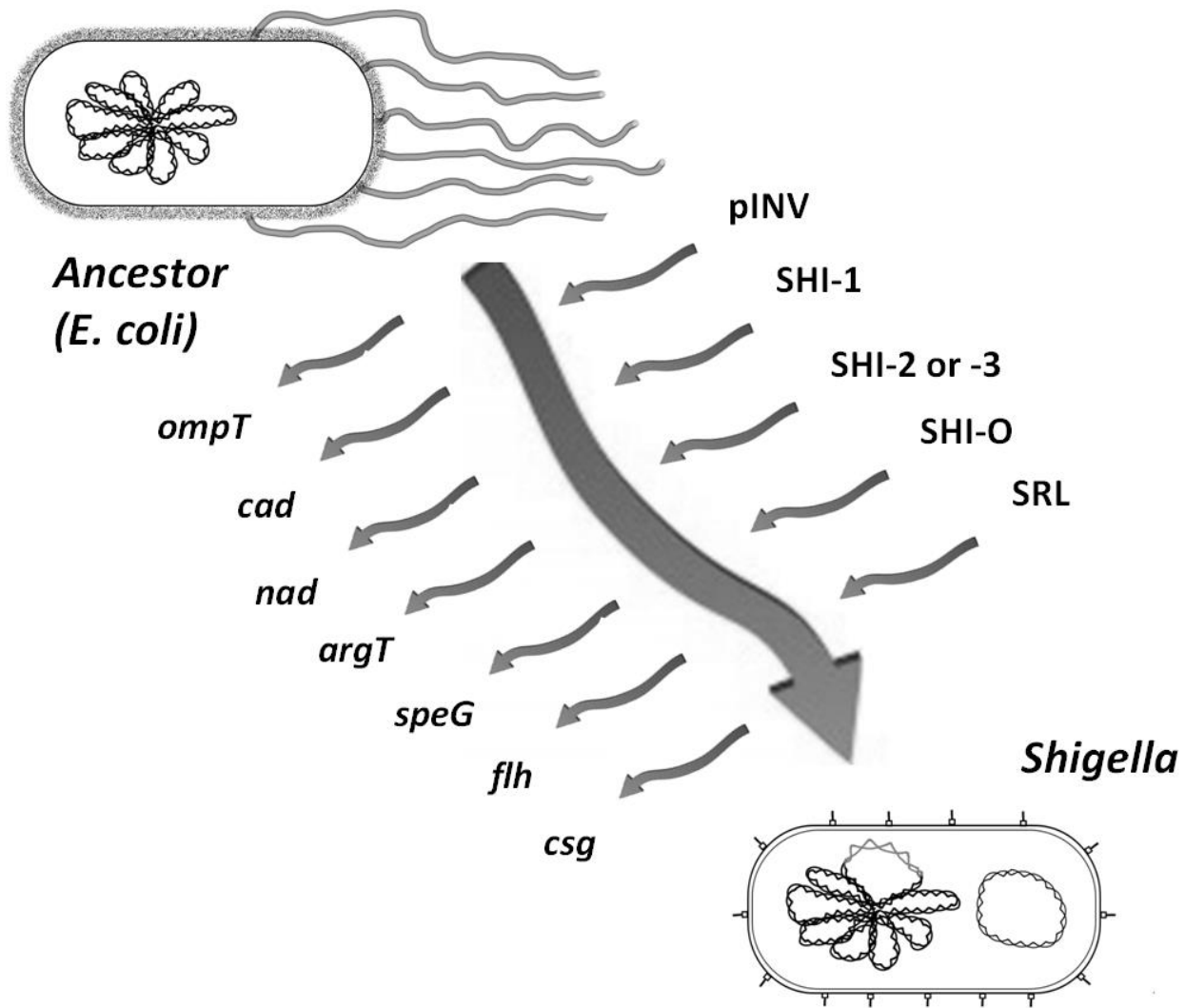
Il QUIN un intermedio nella sintesi dell'acido nicotico interferisce nel processo di invasività di *Shigella* sia a livello dell'efficienza di invasione che nella trasmigrazione dei PMN verso il sito d'infezione

## Examples of genetic rearrangements in the nad BA genes: another case of convergent evolution

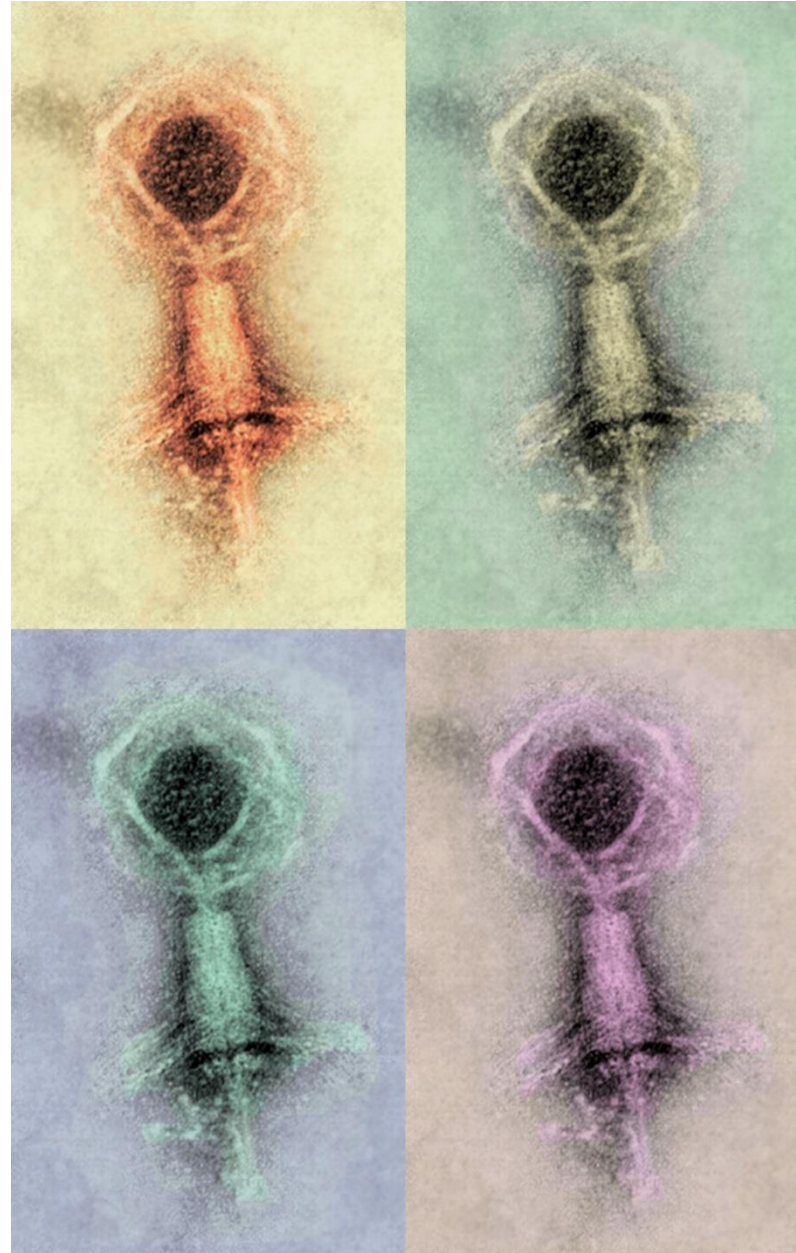
<i>S. flexneri</i> 2457T	2a	3	A111V, C128Y, T252A, Q271R, G304D	<a href="#">AF403415</a>	R80H, Q95P, (I108V, E141Q, T142S, L149Q), C354*, (D415G, I416V)	<a href="#">AF403416</a>	4
<i>S. flexneri</i> BS510	3a	3	None	<a href="#">EF473659</a>	A73S, (I108V, E141Q, T142S, L149Q), C354*, (D415G, I416V)	<a href="#">EF473668</a>	CDC
<i>S. flexneri</i> M90T	5a	3	A111V, T252A	<a href="#">EF473666</a>	R80H, Q95P, (I108V, E141Q, T142S, L149Q), C354*, (D415G, I416V)	<a href="#">EF473657</a>	21
<i>S. dysenteriae</i> 197	1	Outlier	R134H, (G191A), P219L, R257W	<a href="#">NC_007606</a>	(V167I), D218N, (D415G, I416V)	<a href="#">NC_007606</a>	25
<i>S. dysenteriae</i> BS681	8	Outlier	none	<a href="#">EF473662</a>	G44V, (I108V, E141Q, L149Q), V180I, (Y412D, D415G, I416V)	<a href="#">EF473671</a>	CDC
<i>S. sonnei</i> BS513 <i>E. coli</i> (EIEC) strains	NA <sup>e</sup>	Outlier	IS21 between aa 292 and 293	<a href="#">EF473661</a>	IS600 in codon 233	<a href="#">EF473670</a>	CDC
EDL1284	O124	NA	G198S, V260G	<a href="#">EF473665</a>	Portion of IS600 after aa 52; deletion aa 53 to 192	<a href="#">EF473674</a>	Z
<i>E. coli</i> (EIEC) strain 1	O136	NA	G198S	<a href="#">EF473664</a>	IS600 between aa 52 and 53	<a href="#">EF473673</a>	L. Trabulsi

The long path of *Shigella* towards pathogenicity may involve more pathoadaptive mutations.....





Phages and virulence or  
.....antivirulence?

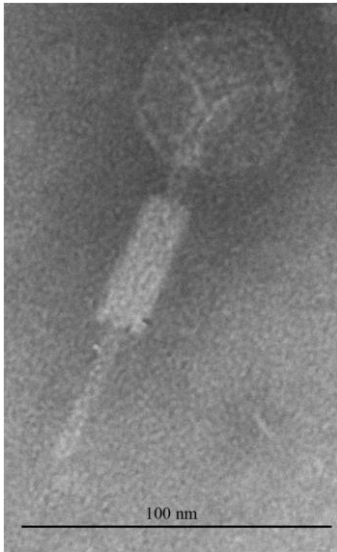




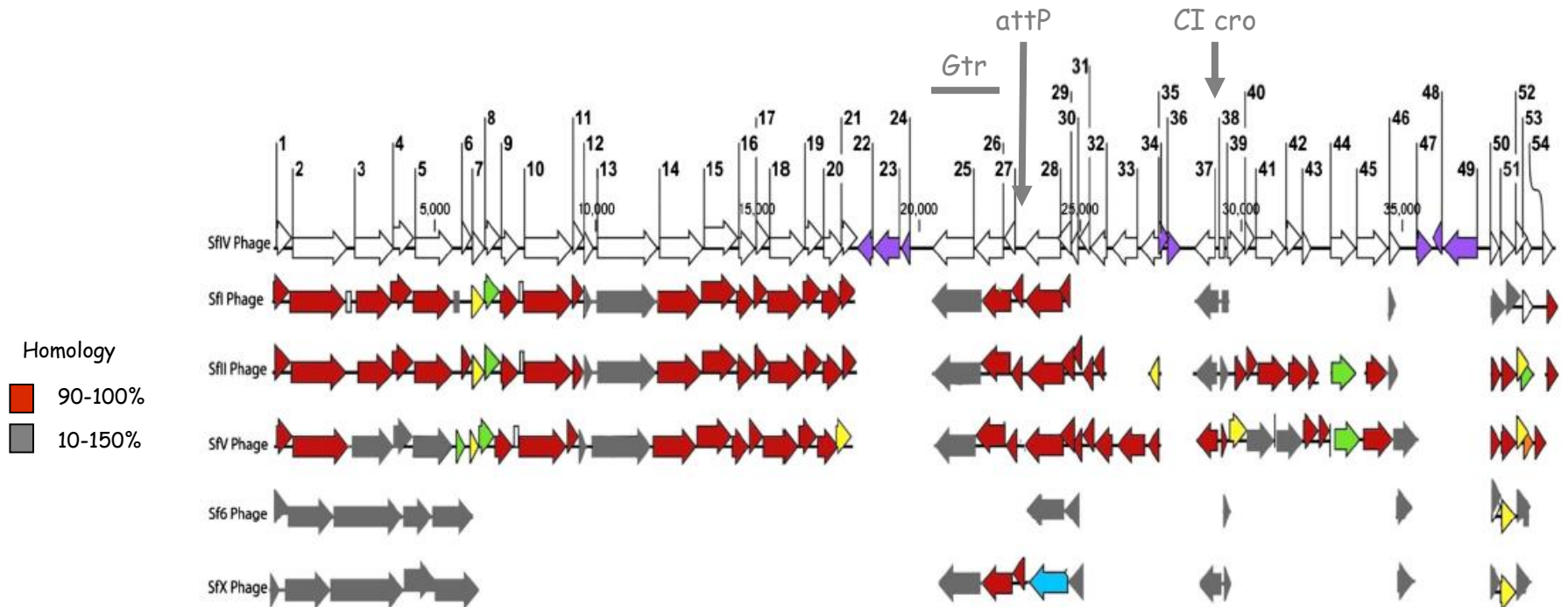
# Phages and O-antigen in *Shigella*

Several serotype-converting phages (SfI) have been isolated in *Shigella*. They contain genes encoding glucosyltransferase and/or acetyltransferase, responsible for the modification of the O-antigen.

Two genes - *gtrA* and *gtrB* - are well conserved. They encode proteins involved in the transfer of the glucosyl group, while the third gene (encoding glucosyltransferase) is serotype-specific.



SfIV phage

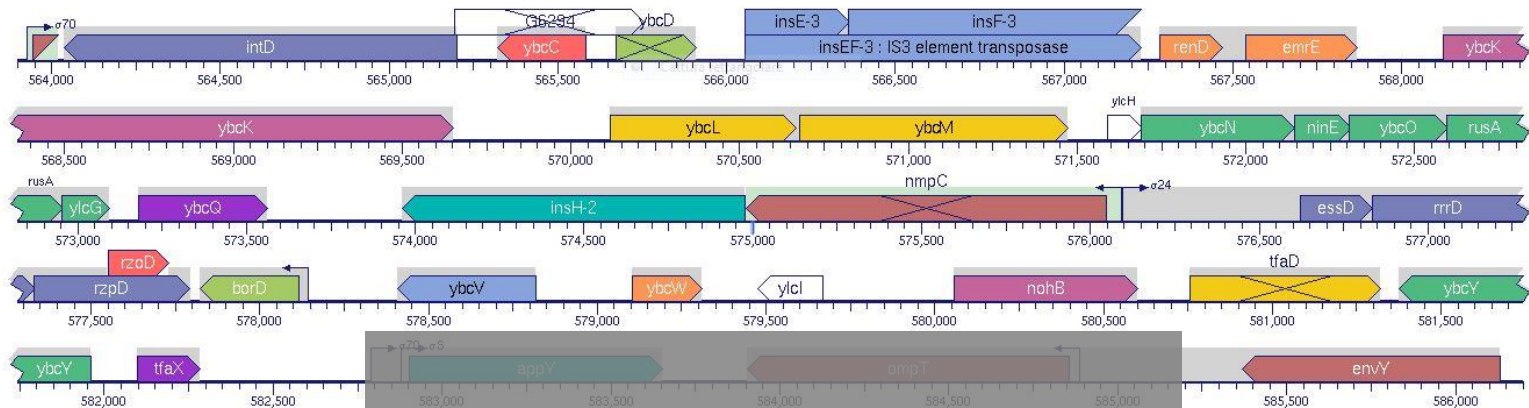


# DLP12: an antivirulent prophage?

DLP12 :

- is a **Defective Lambdoid Prophage** integrated at 12 min in *E. coli* chromosome

Within its genome DLP12 carries the gene encoding the OmpT protease

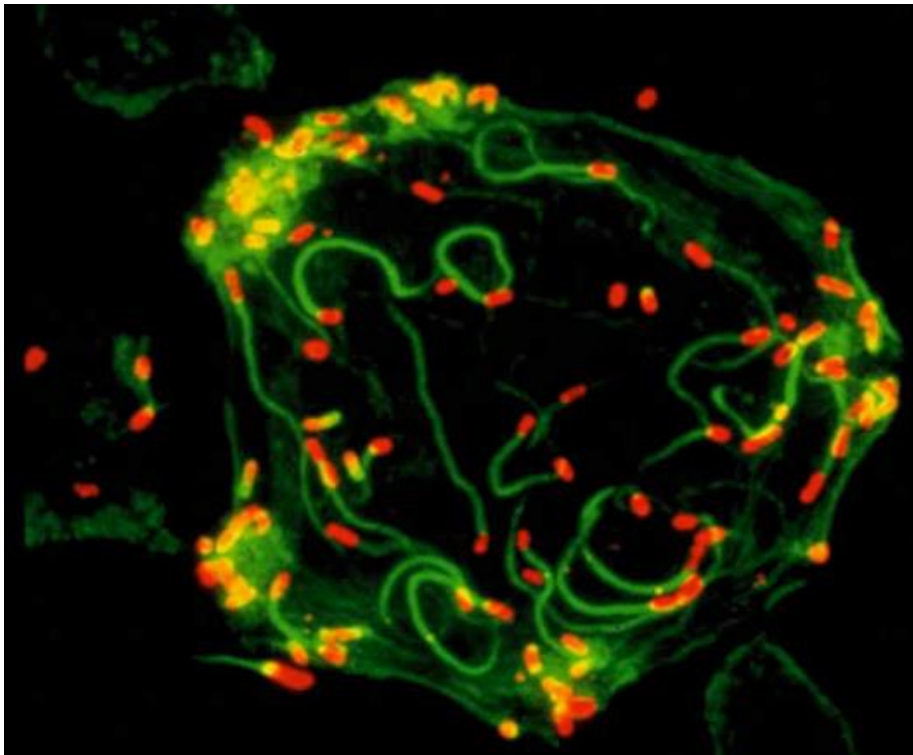


Loss of OmpT protease

All *Shigella* and EIEC strains have lost the OmpT encoding gene

# Motility of *Shigella* is mediated by plasmid-encoded protein IcsA

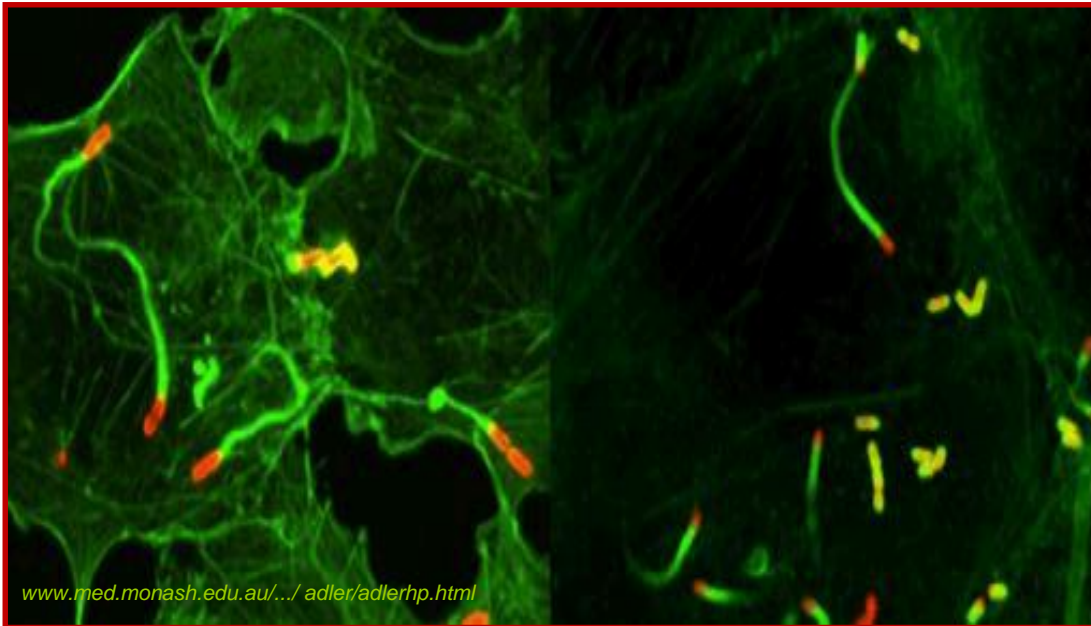
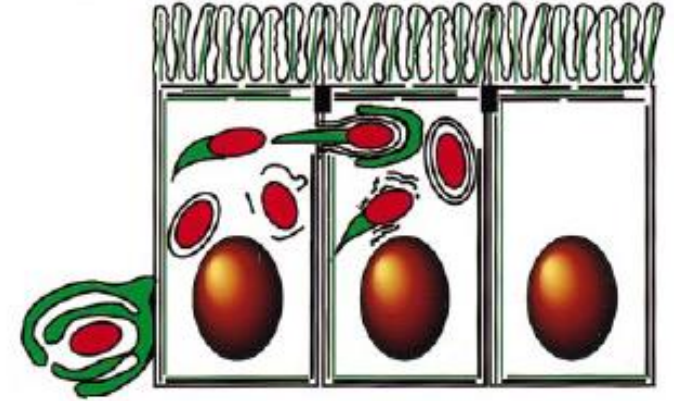
*Shigella* is able to infect epithelial cells, and to move intra- and inter-cellularly, using an actin-mediated motility



IcsA induces a rearrangement of the host cytoskeleton by assembling actin tails at one pole of bacterium

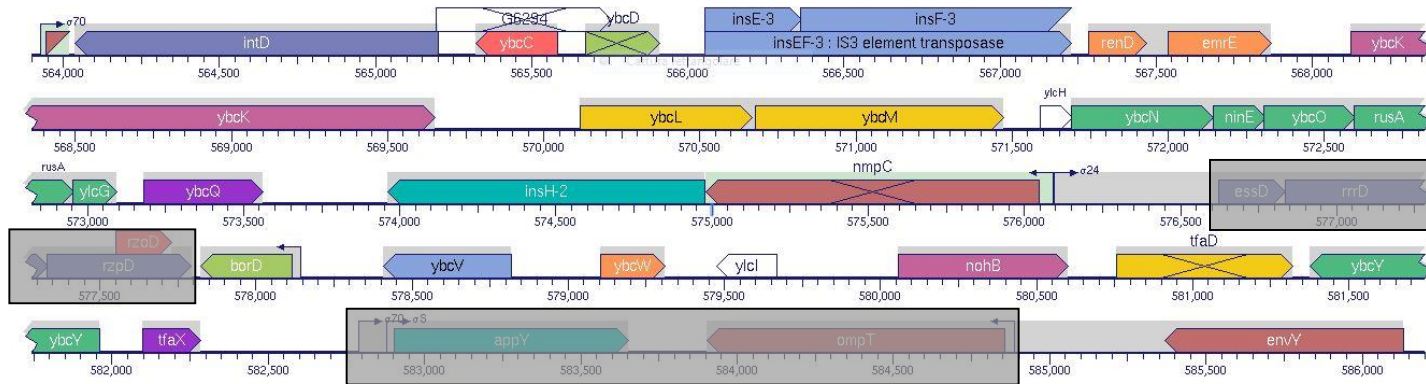
# The loss of the OmpT protease is a pathoadaptive mutation in *Shigella*

The absence of OmpT, a surface protease, is an essential requirement for the ability of *Shigella* to spread intra- and inter-cellularly

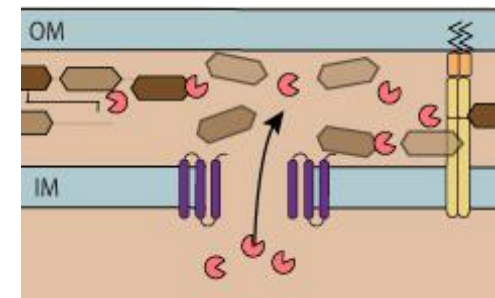
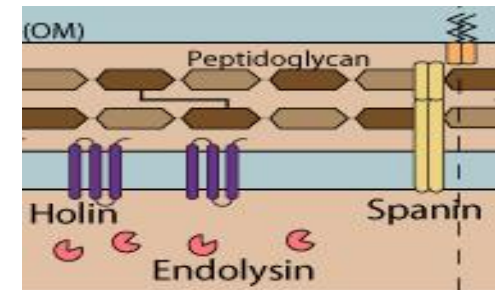
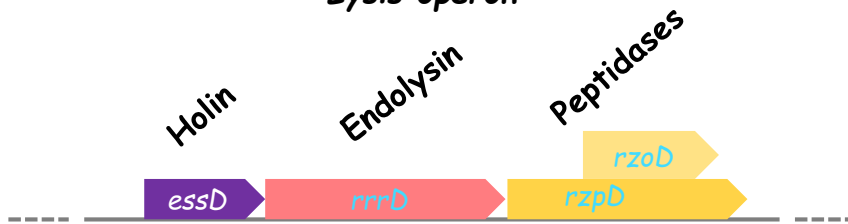


OmpT degrades the *Shigella* IcsA protein which is responsible for the formation of the actin tails at one pole of the bacterial cell

# .....not only *ompT* but also the DLP12 genes encoding the Holin/Endolysin system are lost in *Shigella*



## Lysis operon



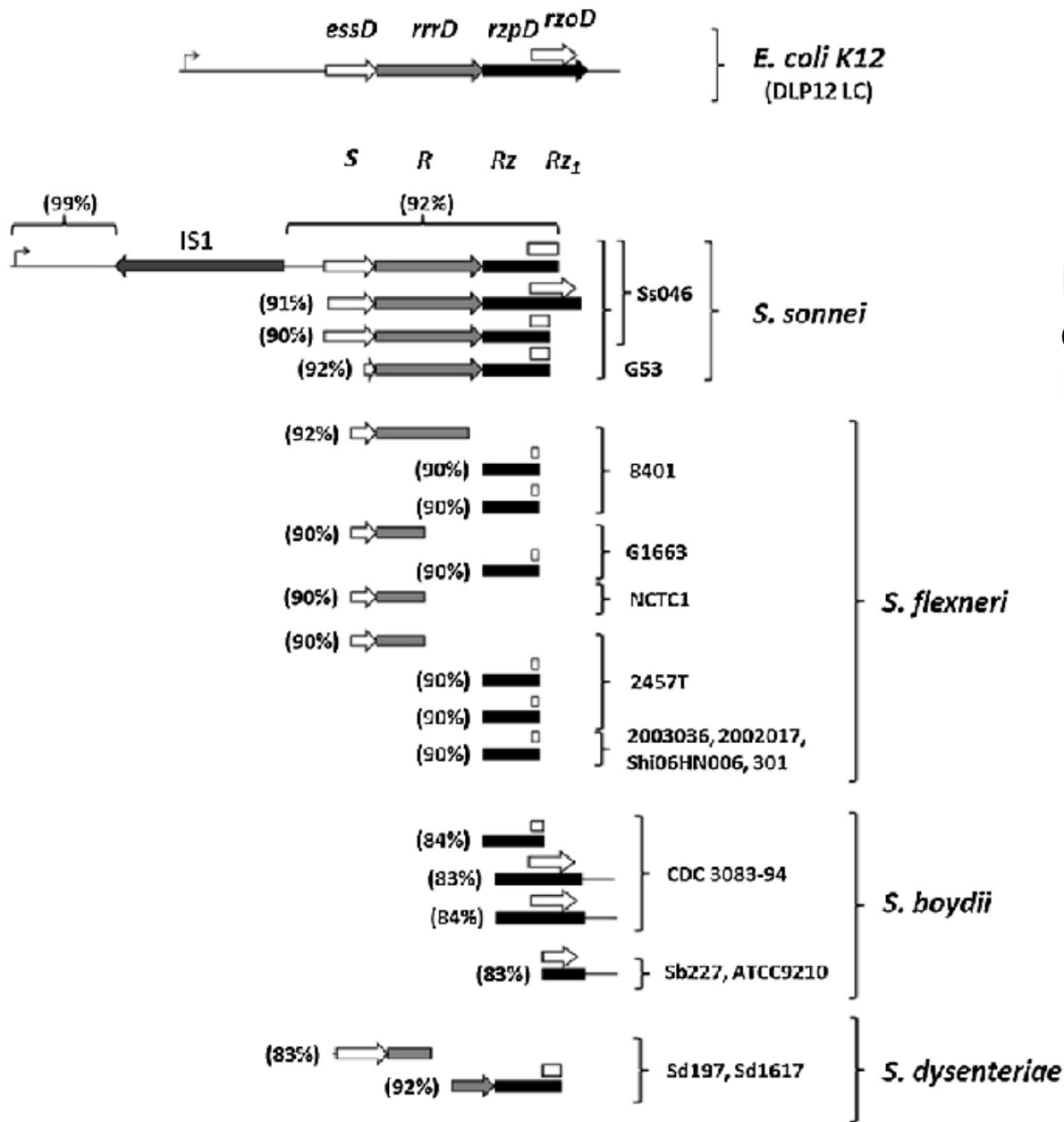
The Holin / Endolysin system of DLP12 has been "adopted" by *E.coli* and appears to be involved in remodelling of peptidoglycan during cell division and in the release of not recyclable PNG fragments

## ***Il sistema lisina endolisina dei fagi***

Il gene *S* codifica per oolina, una proteina che crea dei pori nella membrana e per il suo inibitore trascrizionale che ne diminuisce la concentrazione, il gene *R* codifica per l'endolisina l'enzima che degrada i legami glicosidici del peptidoglicano mentre *RZ* e *RZ1* codificano per proteine coinvolte nella rottura dei legami peptidici del peptidoglicano

La cassetta *LC* è conservata nei fagi lisogenici di *E. coli* DLP12, Sp5, Sp6 e ha elevata omologia con la cassetta di Lisi dei fagi P21 e P1.

La cassetta *LC* di DPL12 è stata addomesticata da *E. coli* e utilizzata nel mantenimento della parete cellulare e nella formazione dei biofilm.

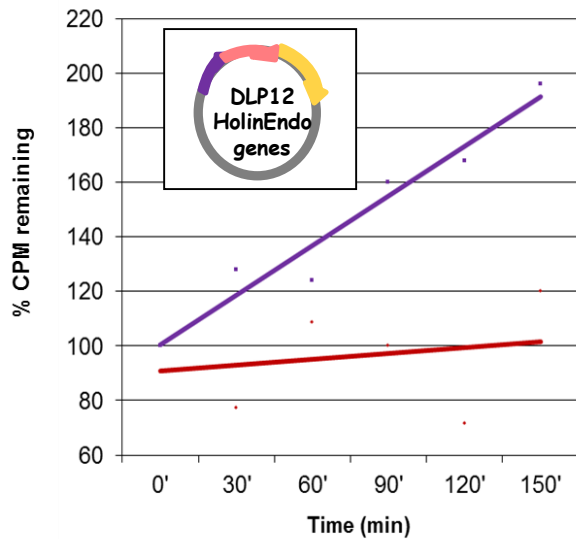


Riarrangiamenti nella cassetta di lisi DLP 12 In *Shigella*

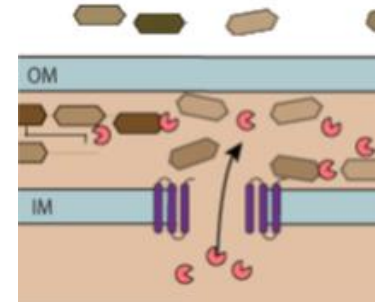
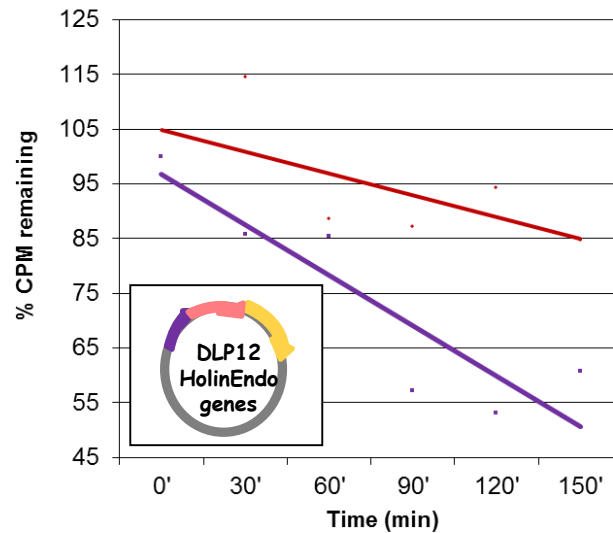
# Does the introduction of Holin/Endolysin of DLP12 prophage into *S. flexneri* increase the release of peptidoglycan components ?

## [6-<sup>3</sup>H] Glucosamine Peptidoglycan assay

Supernatants of *S. flexneri* pLys12 (■) vs *S. flexneri* vector (■)



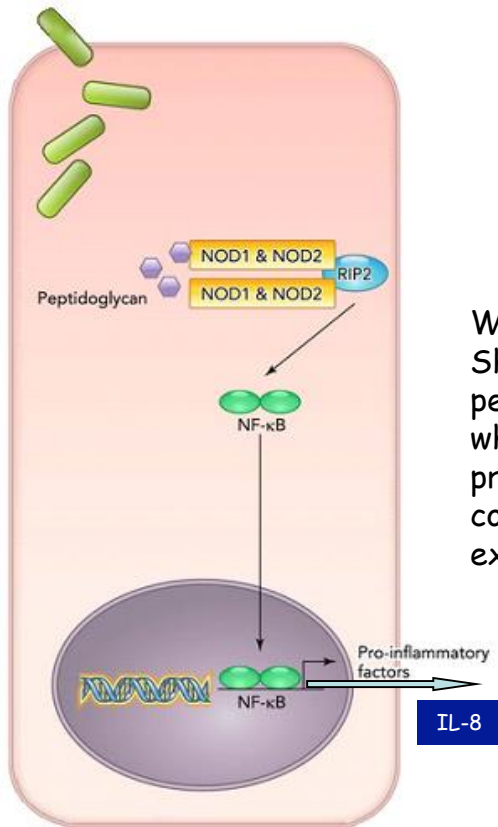
Pellets of *S. flexneri* pLys12 (■) vs *S. flexneri* vector (■)



There is a strong increase of labelled peptidoglycan fragments in the supernatant of *Shigella* strains expressing the Holin/Endolysin system

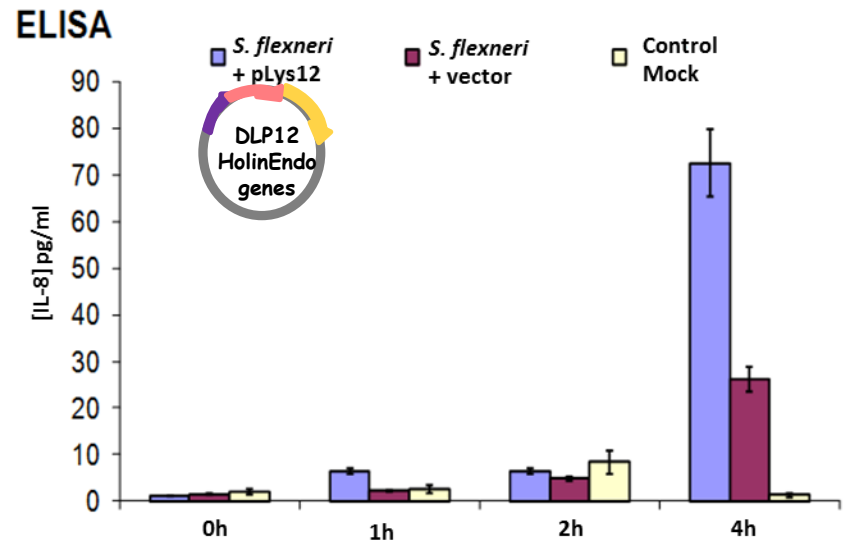
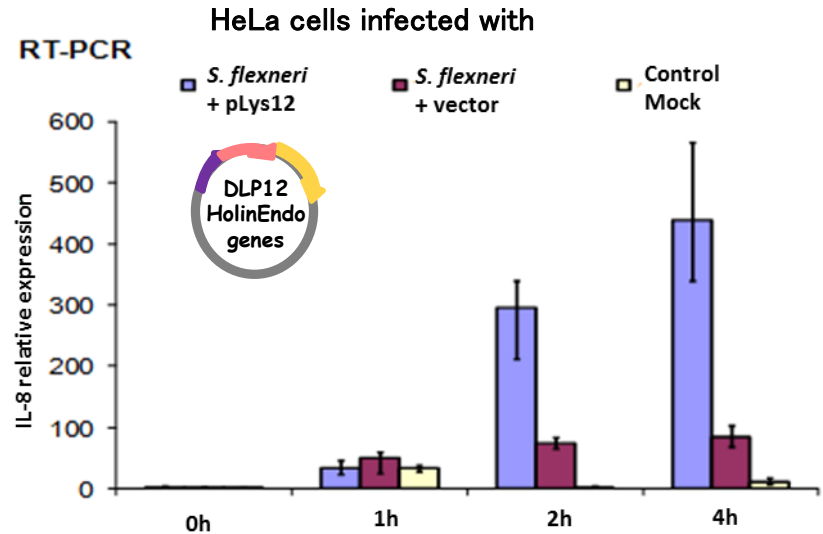


# Is the loss of the Holin / Endolysin System of DLP12 prophage a strategy to reduce the inflammatory response of the host?



Within epithelial cells *Shigella* releases peptidoglycan fragments which activate Nod1/2 proteins and, as a consequence, induce IL-8 expression

The introduction of the pLys12 plasmid, carrying the Holin / Endolysin system of DLP12, leads to a strong increase of IL-8 and to the subsequent stimulation of the host immune response.





The long path of *Shigella* towards pathogenicity may involve more pathoadaptive mutations.....

